

ESO Libraries



ML 1993 004331



Svend Laustsen
Claus Madsen
Richard M. West

EXPLORING THE SOUTHERN SKY

A Pictorial Atlas from the
European Southern Observatory (ESO)

With 240 Photographs, Partly in Colour,
31 Diagrams and a Fold-out Plate



Springer-Verlag
Berlin Heidelberg New York
London Paris Tokyo

SVEND LAUSTSEN
CLAUS MADSEN
RICHARD M. WEST

European Southern Observatory (ESO)
Karl-Schwarzschild-Straße 2
D-8046 Garching bei München

ISBN 3-540-17735-3 Springer-Verlag Berlin Heidelberg New York
ISBN 0-387-17735-3 Springer-Verlag New York Berlin Heidelberg

This work is subject to copyright. All rights are reserved, whether the whole or part of the material is concerned, specifically the rights of translation, reprinting, re-use of illustrations, recitation, broadcasting, reproduction on microfilms or in other ways, and storage in data banks. Duplication of this publication or parts thereof is only permitted under the provisions of the German Copyright Law of September 9, 1965, in its version of June 24, 1985, and a copyright fee must always be paid. Violations fall under the prosecution act of the German Copyright Law.

© Springer-Verlag Berlin Heidelberg 1987

Printed in Germany

Reproduction of the plates and figures:
Chemigraphia, Gebrüder Czech, München

Typesetting and printing:
Universitätsdruckerei H. Stürtz AG, Würzburg

Bookbinding:
Buchbinderei Sigloch, Künzelsau

2124/3130-543210

Foreword

The photographs in this book combine beauty and scientific relevance. The characteristics of the galaxies, nebulae and other objects shown have been determined by the physical laws which govern their destiny, but the resulting shapes and colours have a profound aesthetic appeal.

Astronomical research has begun to give us some idea as to how the Universe evolved. Starting from a condition of extremely high density and temperature, an expanding Universe originated some twenty thousand million years ago. What preceded this stage is beyond the limits of our knowledge. In this expanding Universe multitudes of stars and galaxies formed. Studying them in detail allows us to push the limits of our knowledge even further back in space and time, and thereby to come closer to the mysterious moment of the origin of the Universe. Along the way we may also learn much about physics under conditions very different from those encountered on earth.

Many questions remain to be answered. How did the galaxies form? How did our solar system originate? No one can answer the former question with confidence, while only preliminary ideas have been developed about the latter. The detailed study of the objects shown in this book should help us to search for more definite answers.

The photographs that appear in this book have been taken with the telescopes of ESO, the European Southern Observatory, a cooperative venture of eight countries, Belgium, Denmark, France, Germany, Italy, the Netherlands, Sweden and Switzerland. ESO's telescopes are located at La Silla, a 2400 meter high mountain in the Atacama desert in northern Chile, where the skies are of an extraordinary purity and transparency. The ESO Headquarters for research and technological development is in Garching near München. This book demonstrates the fruits of international cooperation in science.

L. Woltjer
Director General of ESO

Table of Contents

Introduction	1	3 Minor Bodies in the Solar System	193
A Guide to this Book	2	3.1 Meteoroids and Minor Planets	194
1 The Universe and its Galaxies	5	3.2 Comets	205
1.1 A Look into Fornax	8	4 The Southern Sky and ESO	221
1.2 An Ordered Sequence of Galaxies	15	4.1 A European Organization for	
1.3 The Local Group	47	Astronomy	223
1.4 The Sculptor Group	69	4.2 The La Silla Observatory	223
1.5 Multiple Galaxies	74	4.3 The Headquarters in Garching	247
1.6 Clusters of Galaxies	87	4.4 The Next Generation of Telescopes	250
1.7 Peculiar Galaxies	99		
2 The Milky Way Galaxy	117	Glossary	257
2.1 Panorama of the Milky Way	119	Plate Data	263
2.2 The Milky Way from Orion to Pup-		Index of Objects	271
pis	124		
2.3 The Milky Way from Vela to Carina	134		
2.4 The Milky Way from Crux to Norma	154		
2.5 The Milky Way from Scorpius to			
Scutum	164		
2.6 Milky Way Objects at High Galactic			
Latitude	185		

Acknowledgements

First of all, we would like to thank all our colleagues who have made original images from La Silla available for reproduction in this book. They are identified in the List of Plate Data on page 263.

In addition, we gratefully acknowledge friendly support by the following astronomers in the form of texts, clarifying discussions, hints, etc.: M. Cullum, P. Grosbøl, S. Jörsäter, A.F.M. Moorwood, S. D'Odorico, H. Pedersen, B. Reipurth, H.-E. Schuster, P. Shaver, P. Stättmayer and M. Tarenghi. Thanks are also due to the Swedish team and P. Corbern at the Roque de los Muchachos Observatory, and Optronics Inc. (Plate 34).

We are particularly grateful for technical support by B. Dumoulin (photography), S. Dunlop (language editing), C. Jauch (drawings), H. Nielsen (typing), K. Kjær (proofreading), J. Québatte (photofinishing), E. Völk (typing), and H. Zodet (photography).

Finally, we are indebted to the Director General of ESO, Professor L. Woltjer, who suggested the compilation of this book and gave continuous encouragement during its preparation.

S. Laustsen · C. Madsen · R.M. West

Introduction

If you ever fly from Europe to South America, the chances that the person in the seat next to you is an astronomer may be larger than you think. A little less than half of the world's 6000 professional astronomers live in Europe and many of them regularly travel to the South. The goal of their journey lies in the dry Atacama desert, more than 600 km north of Santiago de Chile, under the splendid southern sky. Here they stay at the ESO La Silla Observatory, days or months at a time, scrutinizing the Universe with the most powerful astronomical instruments available.

The creation of the European Southern Observatory in 1962 has had a profound impact upon European astronomy. With the support of 8 member countries, it has stimulated collaboration among astronomers in Europe and abroad, and has undertaken several major projects advancing astronomical science and technology. Many discoveries, and significant progress in various astronomical fields, have been achieved at ESO. Astronomy may be one of the oldest sciences, but in many respects it is also one of the most modern. Gone are the days when the astronomer gazed through his telescope and told the world about his visual impressions. High technology has taken over, so that the maximum amount of information can be obtained during the precious observing time. In order to penetrate deeper into the mysteries of the Universe, the modern astronomer must work efficiently and with extremely sophisticated instruments.

The outcome of all these efforts can be found in professional journals and occasionally in the media, whenever a new, exciting discovery is made. The overall picture becomes available much later to the public and, due to the high degree of specialization, also to many of the professional astronomers.

This book does not attempt to evaluate in detail the front-line research that is done at La Silla, nor does it claim to give an evenly balanced account of modern astronomy. The present approach is different, not to say unusual. The idea has been to look over the shoulders of the astronomers and to select some of the impressive images of astronomical objects that have been obtained during the past 10 years at the ESO observatory. To explain briefly why these pictures are interesting, and to remind ourselves – not the least the professional astronomers – about the extraordinary beauty of the southern sky. Our aim is to describe the multitude of phenomena that we witness in the Milky Way and in other galaxies, and thereby to give a kaleidoscopic view of modern astronomical research.

Many of the illustrations in this book are based on photographs, but others have been obtained with modern detectors. Photography and astronomy have always been close companions and they have had a profound impact on each other. The very term “photography” was first introduced by the English astronomer John Herschel and there are numerous examples of how the repeated demands by astronomers for better and faster emulsions have stimulated photochemical research and led to the availability

of new and better photographic products on the amateur market. Likewise, the need to observe fainter and fainter objects has challenged the ingenuity of engineers in the fields of semiconductors, optics and electronics, and has also substantially contributed to the development of efficient image-processing software. Indeed, many of the innovations that have been made at ESO in these fields have been taken over in other disciplines and by European industry.

This book is a picture book and is meant to be used as such. Why not first have a look at the two hundred Plates of southern celestial objects and fields? Enjoy the beauty of these images, many of which have not been included before in a popular book. The reader who wants to know more will find the details in the text and the Figures. Note also the “Guide to this Book”, the Glossary, the List of Plate Data and the Indexes which contain much supplementary information. It is hoped that the complete documentation will render this book useful, not only to the interested layman, but also to the dedicated amateur astronomer and perhaps even to our professional colleagues.

A Guide to this Book

The photographs in this book can be enjoyed without knowledge of their provenance, but readers who want to know more will find detailed documentation in the *List of Plate Data* on page 263. A *Glossary* (page 257 ff.) explains many of the astronomical terms in the text. Individual objects can be found easily with the help of the *Indexes* (page 271 ff.).

In what follows, further information is given about some basic features of this book and the pictures therein.

THE PHOTOGRAPHS

With very few exceptions, all illustrations in Chapters 1–3 are reproductions of original exposures that were made with telescopes at the ESO La Silla Observatory. Most of them were obtained photographically, but some were made with modern detectors. Further explanation about CCD's is given on page 242.

Many of the pictures are reproduced in the normal way as *positive* photos with white stars on a black sky, but some are shown as *negative* photos, with black stars on a white sky. The “negative” presentation is quite common in astronomy, because the human eye is best able to discern fine differences in density against a relatively bright background. Faint celestial objects often come out better in a negative print.

Some of the *colour* pictures were originally made on colour film. Others are regenerated colour images, which were made by superimposing black-and-white images obtained in different

spectral bands. This method is superior to using colour film in that it better reproduces the “true” colours of astronomical objects. Some illustrations are computer-enhanced, “*false-colour*” images, in order to better show particular details. The relevant information is given in the text.

Some of the images seen in the illustrations are not celestial but result from *optical reflection* in the telescope used. A typical effect is the “cross”, sometimes with a circular “halo” around brighter stars. It is caused by the spider that carries the secondary mirror or the plateholder. Very bright stars, even if they are outside the field of the photograph, may cause double or multiple reflections in the telescope optics with resulting “ghost” images. A typical example is seen in Plate 187. In some Schmidt pictures, the light from bright stars at the edge of the field is reflected from the plateholder and is seen as a diffuse, fan-shaped image, perpendicular to the edge.

ORIENTATION, SCALE AND POSITION

The *orientation* of almost all the celestial photos in this book is such that north is up and east is to the left. This principle has been strictly maintained, except in a few cases. For instance, it has no meaning for Plate 50, containing the celestial South Pole, and for Plate 122, containing both celestial poles. For the wide-angle Milky Way photos, Plates 124, 132, 133, 149, 150, 157 and 158, it would have led to serious

lay-out problems to maintain the principle. For these Plates the related Figures show the orientation. Finally, in a few cases (Plates 1, 139, 178, 199, 200, 202 and 203) it was more convenient to choose a different orientation, which is indicated for each Plate.

The List of Plate Data (p. 263) gives additional information about each photo. The *image scale* is indicated as degrees (°), arcminutes (′) or arcseconds (″) per centimetre. A full circle measures 360°; 1° = 60′ = 3600″; 1′ = 60″. The *angular distance*, that is the separation in the sky between two objects can be calculated by measuring their distance on the photo in centimetres, and then multiplying this figure with the image scale given in the Table.

The celestial *positions* of the photos are also given in the Table of Plate Data. Astronomers use a coordinate system in the sky that is very similar to geographical longitude and latitude on the surface of the Earth. In this so-called *equatorial system*, *Right Ascension* (R.A.) corresponds to longitude and *Declination* (Decl.) to latitude. R.A. increases towards the east from 0 h to 24 h (0 h–24 h), and Decl. from the celestial South Pole at –90°, over the equator at 0° to the North Pole at +90°. The zero-point (R.A. = 0 h; Decl. = 0°), also known as the “Vernal Equinox”, is the position in the sky of the Sun on March 21.

Another system of coordinates relates to our own Galaxy, and is called the *Galactic coordinate system*. *Galactic longitude and latitude* describe positions in the sky, relative to the plane of our Galaxy, that is to the band of the Milky Way (see also Plate 122 and the fold-out panorama).

They are both expressed in degrees, and the zero point (longitude = 0°; latitude = 0°) is the direction of the centre of the Milky Way Galaxy.

NAMES AND DESIGNATIONS

The brighter stars bear intriguing *names* like Betelgeuse, Canopus and Pollux. Many of them can be traced back to antiquity and relate to Greek or Roman mythology, and others are of Arabic origin. For instance, Betelgeuse is a corruption of the Arabic “yad al-jawza”, the hand of Orion. Canopus is a Greek proper name with Egyptian roots and Pollux is the latinized name of a character in Greek mythology, the twin of Castor. Quite a few of the non-stellar objects described in this book have descriptive names like the “Orion Nebula”, the “Antennae galaxies”, etc. See also Table 1 in the Index of Objects (p. 271).

From ancient times, the sky has been divided into *constellations*, that is groupings of bright stars that seem to form figures and symbols in the sky. Different cultures have divided the sky in different ways and a great variety of constellations are known in historical sources. The 89 constellations that are now in use were defined by the International Astronomical Union in 1923.

Bright stars are often referred to by the constellations to which they belong. For instance, the brightest star in the constellation of Centaurus is Alpha Centauri, and the second brightest is Beta Centauri. The short forms are α Cen and β Cen. This *nomenclature* was first introduced by the German astronomer Johann Bayer (1572–1625) who based his system on observations done by his contemporary Danish colleague, Tycho Brahe (1546–1601). In those pre-telescopic days, errors were made and β Ori (Rigel), not α Ori (Betelgeuse), as one would expect,

is the brightest star in Orion. The Greek alphabet is listed below.

In the early 18th century, the English astronomer John Flamsteed (1646–1719) gave consecutive numbers to stars in each constellation, ordered by R.A.; for instance, Betelgeuse was “58 Ori” in his system.

However, most astronomical objects do not carry names but only *designations* which originate in some catalogue, compiled by patient and persistent observers. The objects in this book have designations from the following astronomical catalogues (see also the Glossary):

M	Messier Catalogue (1771–1782)
NGC	New General Catalogue of Nebulae and Clusters of Stars (1888)
IC	First and Second Index Catalogue (1895, 1908)
HR	Bright Star Catalogue (4. Ed., 1982)
HD	Henry Draper Catalogue (1918–1924)
ESO	ESO/Uppsala Survey of the ESO(B) Atlas (1982)

Tables 2 and 3 of the Index of Objects contain all the objects mentioned in this book, ordered by Messier and NGC/IC numbers, respectively.

BRIGHTNESS, LUMINOSITY, MASS AND DISTANCE

The *apparent brightness* of an astronomical object is the brightness with which we see it in the sky. It is common to express the apparent brightness in *magnitudes*, a system which was first introduced by the Greek astronomer Hipparchos (died in 125 B.C.), but defined in modern terms in 1857 by the English astronomer Norman R. Pogson (1829–1891). According to this system, a star of 1st magnitude is $\sqrt[5]{100} \sim 2.512$ times brighter than a 2nd-magnitude star. A difference

of 5 magnitudes therefore corresponds to a difference in apparent brightness of exactly 100 times. We can also write 1st magnitude as 1^m, 2nd magnitude as 2^m, etc. Intermediate brightnesses are expressed with decimals, for instance 1^m.5. The brightest star in the sky, Sirius, has an apparent magnitude of –1.6. It is 7.6 magnitudes, or about 1100 times, brighter than the faintest stars that can be seen with the unaided eye, and which are of magnitude 6. The faintest objects that can be observed with large telescopes are of magnitudes 25–26.

A relatively faint object close to us may have the same apparent brightness as a luminous object further away. An important, but difficult aspect of astronomical research is to determine the *luminosity* of an object, that is the total amount of radiation it emits per unit of time. It is common to compare other stars to the nearest one, our Sun. A frequently used astronomical unit is therefore a *Solar Luminosity*, which is the amount of energy radiated by the Sun per second. The luminosity of a star depends on its temperature and its radius. Another astronomical unit is a *Solar Mass*. The heaviest known stars have masses of about 100 solar masses.

In astronomy, earthly units of measurement often turn out to be inconvenient. For instance, *distances* are usually expressed in *Light-years* or *Astronomical Units*. One light-year is the distance which is travelled in one year by light at a speed of 300 000 km/sec. A light-year may be divided into light-days or light-minutes. On this scale, for example, the mean distance between the Sun and the Earth is 8.2 light-minutes. This distance, 150 million km, is also referred to as one astronomical unit, which is mainly used in descriptions of the Solar System.

It is difficult to determine distances outside the Earth, and most astronomical distance measurements are not very accurate, at least by com-

mon standards. The distances to the nearest stars, around 4 light-years, are known with an accuracy of 1–2%, but with increasing distance, the achievable precision rapidly deteriorates. Methods of distance determination are mentioned in connection with Plates 6, 37 and 124.

The apparent brightness of an object depends on its luminosity and distance. It decreases with the *square of the distance*, so that if we were to move an object to twice its present distance, its apparent brightness would become four times less; at three times the distance, it would be nine times less, etc. In other words, if we know the apparent brightness and the luminosity of an object, we can calculate its distance; if we know the apparent brightness and the distance, we can calculate the luminosity. Note, however, that this is only true if there is no obscuring material between us and the object.

TEMPERATURE AND SPECTRUM

In daily life, we measure *temperatures* in °C or °F. In astronomy, temperatures are expressed in degrees Kelvin (K), that is degrees above the absolute zero at -273°C . The stars have different surface temperatures. A common stellar classification system corresponds to the temperature scale: O-stars are the hottest (100 000 K), then follow the B-stars, the A-stars and the F-stars. The Sun (5800 K) is of type G, the K-stars are cooler and the coolest are of type M (3000 K).

All material bodies, stars and nebulae included, emit electromagnetic radiation. Depending on the wavelength, this radiation is known by different names, as *radio*, *microwave*, *infrared*, *optical* or visual, *ultraviolet*, *X-ray* and *γ -ray*, when we move through the spectrum from the longest to the shortest wavelengths. Since a shorter wavelength corresponds to more energetic radiation, γ -rays are more energetic than X-rays, and ultraviolet radiation is more energetic than infrared radiation. Hot objects are more energetic than cold ones and therefore radiate more energy in the short-wavelength region. For example, a star that is hotter than the Sun emits more ultraviolet radiation than does the Sun. In the visual region, blue light has a shorter wavelength than green light, and green light in turn has a shorter wavelength than red light.

Atoms radiate at specific wavelengths (*spectral lines*). The observation of spectral lines in the light of a star therefore indicates the presence of the corresponding atoms in the outer layers of that star. One of the most common spectral lines in the light of interstellar nebulae is the so-called “ H_α ”-line, which is emitted by hydrogen atoms in the red region of the spectrum with a wavelength of 6563 Å.

When an atom loses one or more electrons, it is said to become *ionized*. Regions in space with much ionized hydrogen (“H II regions”) are seen as “emission nebulae”, which emit strongly in the spectral lines of various ions and atoms, including the H_α -line. When the temperature is high enough, oxygen atoms may lose one electron and emit strongly in blue light. At even higher temperatures, two electrons are lost from each oxygen atom and the oxygen ions now emit in two green spectral lines. This book contains many examples of nebulae that show these colours.

ASTRONOMICAL UNITS

1 Astronomical Unit	$= 1.496 \times 10^8 \text{ km}$
1 Light-year	$= 9.461 \times 10^{12} \text{ km}$
1 Ångström (Å)	$= 10^{-10} \text{ m}$
1 Solar Luminosity	$= 3.9 \times 10^{26} \text{ Watt}$
1 Solar Mass	$= 1.989 \times 10^{30} \text{ kg}$

GREEK ALPHABET

$A\alpha$	Alpha	$N\nu$	Nu
$B\beta$	Beta	$\Xi\xi$	Xi
$\Gamma\gamma$	Gamma	Oo	Omicron
$\Delta\delta$	Delta	$\Pi\pi$	Pi
$E\varepsilon$	Epsilon	$P\rho$	Rho
$Z\zeta$	Zeta	$\Sigma\sigma$	Sigma
$H\eta$	Eta	$T\tau$	Tau
$\Theta\theta$	Theta	$Y\nu$	Upsilon
$I\iota$	Iota	$\Phi\phi$	Phi
$K\kappa$	Kappa	$X\chi$	Chi
$\Lambda\lambda$	Lambda	$\Psi\psi$	Psi
$M\mu$	Mu	$\Omega\omega$	Omega

1 The Universe and its Galaxies



1 The Large Magellanic Cloud is the nearest neighbouring galaxy in space, some 180000 light-years away.

The Universe is like a desert. It is a huge bubble of almost empty space. Imagine a cubic kilometre of the Universe at a point of average density. The amount of matter in such a cube is so small that it would weigh less than one of the tiny dust particles that are revealed on a surface of polished mahogany by a beam of sunlight.

Fortunately, we find oases in the desert. These are the deep-sky islands called galaxies, each of which consists of thousands of millions of stars and large nebulae of gas and dust. Using the unaided eye we are limited to the glimpse of only one such object in the northern sky, the great Andromeda Galaxy. Observers of the southern sky, however, may enjoy the much more impressive view of the two Magellanic Clouds, galaxies that are our nearest neighbours in the Universe.

A closer examination of galaxies requires the use of telescopes, and by exposing photographic plates through telescopes we are able to portray numerous galaxies. Photos of relatively nearby galaxies show great detail, while the images of distant ones only reveal their overall properties, such as size and shape. Thanks to greatly improved techniques, modern large telescopes are able to depict in greater or lesser detail hundreds of millions of galaxies in the Universe.

Among all the galaxies, among all the oases in the Universe, there is one which attracts our particular interest. This is the one in which we live, and which we call the *Milky Way Galaxy*. It appears different from all others because we see it from our special location, inside its confines. We observe a large number of its stars, some of which are relatively nearby and therefore appear well separated and distributed over the whole sky. Innumerable others are far away in the disk of our Galaxy and their combined light forms a luminous band along a great circle in the sky. Since ancient times this band has been called the Milky Way. We shall return to this, but let us first have a closer look at some of the other galaxies.

1.1 *A Look at Fornax*

Fornax is the Latin word for furnace, and is the name of a constellation in the southern sky. Most names of constellations go back to antiquity, and today they are still very useful for orientation on the celestial sphere.

Fornax will be our starting point because it contains the Fornax cluster of galaxies, the nearest dense cluster in the southern sky, as well as extended areas where nearby galaxies are scarce. The emptiness and the richness of the Universe are equally well illustrated in Fornax.

2 The emptiness of the Universe is shown by this deep Schmidt-telescope exposure of a field in Fornax. By “deep” we mean that the photo shows faint objects, some of which are far out in space. The field size of around 10 square degrees is 50 times the area covered by the full Moon.

There is not a single bright galaxy here, and only a few faint ones are visible. Their distances have not yet been measured. Some may be small galaxies at moderate distances, while others undoubtedly are galaxies of normal size at great distances. It is obvious that the Universe is fairly empty in this direction. In this field, the total mass of galaxies within a distance of half a billion light-years is hardly more than the equivalent of a few normal galaxies.

All the stars visible are, naturally, foreground stars in the Milky Way Galaxy. Their distances range from a few tens, to a few thousand light-years only.



3 The Fornax cluster of galaxies. This is another deep Schmidt-telescope exposure in Fornax and a small part of the constellation of Eridanus (the River). The field is close to the one shown in Plate 2, and the field size and scale are the same. The difference between these fields is striking and demonstrates that galaxies have a pronounced tendency to form clusters. Most galaxies are in fact members of groups or clusters. This picture shows the impressive Fornax Cluster at a distance of 60 million light-years.

The galaxies in the photo are of different types. Some are spirals, like NGC 1350, 1365, and 1437. Many are ellipticals, like NGC 1399, 1404, and 1427 – to mention the brighter ones only. At least one, NGC 1427A, is of the irregular type. The classification of galaxies into various types will be further described in Plate 8. The letters “NGC” refer to the “New General Catalogue” (of nebulae) which was published in 1887 by the Danish-British astronomer Johan L.E. Dreyer (1852–1926). It contains all “nebulae”, that is all objects with a non-stellar appearance that were known at that time.

It cannot be assumed a priori that all the galaxies in the field form part of the Fornax Cluster. For instance, NGC 1350 is not generally considered a member, whereas NGC 1365 probably is a member rather than a foreground gal-

axy. Most of the bright galaxies, however, certainly belong to the cluster, as do most of the fainter ones. Indeed, the Fornax Cluster contains a large number of dwarf elliptical galaxies. We shall now take a closer look at a few galaxies in the Fornax Cluster.

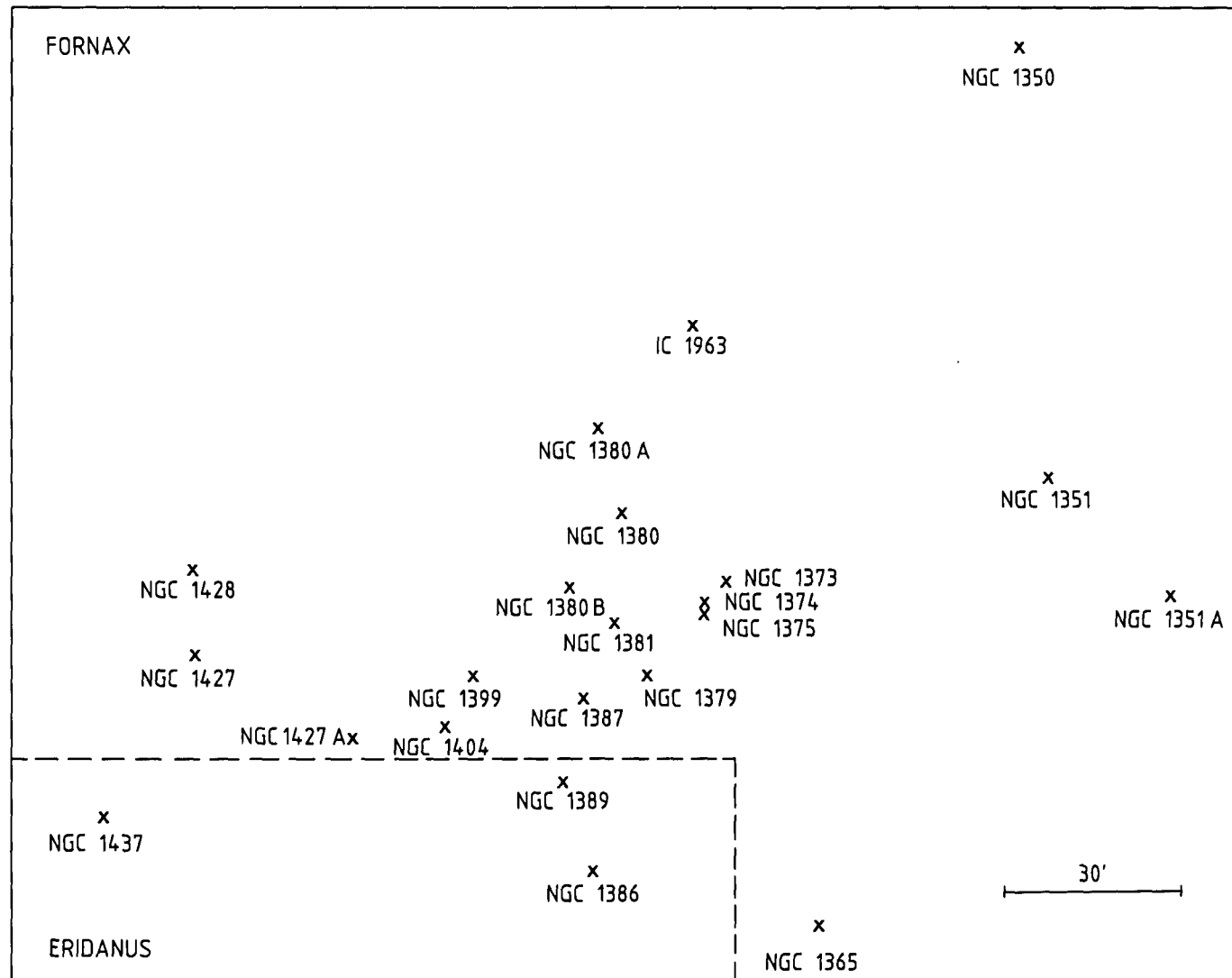



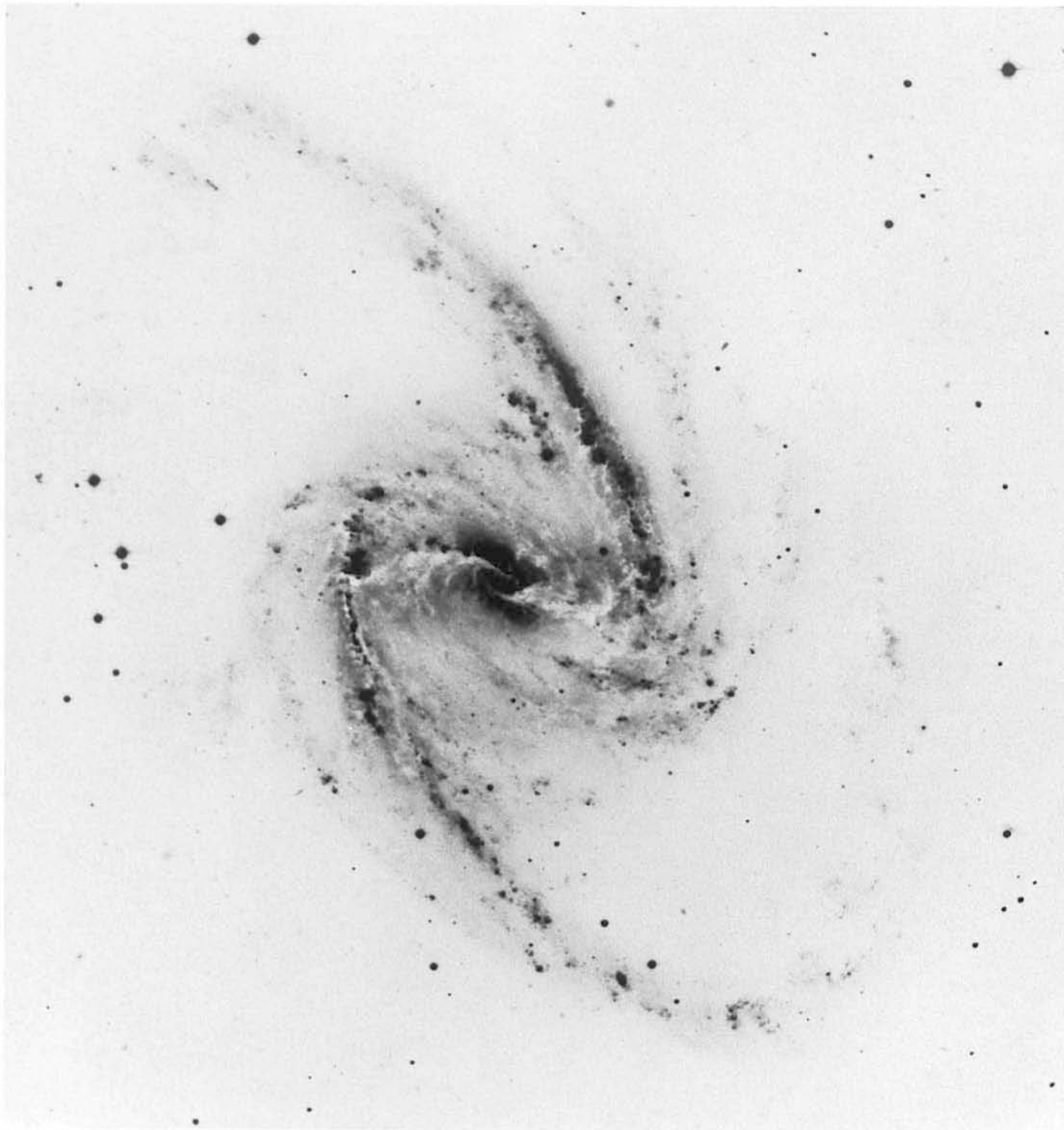

4 Assuming it is a member, *NGC 1365* is the largest and most impressive galaxy in the Fornax Cluster. It is in fact one of the largest spirals in the southern sky. More specifically, it is called a *barred* spiral galaxy. It has a “bar” crossing the central part, and from the ends of the bar two distinct and quite open, spiral arms branch off. The apparent geometry of the arms is a result of the orientation of the galaxy, relative to our line of sight. In fact, the disk of *NGC 1365* is inclined at 55 degrees to the tangential plane of the sky, and the north-west side of the disk is the one closest to us.

The spiral arms are delineated by a large number of bright spots, which are areas of luminous gas, known as H II regions. On the inner side of the arms and also along the bar we note some dark lanes. They are caused by dust clouds which absorb the light of the stars behind them.

NGC 1365 is one of the larger galaxies. It is more luminous than either the Milky Way Galaxy or the Andromeda Galaxy. It radiates as much energy as several hundred billion Suns.

5 This colour composite of *NGC 1365* was made by photographic combination of black-and-white Schmidt plates obtained in different spectral bands. It shows less detail than the 3.6-m telescope exposure (Plate 4). But the colours are instructive, because they show that the stellar content, also called the *stellar population*, is different in various parts of the galaxy. The yellow colour of the central area and of the bar shows that these parts are dominated by old, relatively cool stars, while the blue colour of the arms is caused by the radiation from a population of young, hot stars.



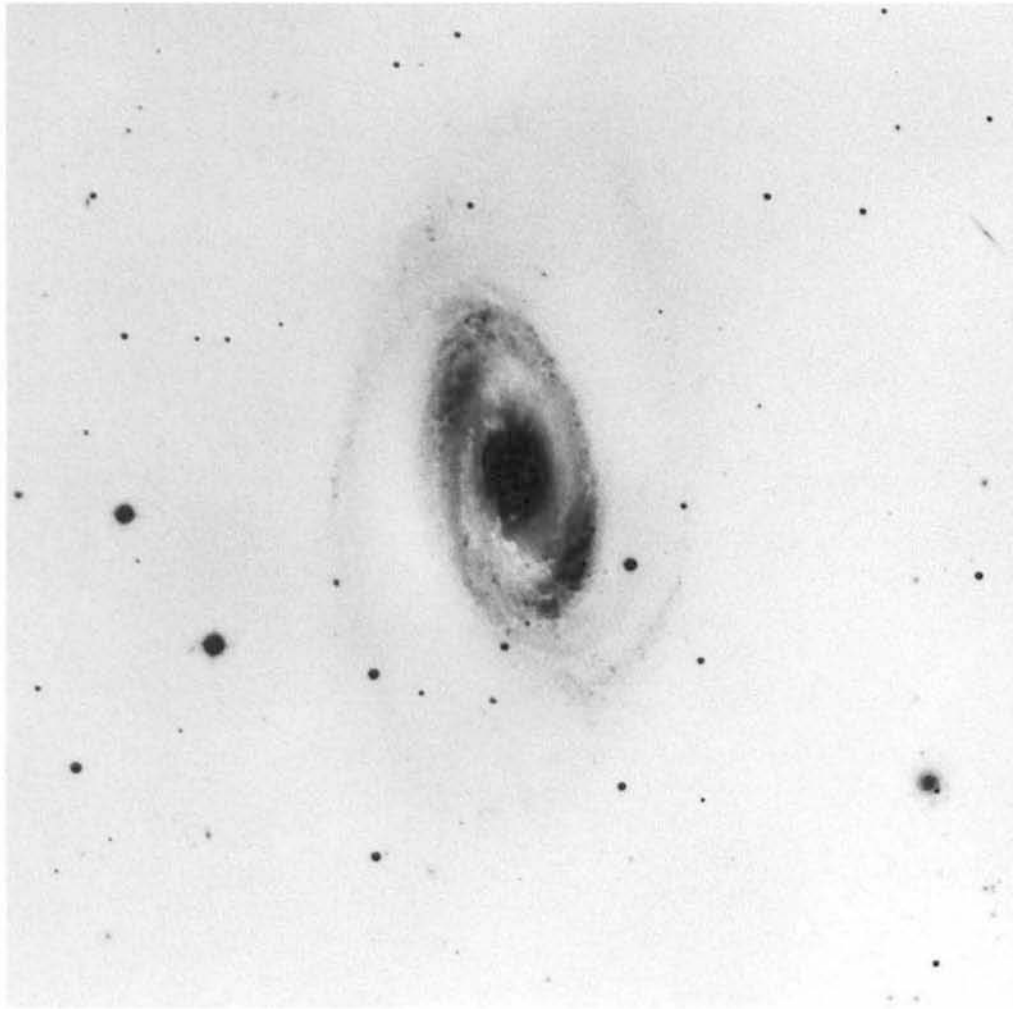

6 NGC 1350 is a spiral galaxy that is rather different from NGC 1365. It has a large central region, called the *nuclear bulge*, outside which there is an uneven ring structure. Two faint spiral arms arise in this ring. Due to the projection effect, the ring appears elliptical in shape. In reality it is circular and lies in the plane defined by the flat, spiral arms.

It is uncertain whether NGC 1350 is a member of the Fornax Cluster. Its position in the sky is rather far from the cluster's centre, and a determination of its distance seems to indi-

cate that it is somewhat farther away than the other galaxies in the Fornax Cluster.

In astronomy, the determination of distances is a matter of the greatest importance. In order to fix the position of a star or galaxy in space, we must know its direction and also its distance. In the case of nearby galaxies, in which we can see individual luminous stars, star clusters and other objects, we can make a comparison with similar objects in the solar neighbourhood. Suppose we know the distance to a star of a particular type, not too far away from the Sun. If we

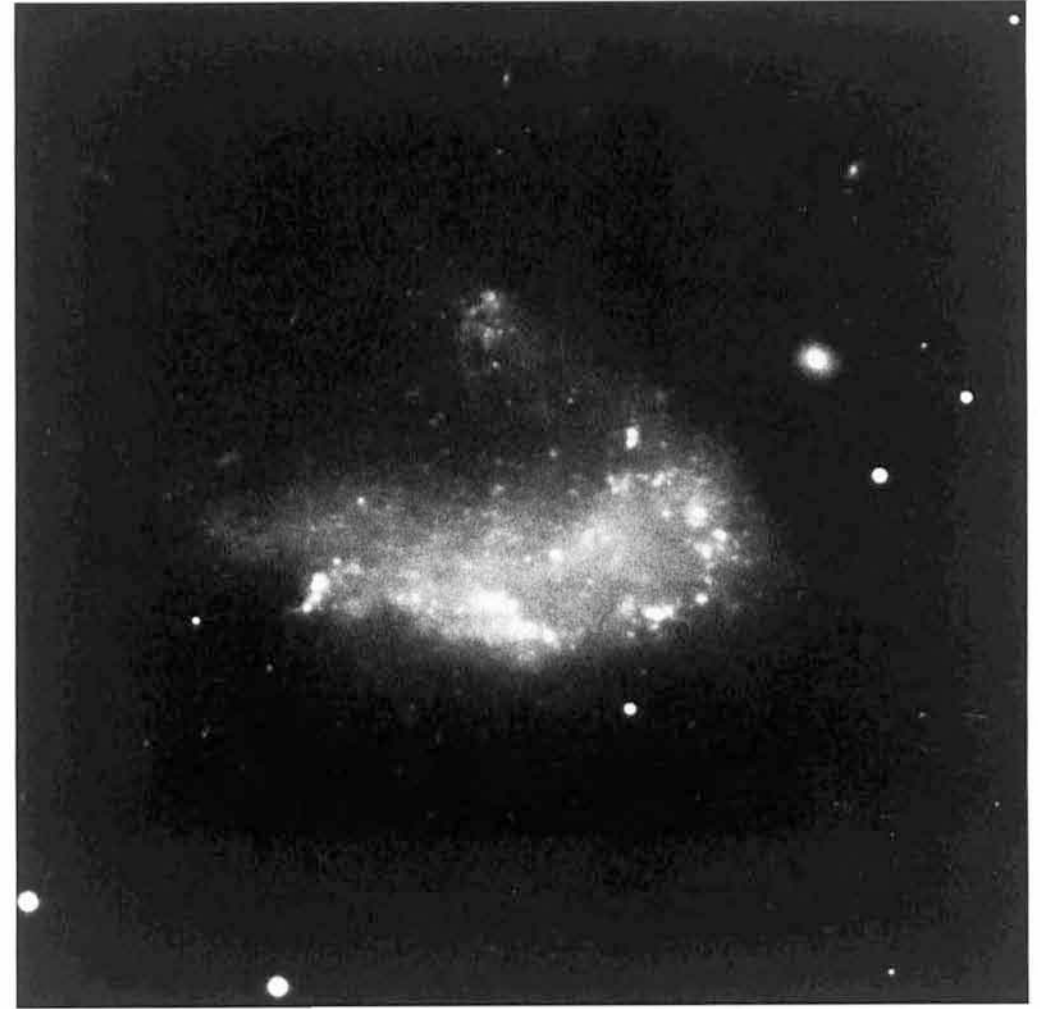

observe a star of the same type in a nearby galaxy, the difference in the apparent brightness of the two stars allows us to measure the distance of the galaxy. The brightness decreases with the square of the distance, and if the star in the galaxy is, say, 1000000 times fainter than the star in our neighbourhood, then it is 1000 times more distant. We then multiply the distance of the nearby star by 1000 and obtain the distance of the galaxy.

For more distant galaxies, in which we cannot see individual stars, this procedure does not

work, and we must use an indirect method. Due to the general expansion of the Universe, all galaxies are drifting away from each other. When viewed from any point in this expanding Universe, every galaxy is moving away along our line of sight. The more distant a galaxy, the higher the velocity with which it moves away. This velocity along the line of sight is called the *radial velocity*, and it can be determined from the measured shifts of lines in the spectrum of the galaxy. Since all galaxies (with just a few exceptions) are moving away from us, their spectral lines are shifted towards longer wavelengths or, in the optical region of the spectrum, towards the red. We therefore talk about *redshifts*.

The redshifts of galaxies can be measured, even for faint and distant ones. It is proportional to the radial velocity, which in turn is proportional to the distance. It is, however, a difficult matter to determine the ratio between these properties, the so-called *Hubble constant*. It has to be established by means of relatively nearby galaxies for which the distances can be found

by the method mentioned above. So far astronomers have not managed to determine a Hubble constant with which everyone can agree. In this book, a “rounded mean value” is used, expressed as 20 km/s per million light-years. This is to say that from a measured radial velocity of (for instance) 1000 km/s we deduce a distance of 50 million light-years. In the case of NGC 1350, the measured radial velocity is 1860 km/s, corresponding to a distance of 93 million light-years. It would therefore appear that it is situated behind the Fornax Cluster.

7 *NGC 1427 A* is a Fornax-Cluster member of the irregular type. It has no nucleus defining its centre, and it has a messy and irregular shape. It contains a large number of luminous gas clouds, which, at the western edge of the galaxy, form part of a ring.

8 *Hubble's “tuning-fork” sequence of galaxy types*

1.2 An Ordered Sequence of Galaxies

Order is required. Galaxies are ordered or classified according to their large-scale structure, also referred to as their “morphology”. The basic scheme of classification, still in use, goes back to the American astronomer Edwin Hubble (1889–1953), who in 1936 published a famous book “The Realm of the Nebulae” with his sequence of galaxy types. This was presented in a “tuning-fork” diagram. The tuning-fork is represented here by a sequence of galaxy photos selected from the *ESO Quick Blue Survey* of the southern sky. The elliptical galaxies E0-E7 make up the fork’s handle, while the normal spirals Sa-Sd and the barred spirals SBa-SBd make up the fork’s two prongs. S0 galaxies constitute a transition type between ellipticals and spirals, and the irregular-type galaxies Im and IBm form natural extensions to the normal and barred spirals, respectively.

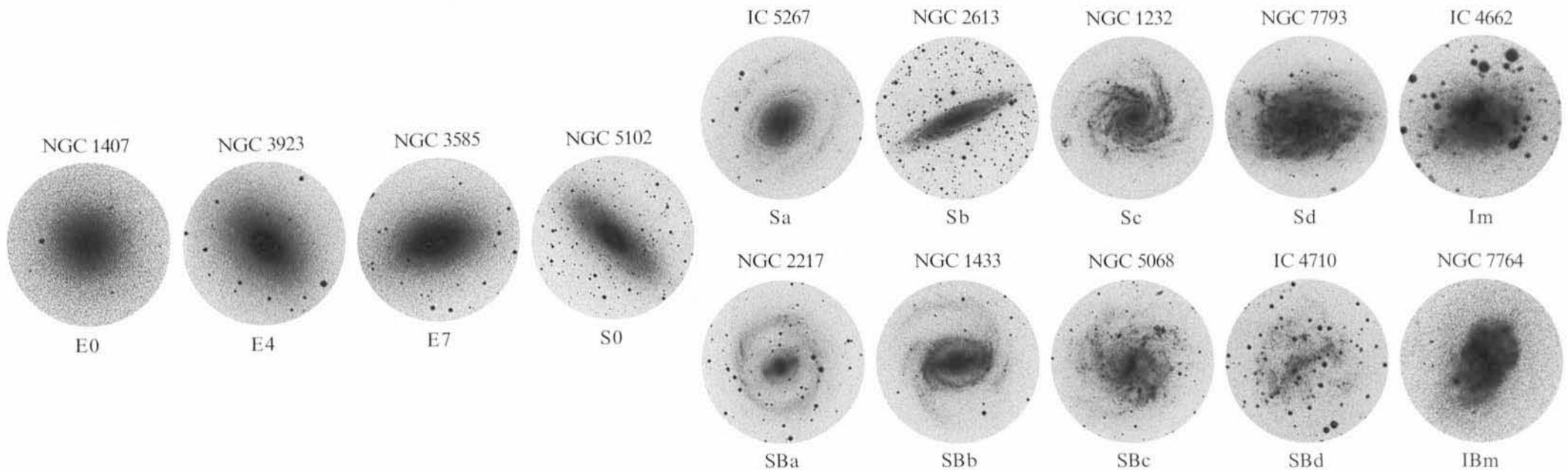

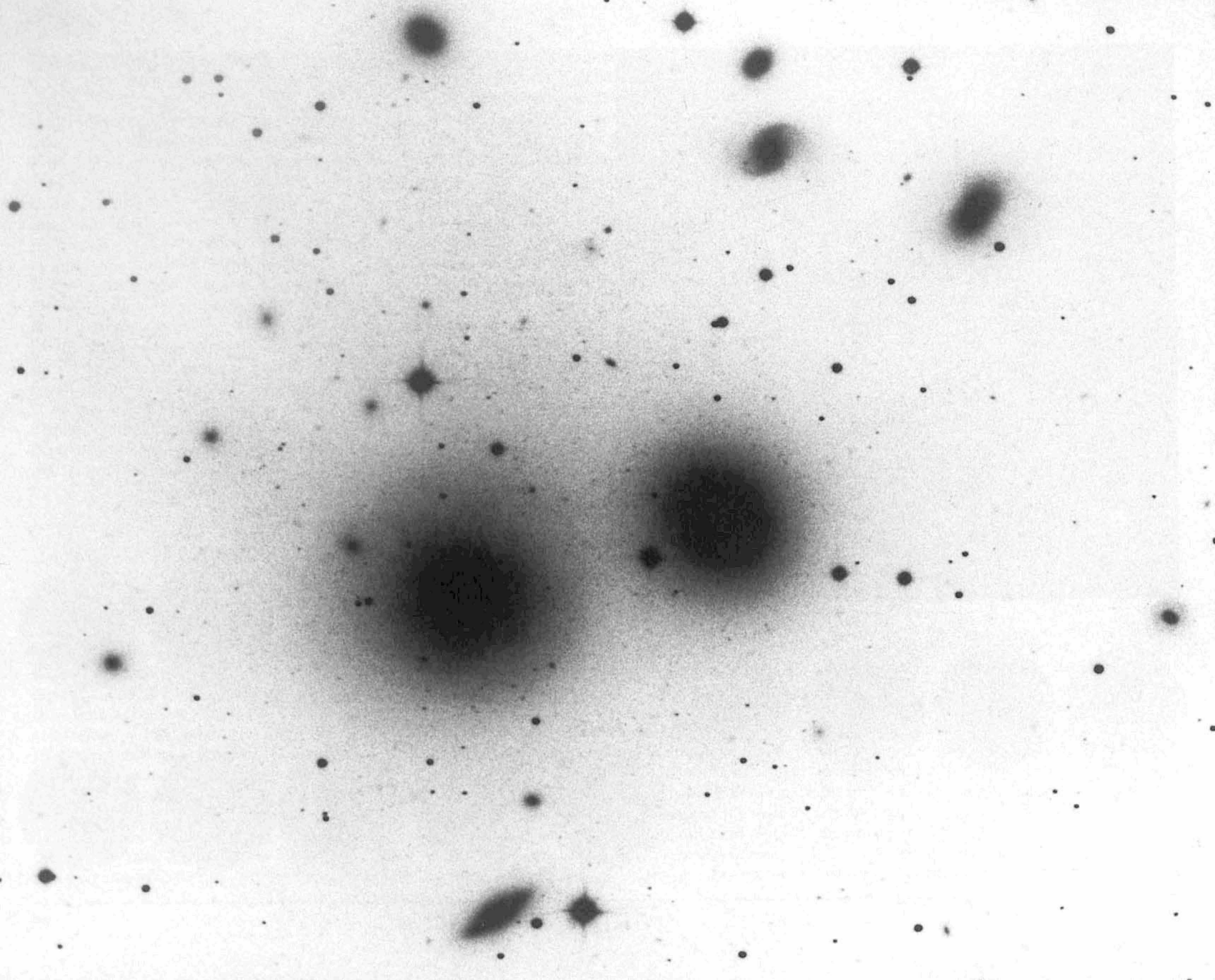

In astronomical terminology, the term "early type" is used for galaxies to the left in the sequence, and "late type" for galaxy types to the right. An Sc galaxy, say, is of a later type than an Sb galaxy. It should be noted, however, that such expressions bear no relation to age or development. It is generally believed that no evolution along the sequence is likely to occur.

The classification of galaxies can be a difficult problem. The objects lie at a wide range of distances, and the disks of S0 and spiral galaxies may have any possible inclination relative to the line of sight. Today thousands of galaxies have been classified, and new classification criteria in addition to those of Hubble have been introduced. His morphological classification scheme is quite adequate for nearly all galaxies. The remaining few per cent which do not fit into this scheme are called "peculiar" galaxies. They are among the most "interesting" objects in the sky.

ELLIPTICAL GALAXIES

The images of elliptical galaxies are perfectly symmetrical. Their apparent flatness or ellipticity is expressed by a figure from 0 to 7. An E0 elliptical galaxy appears circular, while E7 is the flattest class of ellipticals known. We should not forget that classification into classes E0 to E7 is only based on the apparent form. The real shape of a particular elliptical galaxy is very difficult to determine because the effects of projection are normally unknown, but generally they are assumed to be rotationally symmetrical ellipsoids.

The Fornax Cluster, Plate 3, contains several ellipticals. NGC 1374 and 1379 are E0 galaxies, NGC 1399 is an E1, NGC 1404 is an E2, and NGC 1427 is an E5 galaxy.

9 In the constellation of Hydra we find a fine cluster called Hydra I, of which the central part is portrayed here (a more extended part is shown in Plate 95). The field is dominated by the giant, twin galaxies *NGC 3309* (right) and *NGC 3311* (left). The cluster is at a distance of nearly 180 million light-years, and its brightest galaxy, NGC 3309, shines with the power of one hundred billion Suns.

NGC 3309 is a typical E1 galaxy. It is among the largest of its class. NGC 3311 looks like an elliptical galaxy and could be classified as such. In reality, however, it belongs to a class of objects with the prosaic name of "cD galaxies". Galaxies of this type have a light distribution over their surface that is different from that of normal elliptical galaxies. It is relatively less bright near the centre, but brighter in the outer areas. The extended brightness is caused by a huge halo with a thin population of faint stars. On long exposures that show the halo, like this one, NGC 3311 appears brighter than NGC 3309. Conversely, NGC 3311 is the fainter one on short exposures that do not show the halo.

10 In this short exposure, NGC 3311 appears much fainter than NGC 3309. This illustrates the difference between the two galaxies as far as the concentration of stars towards their centres is concerned. An interesting feature of NGC 3311 is the dusty absorption lane at its very centre, and also the small, bright spot of gas at the eastern edge of that lane. cD galaxies and ellipticals contain very little gas and dust. Features like these are very rare phenomena in such objects.



The central component of S0 galaxies is similar to an elliptical galaxy. However, like spiral galaxies, around this central component they have a disk, but this is without any trace of spiral structure. The Fornax Cluster (Plate 3) is rich in S0 galaxies. Examples are NGC 1351, 1380, 1381, 1387, and 1389.

11 This S0 galaxy, *NGC 6861*, has been imaged with a *CCD detector* through three different optical filters; the three exposures have been combined by computer to produce a colour picture. The CCD detector, which is built into a special camera, is based on advanced electronic and optical technology similar to that used in some modern TV cameras. The image is recorded as a number of picture elements (pixels), which are often seen as small squares.

The central part of the galaxy is overexposed in all three colours and thus comes out white. The image does not reveal much structure, but the presence of a disk is clearly indicated by the lane of absorbing material on the near side of the galaxy. The absorbing material on the rear side is hidden behind the bright central component.

12 *NGC 5128* is a peculiar galaxy, which consists, in an unusual way, of two quite different components. The main component can be classified as an elliptical, or an S0 galaxy, which is the reason for presenting this galaxy here. But this component is surrounded by a strange dark band of absorption. It is caused by the secondary component which has the form of a disk of stars, gas and dust, with a composition similar to that of the disk of a spiral galaxy.

The strongest, celestial radio source in the constellation of Centaurus, Centaurus A, is associated with *NGC 5128*. It is a quadruple radio source in which the main emission comes from two large areas several degrees apart, one on each side of the galaxy. In addition, there is weaker emission from two smaller sources, also on either side, but closer to the galaxy. All four sources lie close to a straight line through the centre of the galaxy, and at right angles to the absorption band.

A number of suggestions about how nature could produce a peculiar galaxy like *NGC 5128* have been put forward over the years. In one early scenario, a dramatic collision between an elliptical and a spiral galaxy was considered. Later, when the radio source was resolved into the four components just mentioned, the possibility of a series of explosions was studied. However, it appeared impossible to find a mechanism that could explain both the radio lobes and the girdle of dust. Most recently, the model involving a collision is again gaining ground. It has now been realized that so-called “slow” collisions between two galaxies, during which a merger takes place, play a major role in the production of peculiar galaxies (see Section 1.7), and perhaps also certain types of normal galaxies.



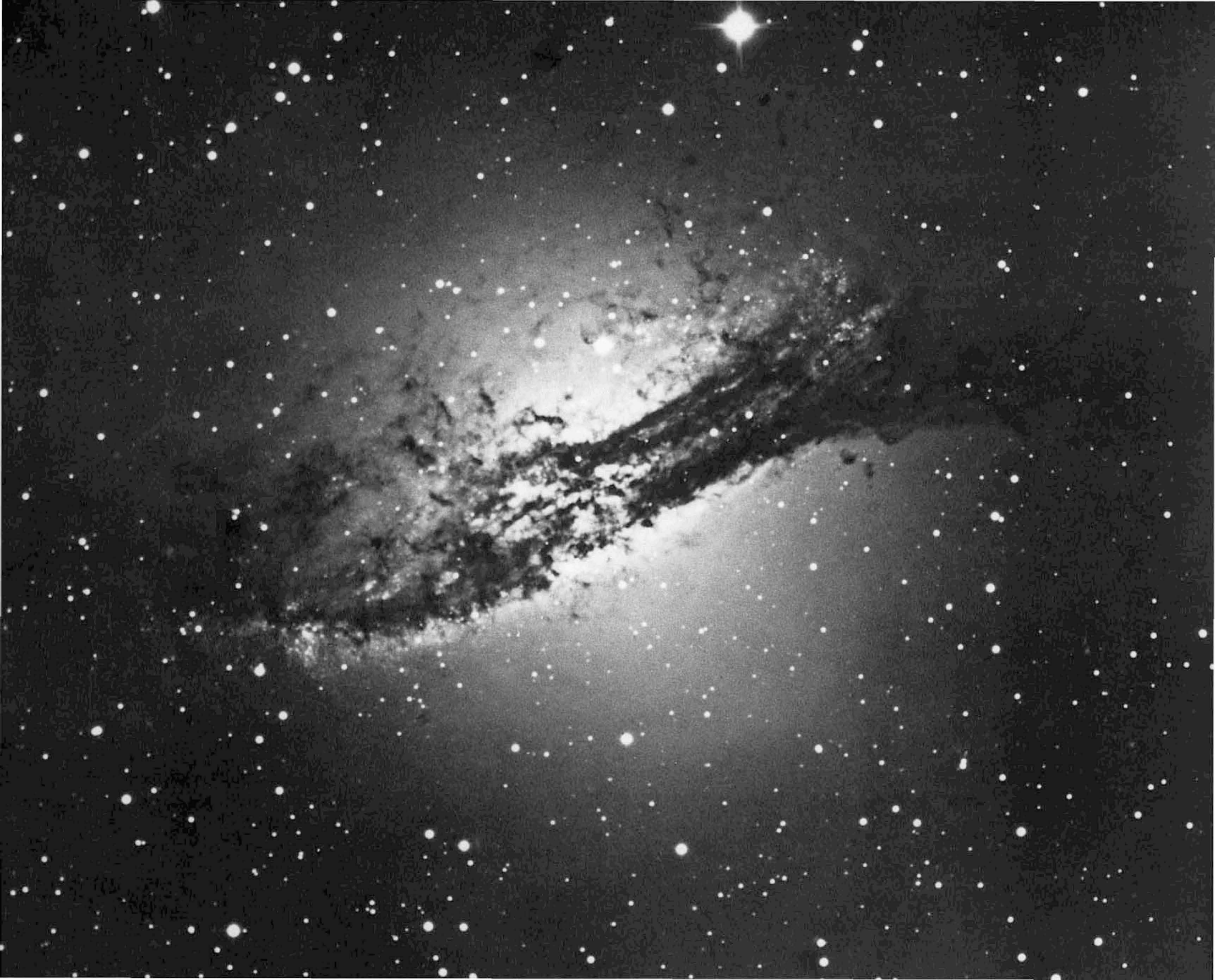



13 An important astronomical event in the year 1986 was the appearance of a 12th-magnitude supernova in NGC 5128. It was discovered on May 3 by an Australian amateur astronomer, and was given the official designation 1986G by the International Astronomical Union. It appeared as a “new star” southeast of the centre of NGC 5128, and almost in the middle of the dust band, as seen on this Plate, which has the same scale as Plate 12. No supernovae have ever

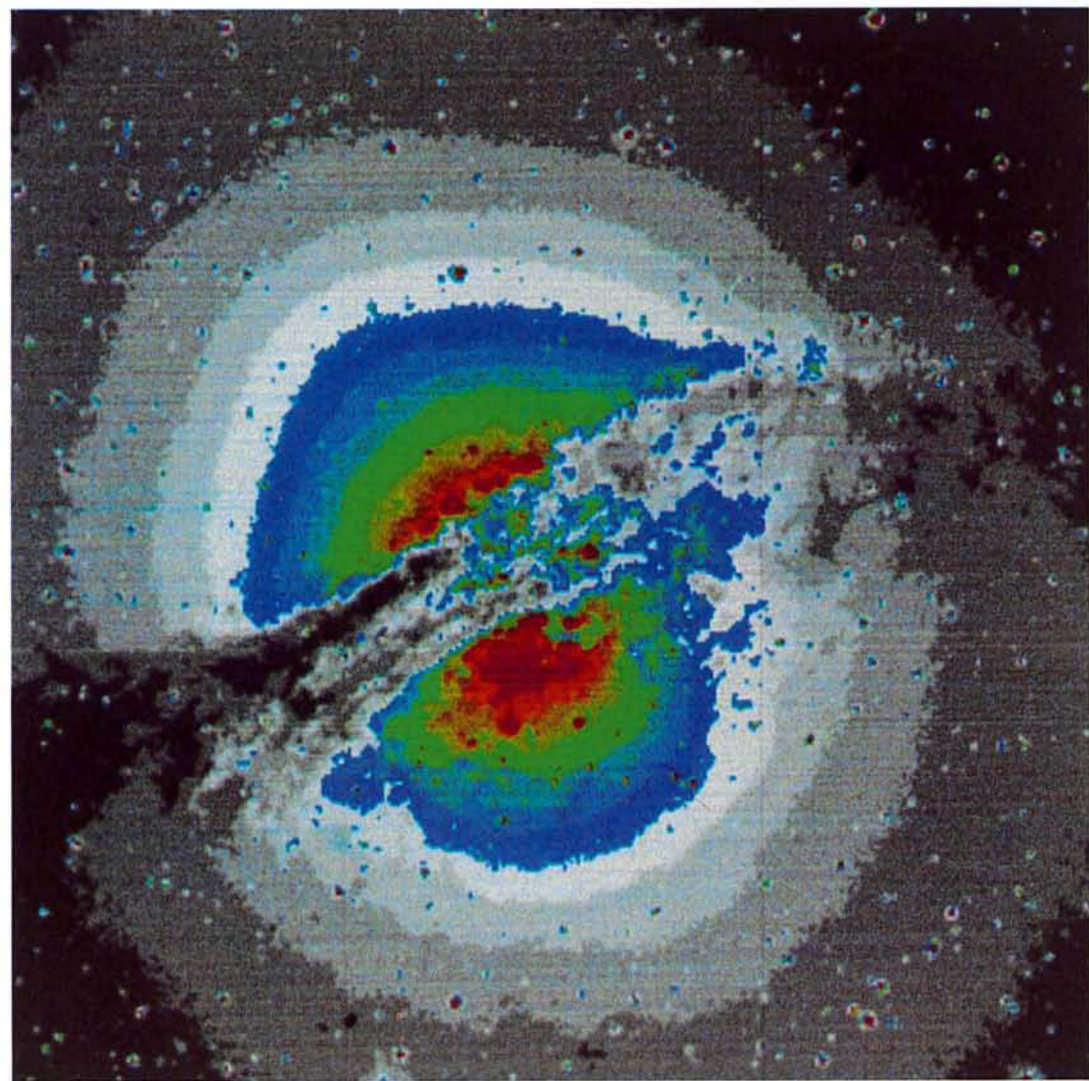

been detected in this galaxy before. It was a most welcome event for astronomers, because bright supernovae are rare, and also because of the peculiar nature of NGC 5128.

Supernovae are exploding stars; see also Plates 52–54 and 138–139. News about supernova 1986G was quickly transmitted to observatories all over the world by the International Astronomical Union’s Telegram Bureau. At the ESO La Silla Observatory, the supernova was

observed by a dozen astronomers, using six different telescopes during the first week after discovery. These observations, and the position near the middle of the dust band, show that the supernova is situated well inside NGC 5128. Its light is considerably dimmed by the obscuring dust. Had it been situated in an unobscured region, its apparent magnitude would have been about 7.5, and it would have been the second brightest supernova observed this century.

The distance to NGC 5128 is uncertain, but the observations of supernova 1986G seem to indicate 7 to 10 million light-years.

Note the difference between Plates 12 and 13. The latter was obtained with a 40-cm refractor and shows less detail than the former, which was taken with the ESO 3.6-m telescope.

14 This is a computer-processed, false-colour image of NGC 5128. The colours show contours of equal intensity (isophotes). It is seen more clearly here that the central component is elongated in the direction perpendicular to the absorption band.

15 This long-exposure Schmidt photo of NGC 5128 was photographically enhanced to bring out the very faint halo of the galaxy. Note the difference in scale between this picture and Plate 12. If this image were shown on the same scale as Plate 12, then the diameter of the galaxy would over half a metre. The picture also shows why the main component is classified as an S0 galaxy. Note too that a weak shadow of the absorbing band is visible, showing that the secondary component is also of considerable size.

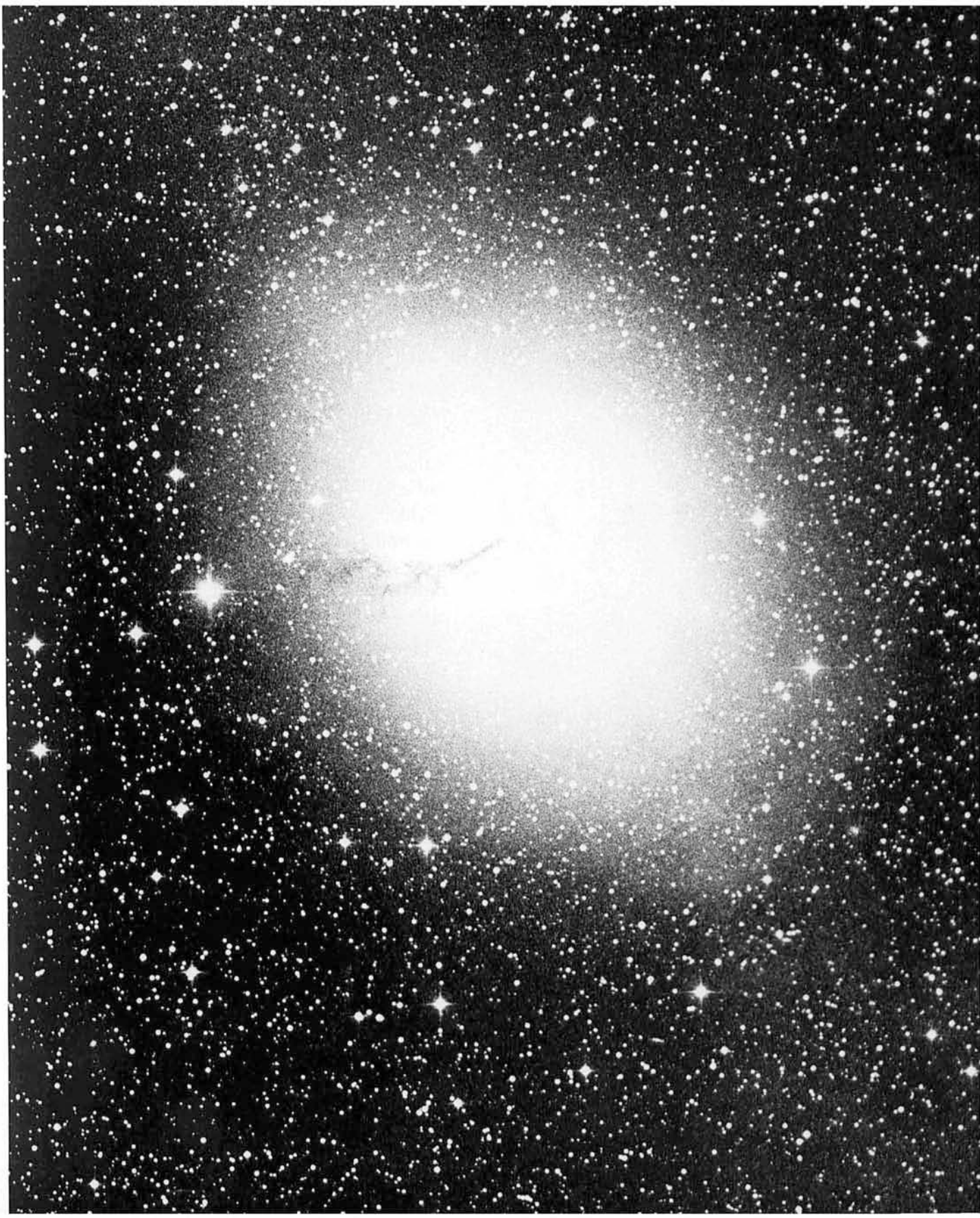

SPIRAL GALAXIES

We will first look at normal spiral galaxies, that is those without bars, of type Sa–Sd. The images of normal spirals generally show two main components, the nuclear bulge and the disk which contains the spiral structure. Very deep exposures may also show a third component, the halo.

16 If a beauty contest were held among galaxies in the southern sky, NGC 4594 (M 104) would be a serious candidate for the title. Incidentally, it is only 11 degrees south of the celestial equator, and it can be observed from all the world's major observatories. It has been observed many times, and been given various names. It was included as No. 104 in Messier's catalogue (see text to Plate 47) and, most appropriately, Spanish- and English-speaking people call it the *Sombrero* galaxy – the hat galaxy. It is at a distance of 44 million light-years.

This galaxy has a huge nuclear bulge, which contains innumerable, old, red stars. While the white colour at the centre is due to overexposure, the red colour in the outer part of the nuclear bulge is clearly seen. The three ingredients of the disk, namely stars, dust and gas, are also visible. A substantial fraction of the stars are hot and young, and they are the source of blue light in the disk. Part of the gas is ionized by radiation from the hottest, blue stars, and is visible as red patches in the disk. The dust clouds reveal their presence as a dark band that absorbs the light of the nuclear bulge behind it.

In a picture like this it is seen how the dust is confined to a very thin disk. The accumulation of the dust in a disk is a result of the rotation of the galaxy, and the disk is located perpendicular to the axis of rotation. The Sombrero galaxy is a fast rotator. At the outer edge of the visible disk, which is 38 000 light-years from the centre, the speed of rotation around the centre is 340 km/s. This implies that material at the edge of the disk will need a span of 210 million years to make a full revolution around the centre.

A first determination of the rotation of the Sombrero galaxy was made as early as 1916. Since then a number of more accurate determinations have been made of its rotation curve, which is a curve showing the speed in the rotation as a function of the distance from the centre. In the case of the Sombrero galaxy the curve is rising out to the very edge of the disk, and this implies that much mass must be distributed far out in the galaxy. This, by the way, is in accordance with our visual impression of the galaxy, as one from which much light is coming from the outer areas. The mass of the galaxy within a distance of 38 000 light-years from the centre has been calculated to around 300 billion solar masses.

Around the Sombrero galaxy we see a considerable number of diffuse spots. Most of these are globular clusters similar in composition and size to the ones found in our own Galaxy (Section 2.6).



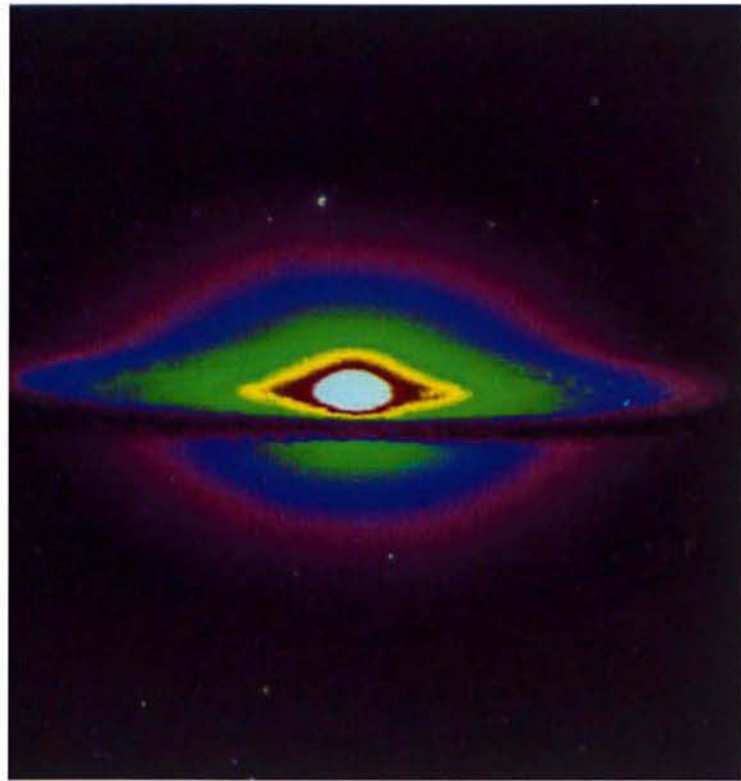

17 This computer-generated image shows the intensity contours of the Sombrero galaxy. Although the galaxy is seen nearly edge on it is not appearing flat at all, which is due to the exceptionally large central component of ellipsoidal shape.

18 In a one-minute exposure of the Sombrero galaxy, its central area with the nucleus is clearly visible, but otherwise there is little structure. The inner part of the disk and the absorbing band can also be seen.

19 The halo of the Sombrero galaxy is very large. Here, a long-exposure, red-light Schmidt plate was scanned and computer-processed in order to reveal the very faint light of the enormous halo. And even this is certainly not the full extent. Continuing efforts to detect weaker and weaker light repeatedly revise our estimates of halo size upwards. There is also no definite answer to the question of the source of the halo light, but most probably it is caused by the integrated light of a large number of very faint stars.

About the mass of the halo we have no safe information, but in spite of huge halo sizes the mass is expected to be moderate. Generally this is not believed to be the place where the “missing mass” of the Universe will be found.

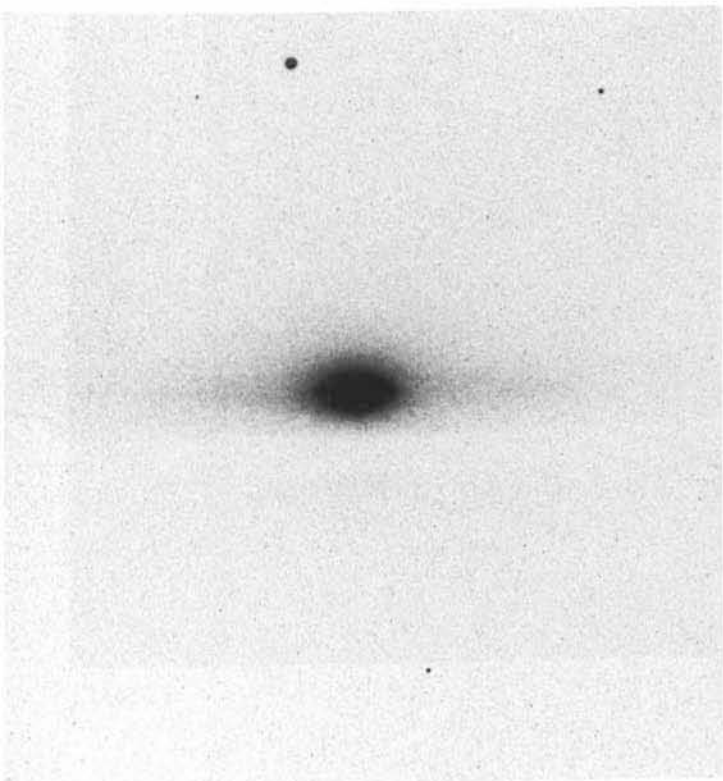

Plate 18

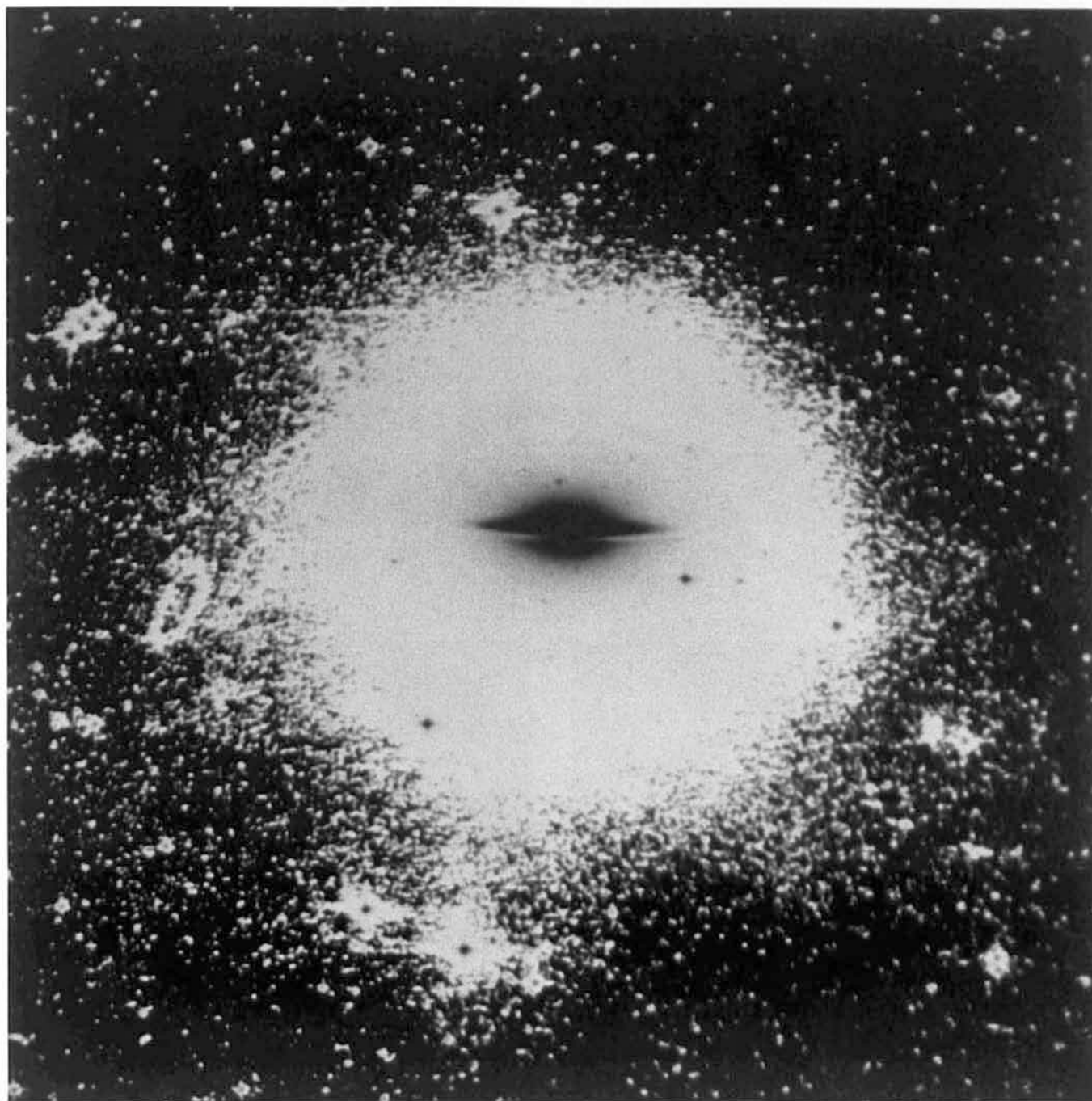

Plate 19

COLOUR PICTURES OF SPIRAL GALAXIES
TAKEN WITH A CCD CAMERA

As mentioned earlier, astronomy has recently profited greatly from a new type of imaging device, the Charge-Coupled Device, or CCD. See also page 242.

Images of a number of spiral galaxies were obtained with a CCD camera through three different optical filters, one transmitting in the blue spectral region, one in the red, and one in the infrared. The images were computer-processed and superimposed to produce colour pictures. The colours are not natural; this would have required blue, green, and red images. But the colours give a useful representation of the different components of galaxies and their different stellar populations. In general, blue colours correspond to young, hot stars and yellow-red colours to older, cool stars.

20 NGC 7742 is an Sa galaxy with a bright, yellowish bulge surrounded by a faint disk with tightly wound spiral arms.

21 NGC 6887 has an extremely small nuclear bulge. Its type is Sab, a transition type between Sa and Sb. The arms are tightly wound, yet clearly separated.

22 NGC 1068, also known as M77, is an Sb galaxy. The nuclear region is overexposed, but otherwise there is a clear difference between the yellow nuclear bulge and the blue spiral arms.

23 NGC 134 is an Sbc galaxy with a small nuclear bulge. There is an appreciable colour gradient from red near the centre to blue at the outside. The obscuration by dust in the disk is clearly visible since the galaxy is seen nearly edge-on.

24 NGC 7769 is an Sbc galaxy with multiple arms and a prominent, yellow bulge.

25 NGC 6814 is also an Sbc multiple-arm galaxy. It has a large, red, nuclear bulge, which is overexposed at the centre. Note that the red ring between the arms in the north-western part is not a celestial phenomenon. It is an instrumental defect, caused by a dust particle on the red filter.

26 NGC 7314 is a multiple-arm Sc galaxy with a clear difference between the red bulge and the blue disk.

27 NGC 157 is an Sc galaxy with a small bulge and blue arms. Some of the arms are very broad and they are intersected by absorption lanes.



Plate 20



Plate 24



Plate 21



Plate 22



Plate 23



Plate 25

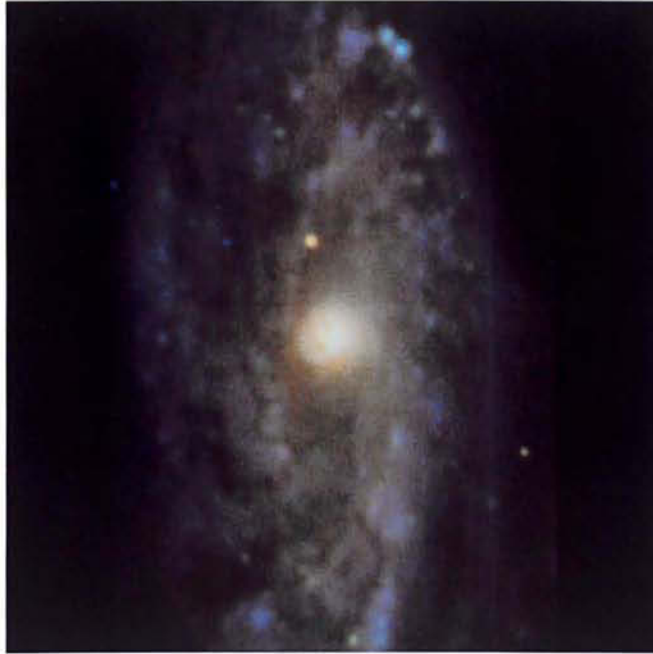
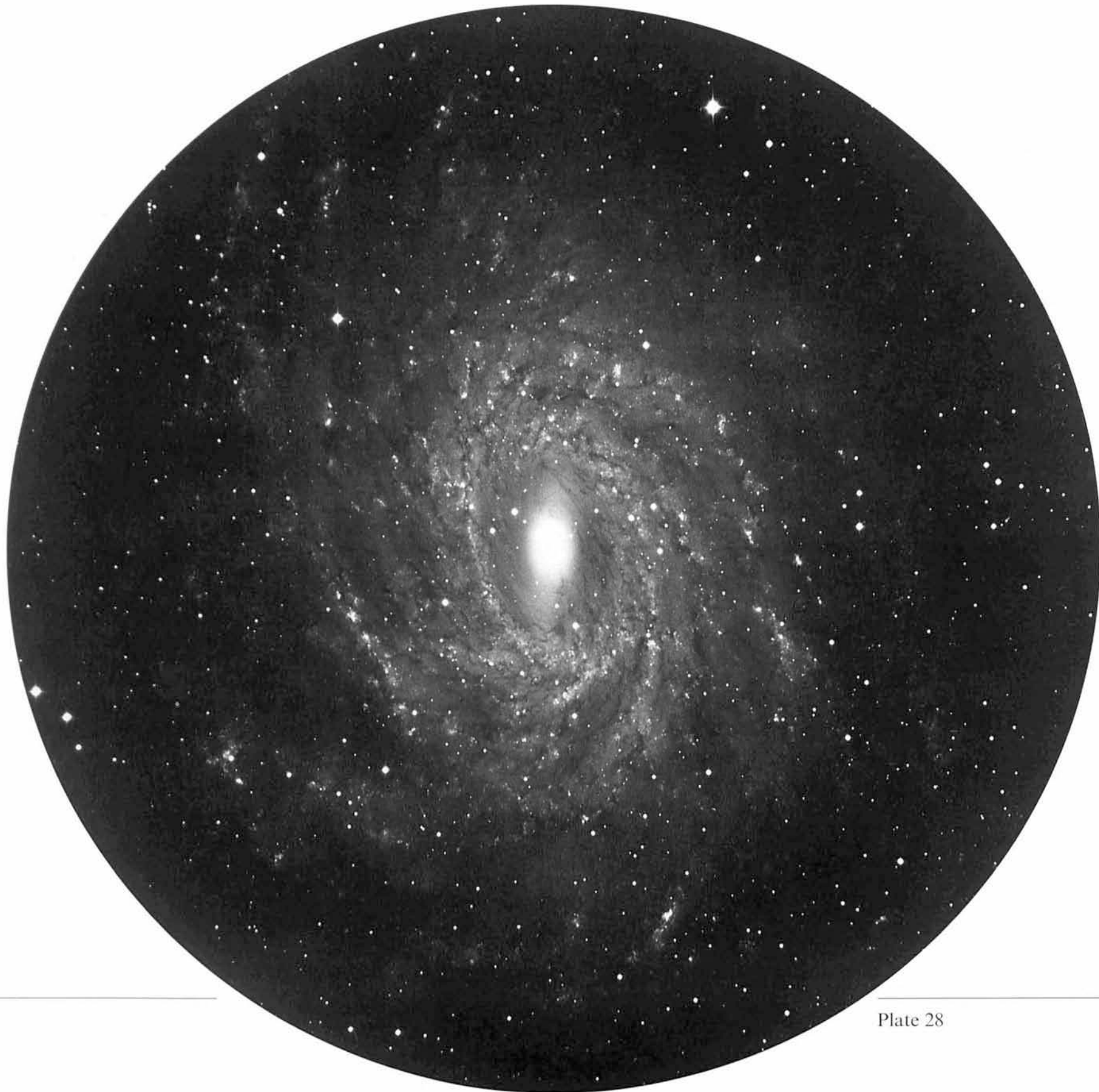

Plate 26



Plate 27



28 NGC 6744 is a beautiful spiral galaxy of Sbc type. Its central part resembles an E3 galaxy. Farther out there is a ring, though less perfect than those seen in other galaxies. The spiral arms spring tangentially from the ring. It is a multiple-arm system with both short and long bits and pieces of arms, some of which extend to great distances. NGC 6744 is remarkably isolated in space. Unlike most galaxies, it does not appear to be a member of any group or cluster of galaxies.

29 NGC 6221 is an asymmetric Sbc galaxy. Its northern arm is long and bright, whereas the southern one is short and faint. Note the crowding of foreground stars in the field. This is because NGC 6221 is at a low galactic latitude ($b = -10^\circ$), close to the so-called "Zone of Avoidance". This is the zone along the galactic equator, where it is difficult, and in some areas impossible, to find any external galaxies, due to absorption in the disk of the Milky Way Galaxy.

30 NGC 1808 is an Sbc galaxy with some peculiarities. This long exposure is dominated by a large and bright central part, with absorbing material that is arranged partly in a ring and partly in radial filaments. The two spiral arms are extremely faint. NGC 1808 is at a distance of 50 million light-years. A number of more distant spirals are also seen in this field.



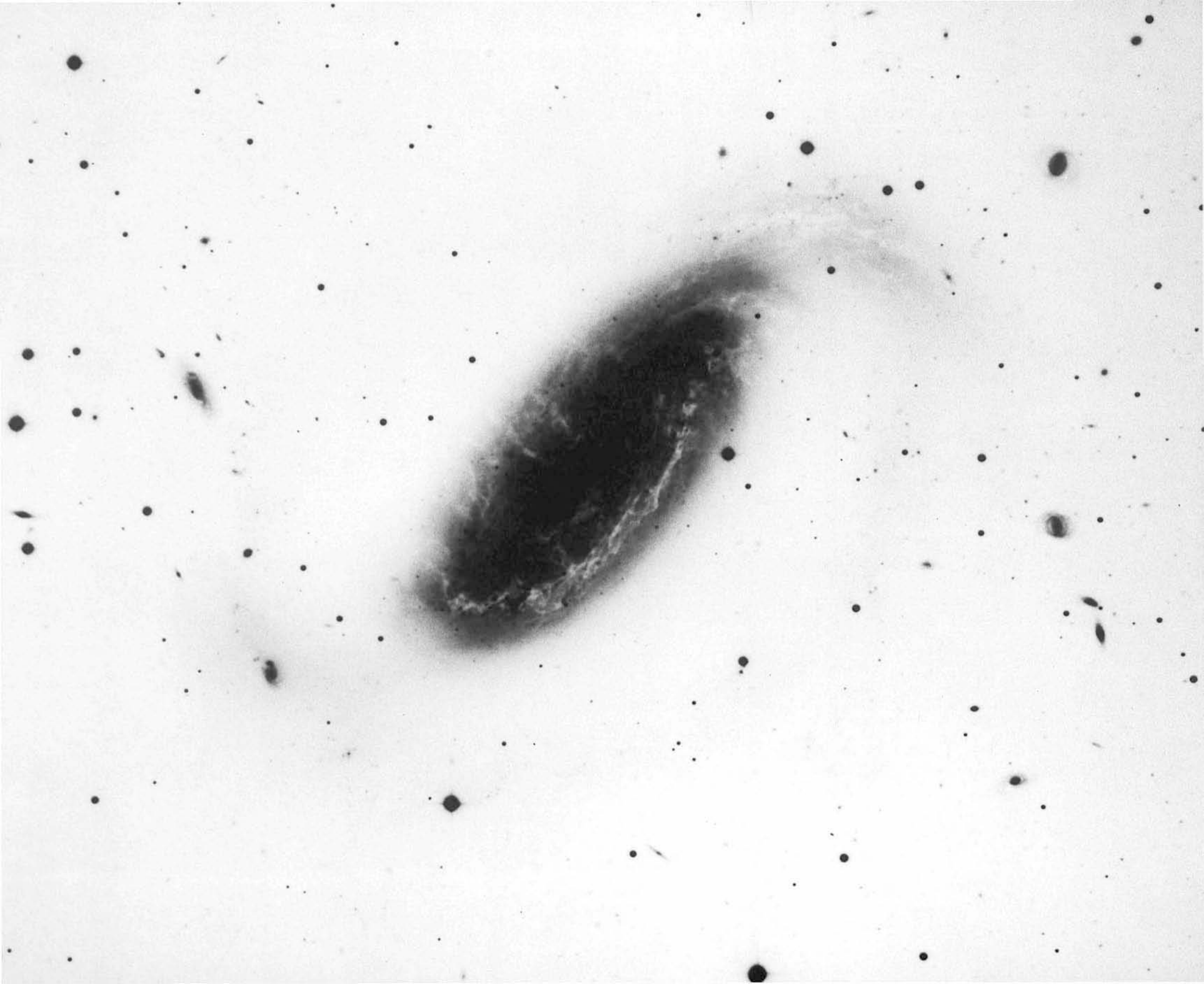

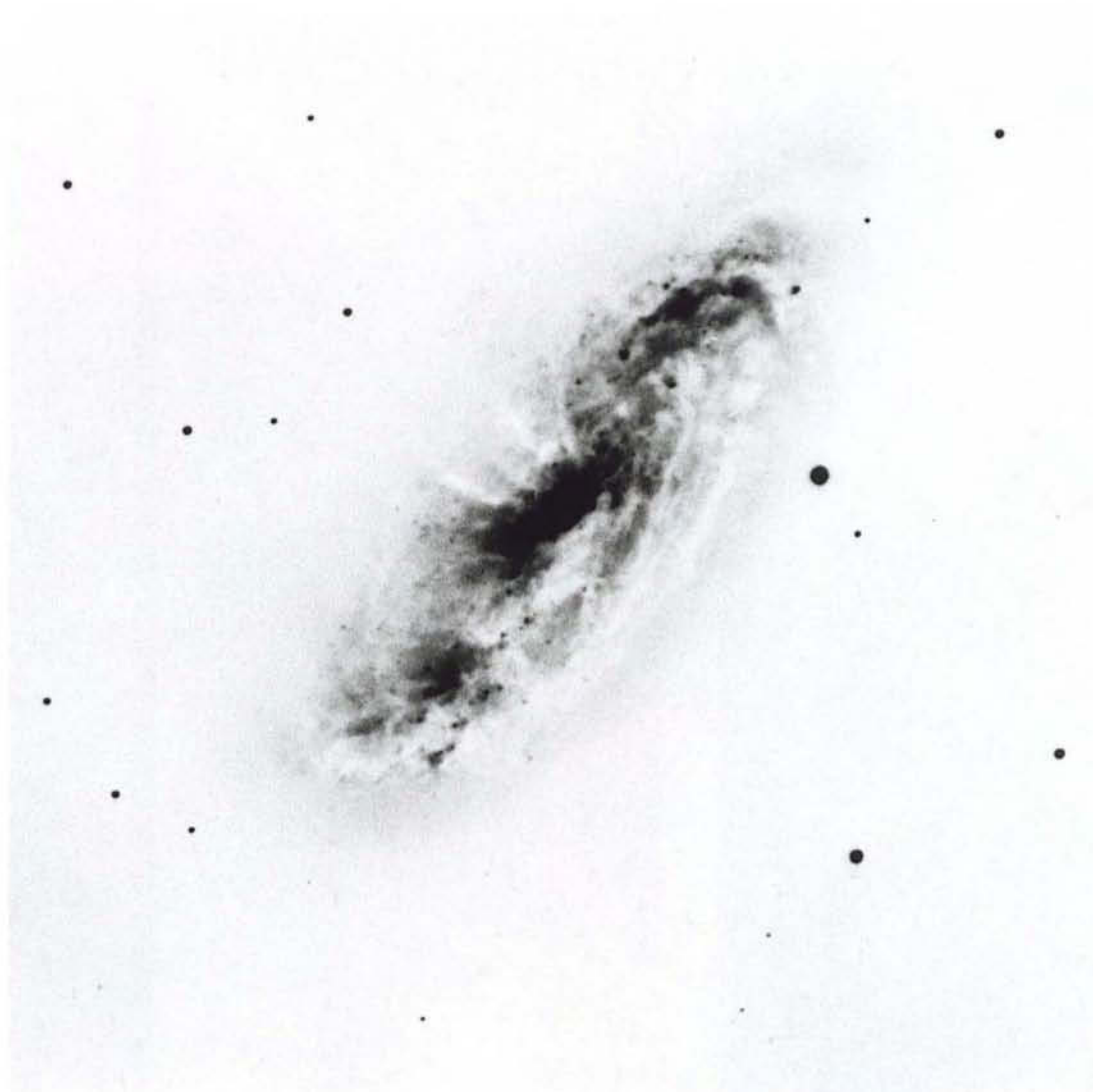

31 Here is NGC 1808 in a short exposure. This negative print gives a good impression of the large amount of absorbing dust in the disk. Again we notice the radial filaments of dark matter, which seem to have been blown away from the centre in a north-easterly direction.

Spectra obtained of the centre show broad emission lines, which are a sign of violent motion in the nucleus. This indicates that NGC 1808 is

of the so-called Seyfert type. Seyfert galaxies are named after the American astronomer Carl Seyfert (1911–1960), and are characterized by having bright nuclei that radiate large amounts of energy.

32 This CCD image of the nucleus of NGC 1808 is made in the same way as Plates 20–27. The field is only 47×47 arcsec, and it shows a star-



like nucleus and two blue “hot spots” to the south-east and north-west of the nucleus. In between we see some reddish areas. Nuclear hot spots are a rare phenomenon.

33 NGC 2997 is a beautiful galaxy and a typical Sc type with two dominant arms. In spite of some ramifications, both arms can be traced for a full revolution. A large branch arising from the south-western outer arm can be followed a long way towards the north.

34 This is a composite CCD picture of NGC 2997. The detector area was too small to cover the entire galaxy. The present picture was therefore made from three overlapping CCD frames. The colours show the intensity contours.

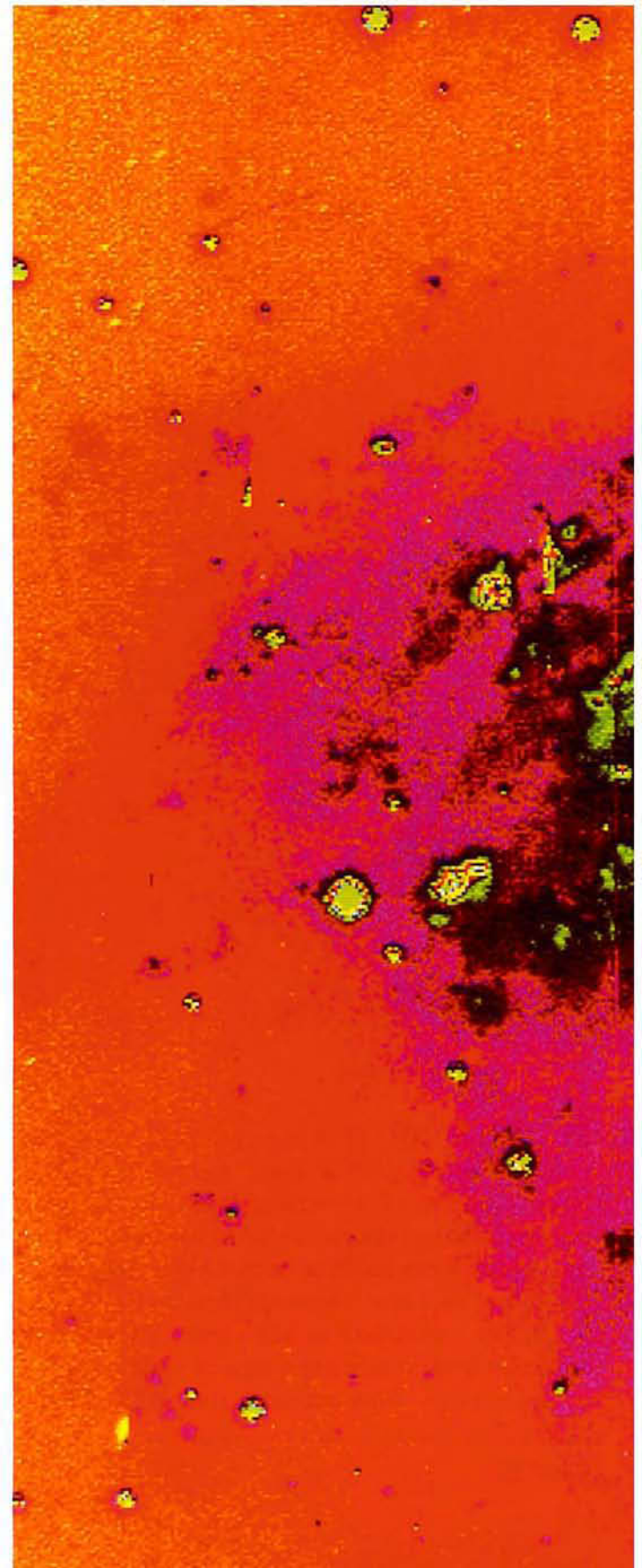

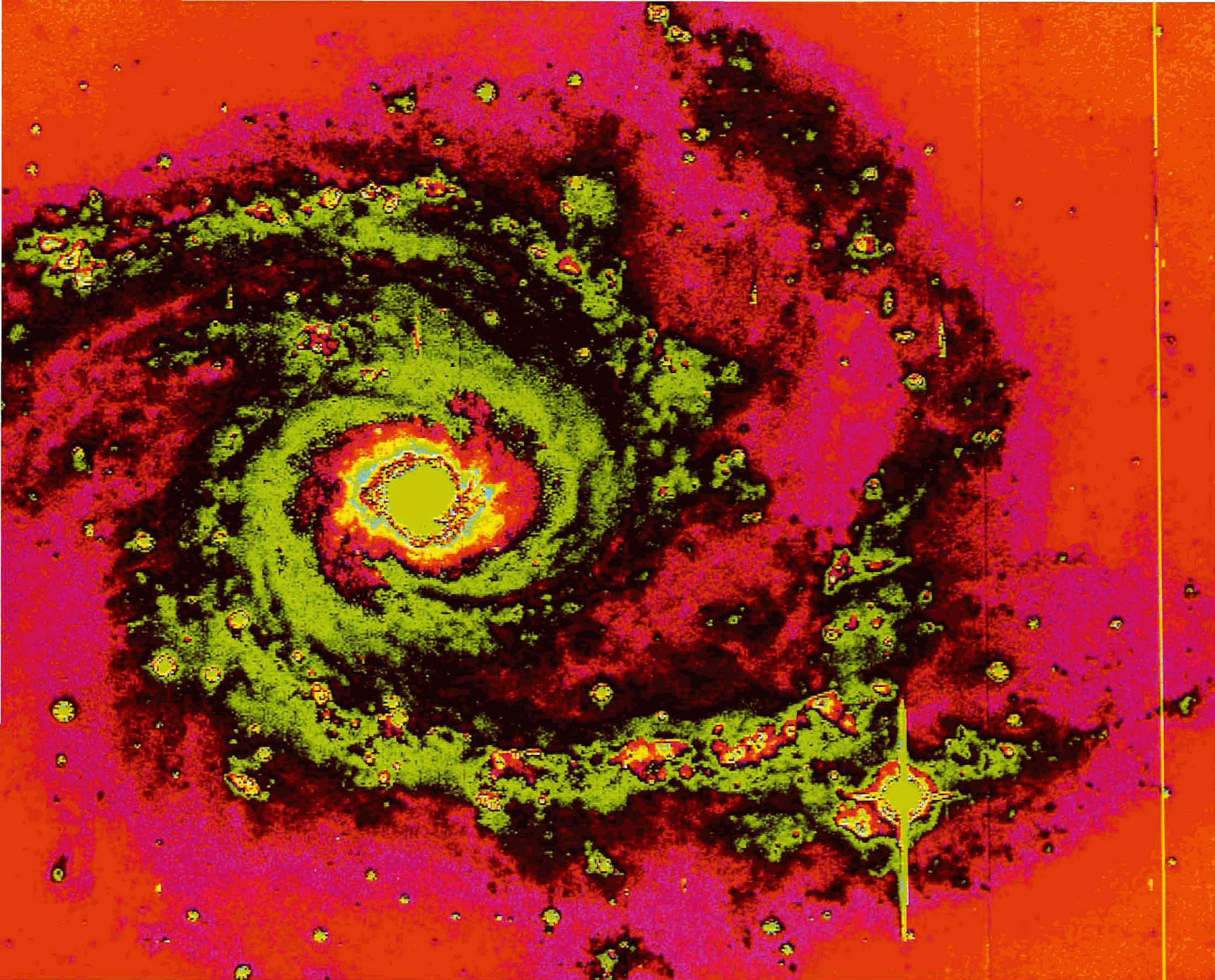



35 At first glance, this galaxy, NGC 4945, contains a confusing mixture of luminous and dark matter. But a closer look reveals that it is possible to trace small sections of spiral arms. NGC 4945 has been classified as an Sc galaxy seen at a steep angle, although not quite edge-on.

36 ESO 60 – IG23 is a spiral galaxy seen almost edge-on. The absorbing effect of the material in the disk is very clear, but a part of the disk is seen in emission like the nuclear bulge.

This is one of the nearly 12000 southern galaxies that were found during the first ESO photographic survey, and which were not contained in any other catalogue of galaxies. Hence the designation.





37 Far south in the constellation of Indus (the Indian) lies the small, nearby galaxy IC 5152. How near is a matter of dispute, but the distance is probably somewhere between 5 and 15 million light-years. The present photo proves that it cannot be much farther away. A large number of individual stars can be seen – in astronomical terms, they are “resolved” – and this would not have been possible if IC 5152 were at a much greater distance. Variable stars of the δ Cephei type have been found in this galaxy. These variable stars are very useful distance indicators, since there is a simple relationship between their luminosity and their period of light variation. When the period has been determined, a comparison of the deduced, intrinsic luminosity and the observed (apparent) magnitude, immediately yields the distance, because the light of any object is dimmed by the square of the distance. Further study of such stars in IC 5152 should therefore make it possible to determine a reliable distance for this galaxy.

In addition, the classification of IC 5152 is uncertain. It could be classified as an irregular galaxy of the Magellanic type. But it does seem to have a small nucleus, and is therefore classified Sd. Even so, it is rather different from NGC 7793 (Plates 8 and 73) and ESO 249-G 36 (Plate 90), two other Sd galaxies presented here.

The bright star north-west of IC 5152 has the designation HD 209142. It is a foreground star in the Milky Way that is of 8th magnitude. Despite its apparent brightness in this picture, it is still too faint to be visible to the naked eye.

BARRED SPIRAL GALAXIES

Barred spirals have straight and often broad bars that cross the central bulge. The spiral pattern may be connected to the bar in two different ways. Either two spiral arms emerge from the ends of the bar (as in the case of the beautiful SBb galaxy NGC 1365, see Plates 4 and 5), or the spiral arms emerge from a ring encircling the bar. Such a ring is called the *inner ring*.

38 NGC 6684 is a difficult case. At first glance it looks like a large nuclear bulge surrounded by a perfect ring. But the spiral arms would then be missing. A closer look resolves the ring into two tightly wound spiral arms, somewhat distorted by the projection effect. It is a fine example of an SBa galaxy.

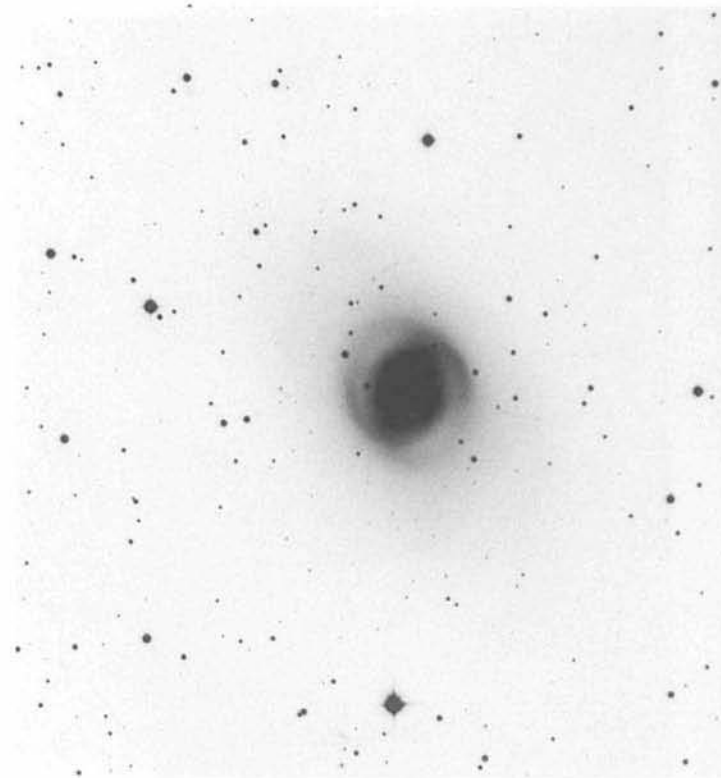

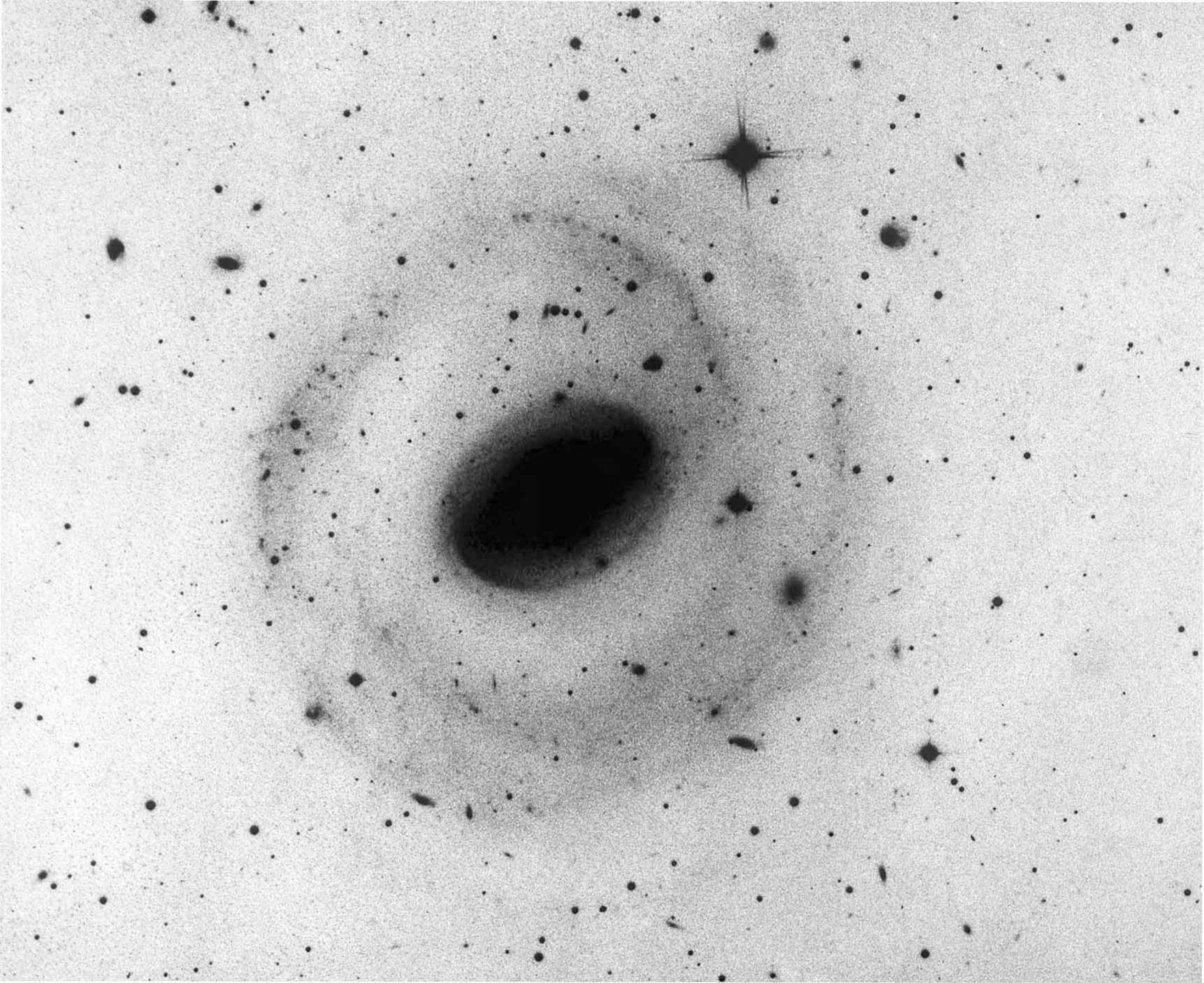

39 In this high-contrast print of NGC 5101, most of the centre is overexposed, but an inner ring is just visible. Here, the spiral arms seem to have little or no connection with the inner ring. In fact the spiral arms form another ring-shaped structure, which is called the *outer ring* of the galaxy.

NGC 5101 is an SBa galaxy at a distance of around 80 million light-years. It appears to be surrounded by several much fainter galaxies, but those actually belong to a more distant cluster of galaxies.

40 This is a less-exposed print from the same original photograph that was used for Plate 39. Here we can see the central part much better and the inner ring is resolved into two tightly wound spiral arms. Clearly, NGC 5101 is a barred spiral galaxy, although the bar has an unusual appearance.



41 NGC 6300 is an SBb galaxy. It has a somewhat irregular ring and a number of short arms. The central part looks strange because two relatively bright foreground stars of the Milky Way happen to be projected onto it.

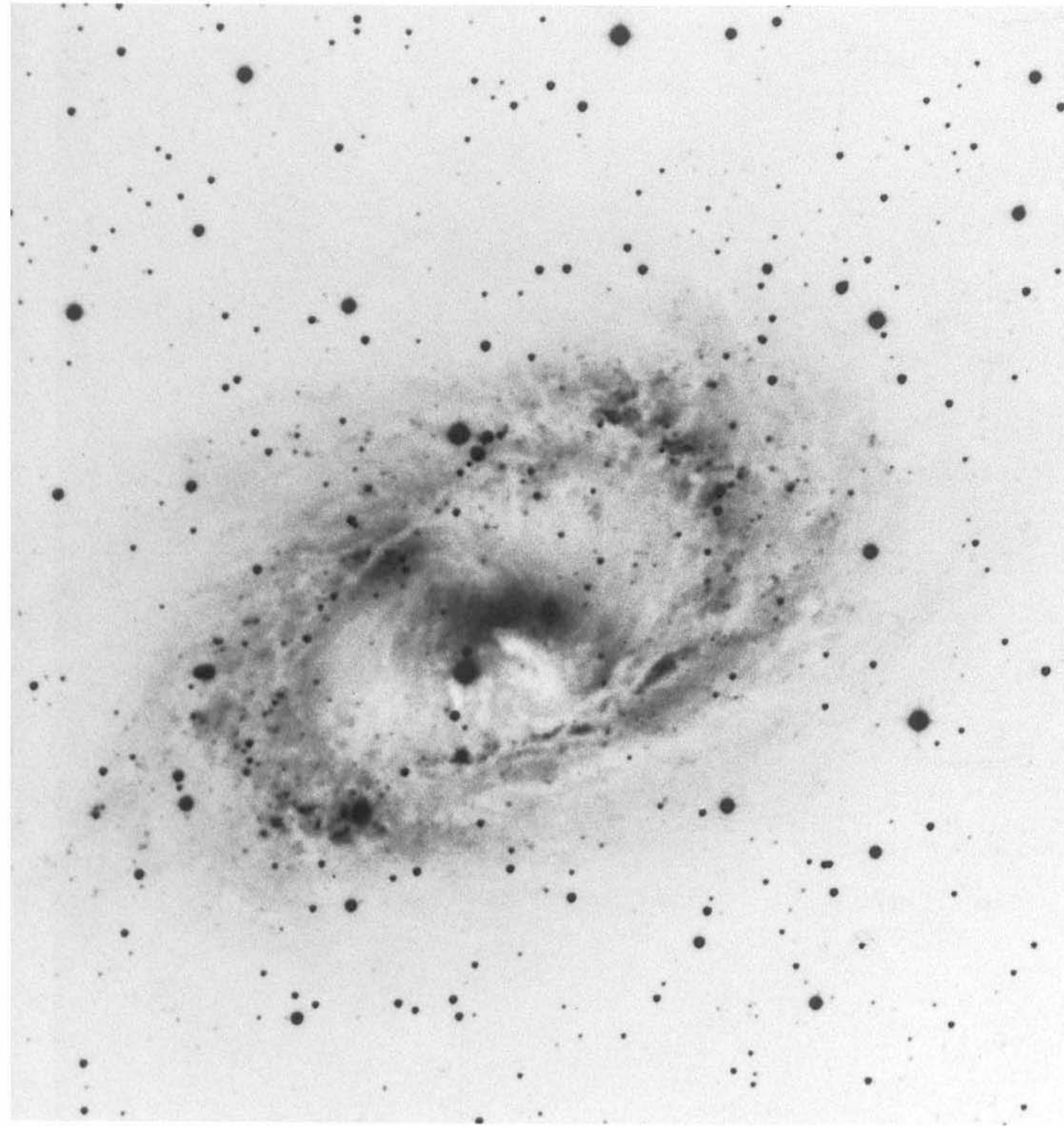

42 NGC 2442 is an SBba galaxy with two well developed spiral arms. Its central bulge is small, and its bar is to a large extent hidden by dust clouds. It is a very dusty galaxy. Dust clouds are present almost everywhere, but particularly in a broad lane along the northern spiral arm.

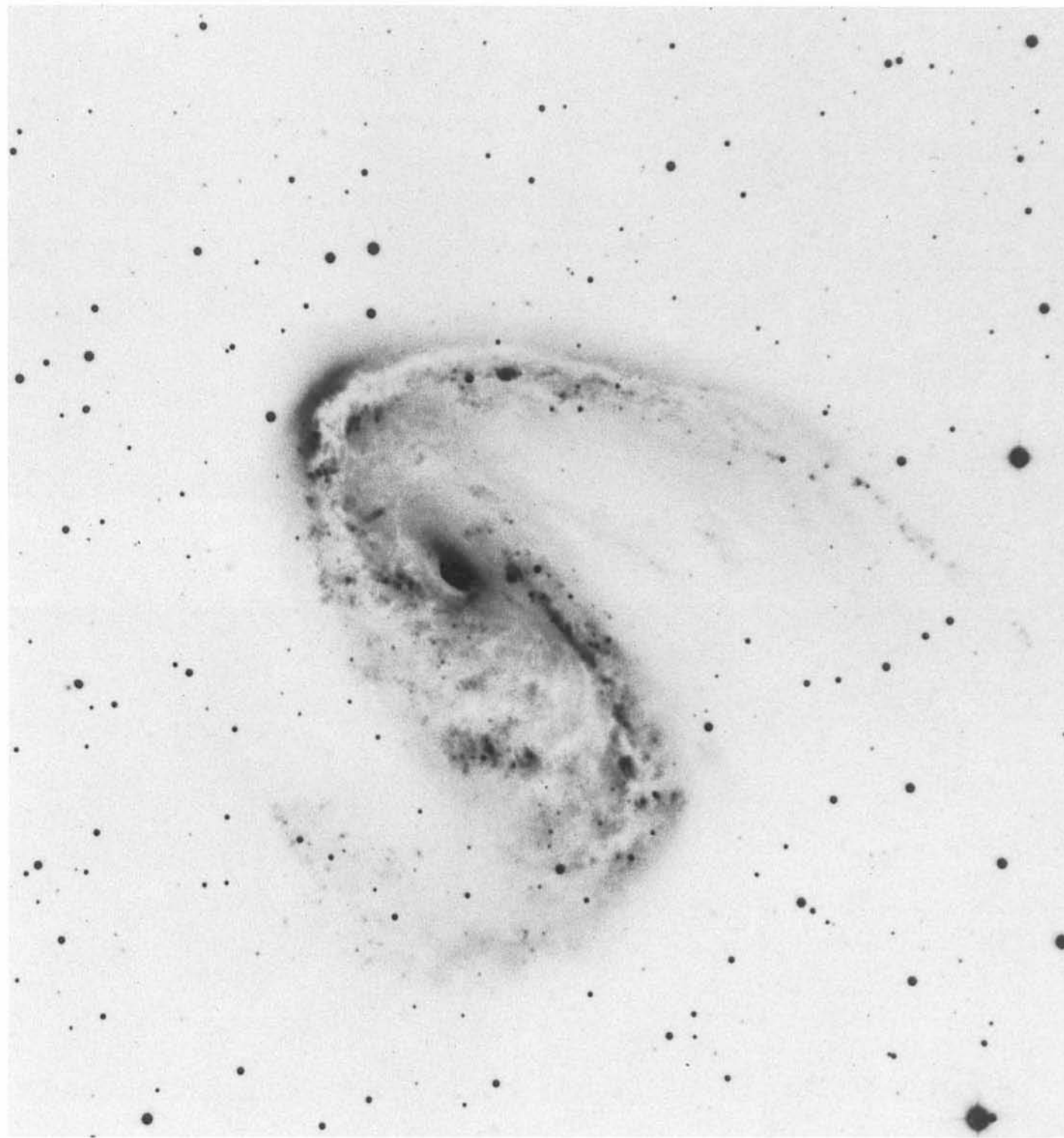



Plate 43



Plate 44



Plate 45



Plate 46

COLOUR PICTURES OF BARRED SPIRALS
TAKEN WITH A CCD CAMERA

These four pictures are made in the same way as Plates 20–27.

43 NGC 357 is an SBa galaxy with a very large nuclear bulge.

44 NGC 289 is an SBbc galaxy. The red nuclear bulge is partly obscured by dust lanes. The inner parts of the spiral arms form an incomplete ring.

45 NGC 6923 is also an SBbc galaxy. Note here the rows of faint blue knots along the spiral arms, and which are areas of recent star formation.

46 NGC 7496 is an SBc galaxy with two arms, which tend to split up in certain areas. Here too there are many blue areas of star formation.

47 NGC 5236 (or M 83) is an impressive spiral that has been classified as SBc. It has two main arms with a large number of branches. Some of the branches are attached almost at right angles to the main arms.

This object was included as No. 83 in the catalogue of Charles Messier (1730–1817), a French astronomer and famous comet hunter. Towards the end of the 18th century he made a small catalogue of bright diffuse objects that at a quick glance could be mistaken for comets. His numbers for some 100 objects are still widely used today. Some of the objects later turned out to be galaxies, and M 83 is the southernmost of these.



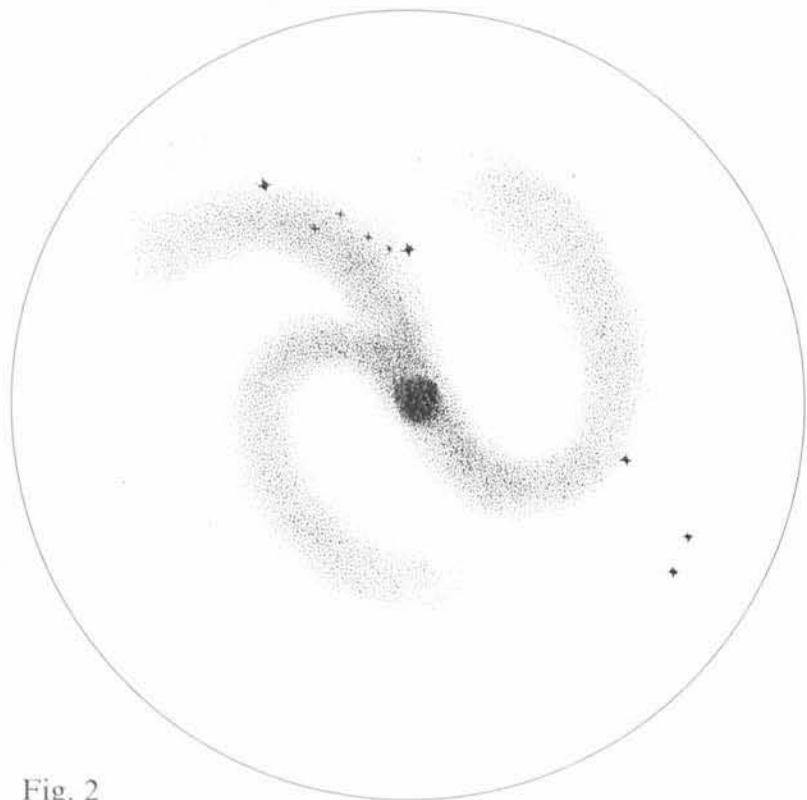
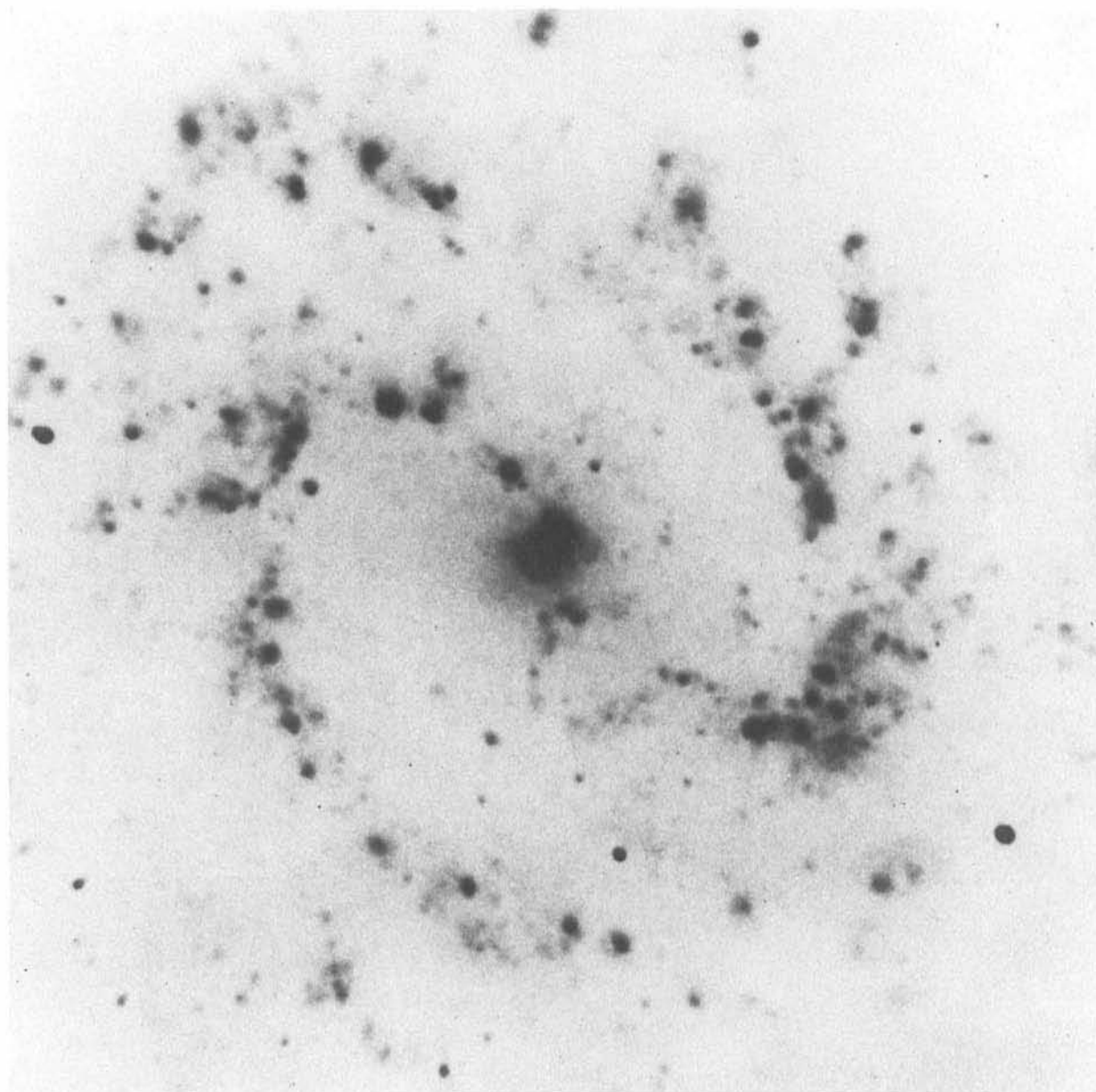
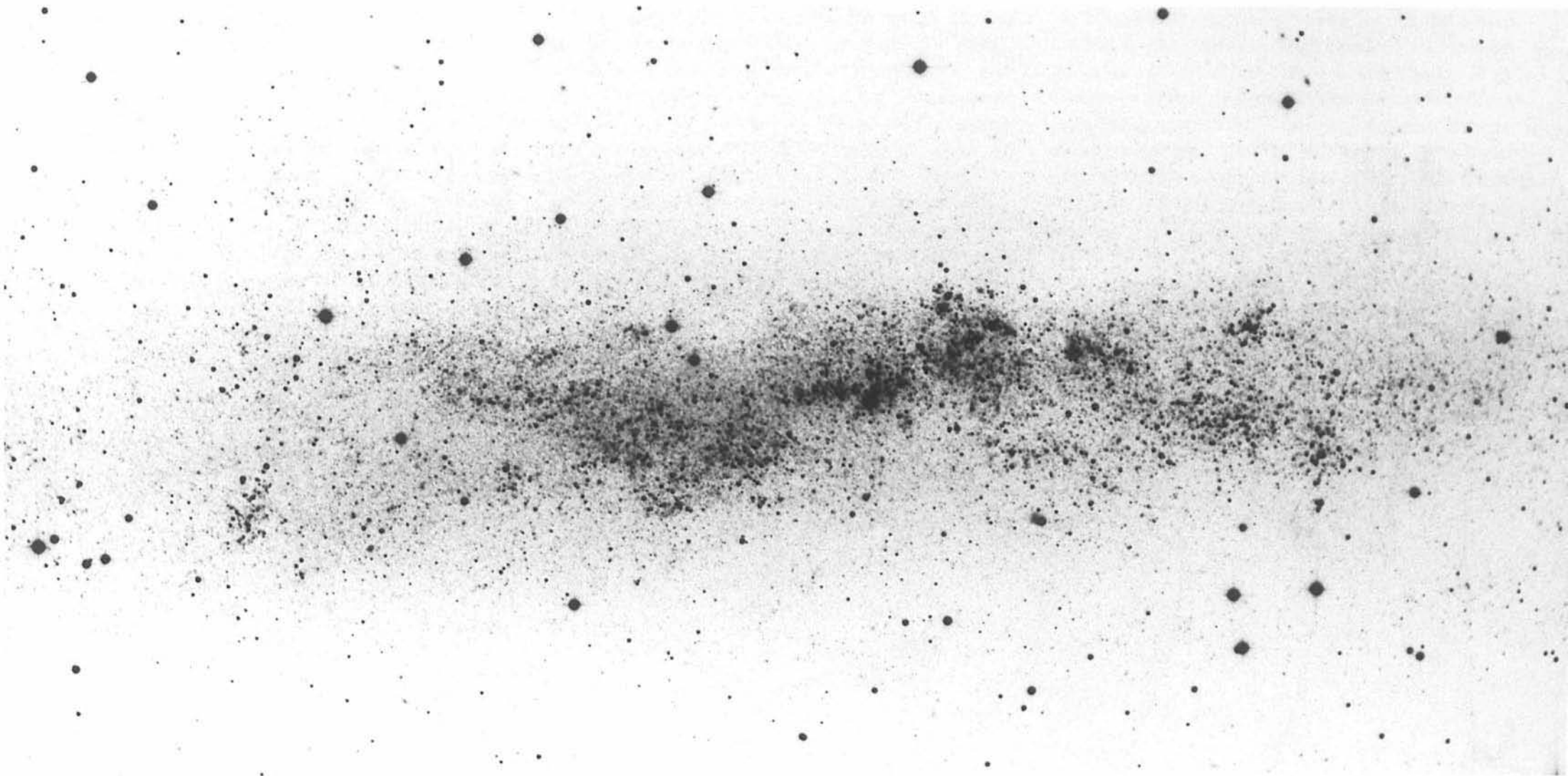

Fig. 2

M 83 is one of the few galaxies in which spiral structure was known before the photographic plate was introduced in astronomy in the middle of the 19th century. The English astronomer William Lassell (1799–1880) observed it from Malta. For a while he had a telescope installed there, and from visual observations he made a drawing of M 83 with a clear indication of its spiral arms. This drawing is reproduced in Fig. 2.

48 This is a photo of M 83 exposed in the emission line of H_{α} . It shows, in particular, the regions of ionized gas, and it can be clearly seen that these regions are beautifully aligned along the spiral arms.





IRREGULAR GALAXIES

At the end of the Hubble sequence we come to the Irregular Galaxies, which have no nucleus and no nuclear bulge. Into this group fall most galaxies that cannot be classified as ellipticals

or spirals. Some irregular galaxies may have a bar or a bar-like component.

The best known irregular galaxies are the two Magellanic Clouds (Plates 50–65). Irregulars of the same type are called Magellanic which is indicated by a small *m*. They have a composition similar to the one found in the disks of spiral galaxies. They contain much gas and much dust, and they are active in the formation of new stars.

49 NGC 3109 is an Im galaxy close enough to be resolved into a crowd of individual stars. Even so, it is still only the most luminous stars that can be seen in the picture. Less luminous stars, like those similar to our Sun, are too faint to be resolved here. They just contribute to the amorphous background light of the galaxy.

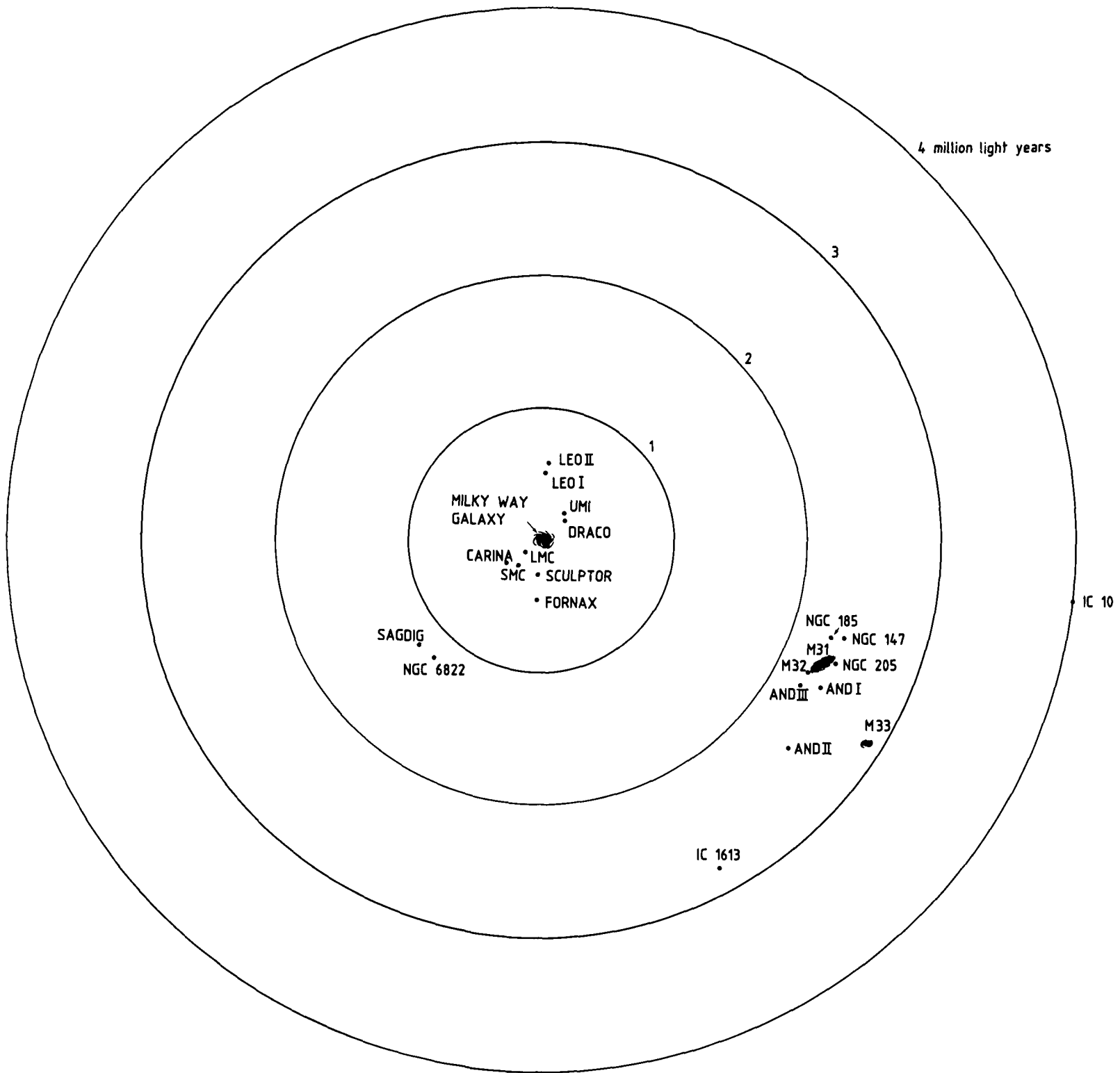

Fig. 3

1.3 *The Local Group*

As mentioned earlier, most galaxies form part of groups or clusters of galaxies. Our own Galaxy is a member of the *Local Group*, a somewhat loose, moderate-size group of galaxies with about 30 members. The extent of the Local Group is limited to a diameter of about 10 million light-years. A galaxy can only be gravitationally bound to the group if it is less than about 5 million light-years from the common centre of gravity.

The dominant member of the Local Group is the Andromeda Galaxy, a giant Sb spiral, which is about three times more massive, and three times more luminous than our own Galaxy. Indeed, it appears that the Andromeda Galaxy is more massive and more luminous than all other members of the Local Group added together. Second in the list according to size is the Milky Way Galaxy, followed by a third spiral, M 33, and the two irregular galaxies, the Large, and the Small Magellanic Clouds. All the remaining, approximately 25, Local-Group galaxies are small, each less than 1% of the size of the Andromeda Galaxy. They are all in the category of dwarf galaxies. Due to their faintness, such dwarfs are difficult to detect in distant groups and clusters of galaxies. Those in the Local Group are more conspicuous because of their proximity. Even so, several of the fainter ones were only detected with large telescopes during the last few decades.

The distribution of galaxies within the Local Group is not uniform. One third of the known galaxies are crowded close to the Milky Way Galaxy within a distance of less than one million light-years, one third is situated around the Andromeda Galaxy, and the last third is spread out over a much bigger volume. This distribution is illustrated in Fig. 3, in which most of the galaxies are projected onto the so-called supergalactic plane.

A natural question is whether the Local Group is an isolated entity in the Universe. The answer is no; the Local Group forms part of a much larger body, a supercluster of galaxies called the *Local Supercluster*. This is a huge system, composed of thousands of galaxies. We shall return to this, but let us first have a closer look at the Local-Group galaxies.

50 This wide-angle photograph shows the two Magellanic Clouds, outside the band of the Milky Way. The *Large Magellanic Cloud* (LMC) is situated 33° from the galactic equator and the *Small Magellanic Cloud* (SMC) is 44° from that line. Both are fairly close to the celestial South Pole, as seen in Fig. 4. The brightest stars in the field are α Carinae (also called Canopus), α and β Centauri and the four stars in Crux forming the *Southern Cross*. In the Milky Way, note the bright area in Carina, and the *Coal Sack* next to the Southern Cross. Close to the Small Magellanic Cloud is one of the brightest globular clusters in our Galaxy, 47 Tucanae, or NGC 104 (see also Plate 175).

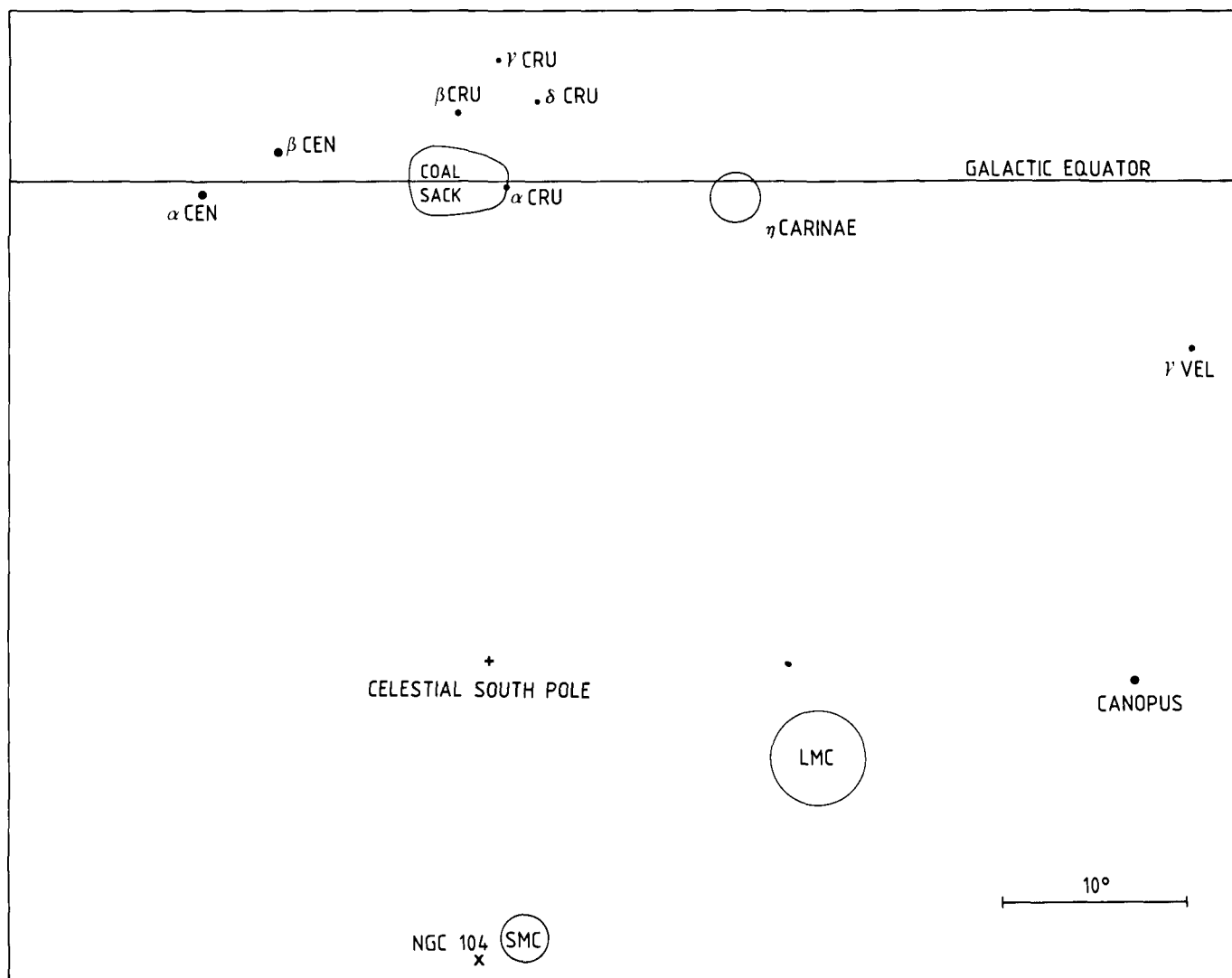

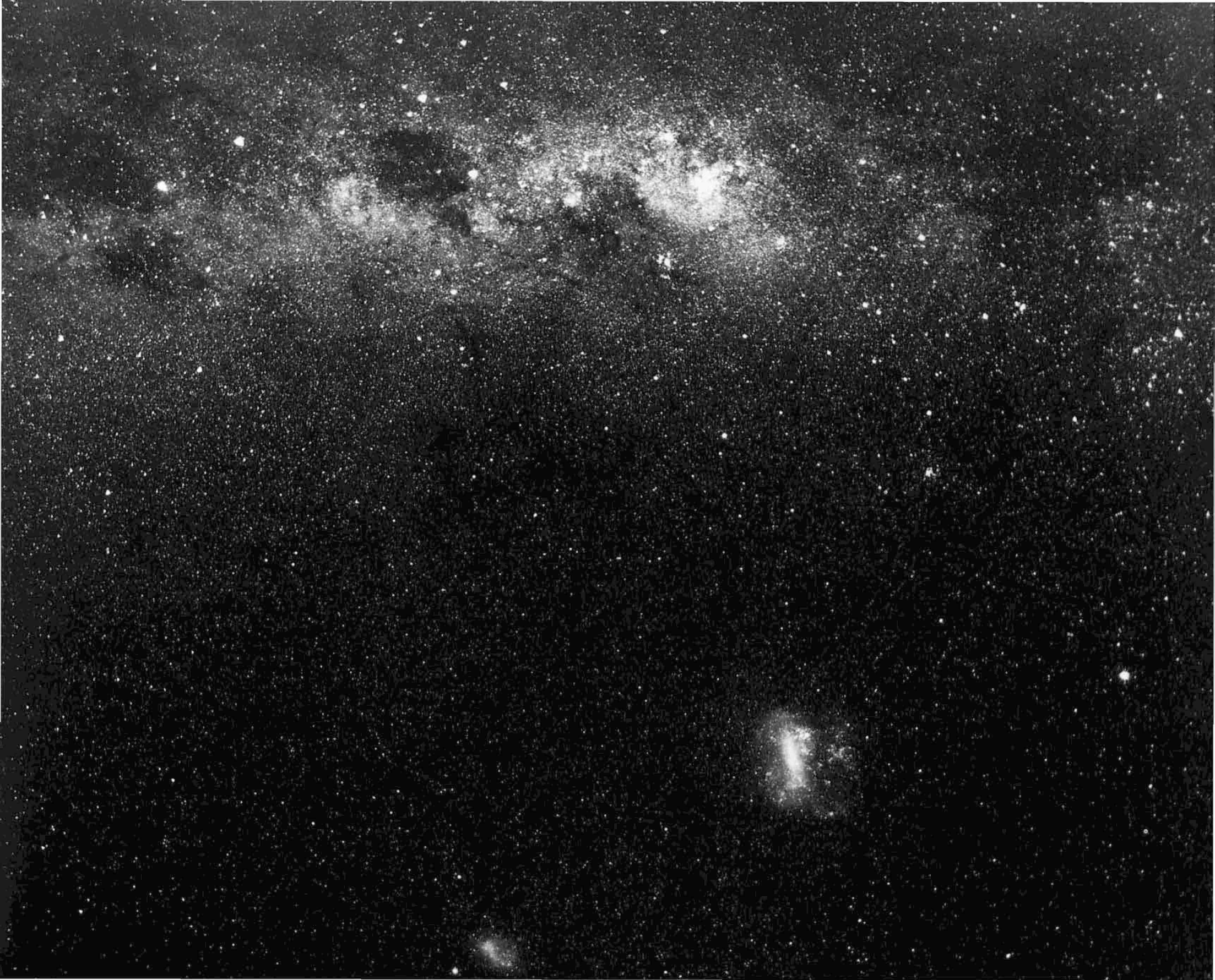

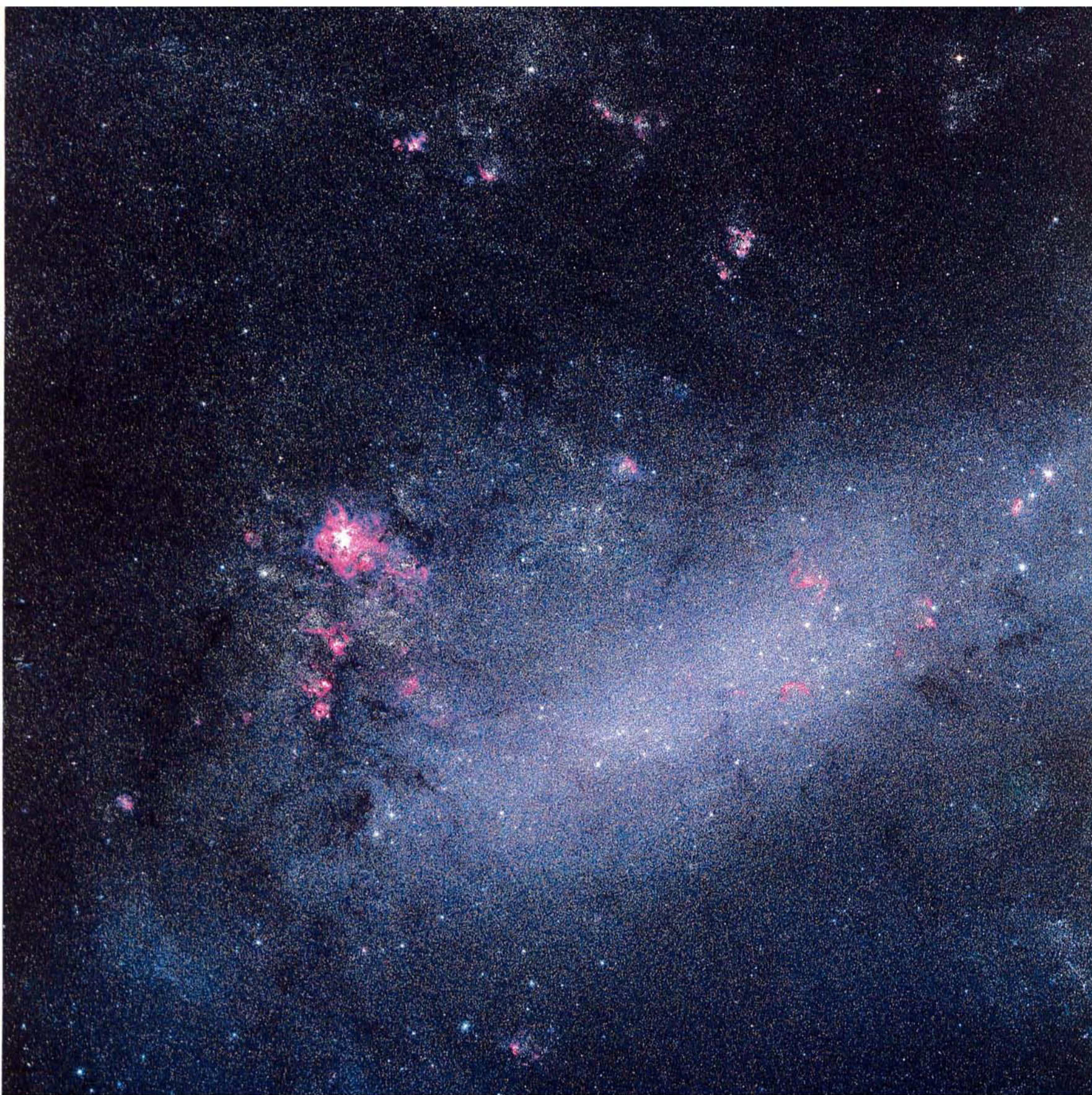

51 The Large Magellanic Cloud is our closest neighbouring galaxy in the Universe. Its distance is 180000 light-years, which is only a little more than the diameter of our own Galaxy. The classification of the LMC is a matter of some dispute, but since it has a bar-like structure it seems reasonable to call it an irregular galaxy of the IBm type. Due to its proximity, the bar can be resolved into myriads of stars.

A large number of stellar clusters are visible on the Plate, particularly in and near the bar. The brightest of these are marked in Fig. 5, with their NGC numbers. The clusters in the LMC play a major role in the study of the evolution of this stellar system. Their geometrical shapes are similar to those of the globular clusters in our Galaxy. But, whereas the latter are all old, and mainly tell us about the early history of our

Galaxy, the clusters in the LMC cover a large range of ages. They therefore carry information about the entire lifetime of the LMC. The oldest LMC globular clusters are estimated to be 12 billion years old while the age of the youngest is only about 10 million years. It appears that during billions of years stars were formed rather slowly in the LMC. Then, at a certain epoch, a lot of stars were suddenly born, or as astronomers express it, a major *burst of star formation* took place. Consequently, most LMC stars have ages around 3–5 billion years, and many are younger, but few are older.

Emission nebulae are seen everywhere in this field. Their red colour is due to strong emission in the hydrogen line, H_{α} . The largest nebula is the 30 Doradus complex, NGC 2070. Other fairly large ones are here identified with their number, N, in a catalogue that was published in 1955 by the American astronomer and astronaut, Karl Henize.

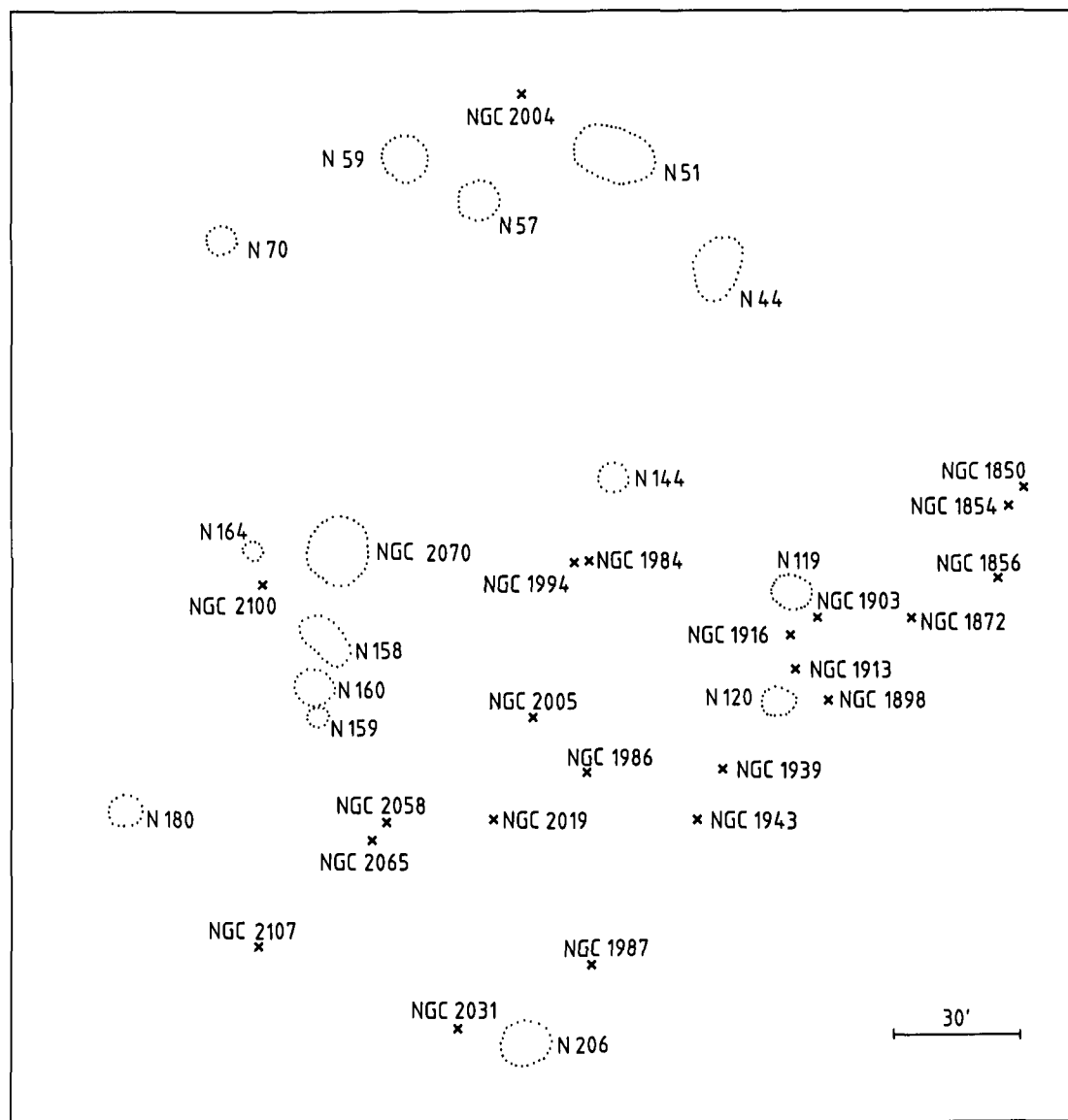

Fig. 5



52–53 The brightest supernova in this century exploded in the Large Magellanic Cloud, on February 23, 1987. Plate 52 was taken early in the morning on that day, just a few hours before the violent explosion happened, about 20 arc-minutes southwest of the 30 Doradus complex. The following Plate (no. 53), which was taken with the same equipment, shows the LMC on February 25, exactly 48 hours later. The supernova can clearly be seen by comparison of the two photographs.

This supernova, now designated as 1987A, was the brightest in the sky since Johannes Kepler observed one in the constellation Ophiuchus in the year 1604. Astronomers at all observatories in the southern hemisphere immediately turned their attention to this unexpected event. No less than 13 telescopes at La Silla observed 1987A during the first nights and several of the smaller telescopes continued observations during many months thereafter.

It was a hot, heavy star of magnitude 12 that exploded and within a few hours, its brilliance rose more than 2000 times. In late February, it paused a while, but from early March on, it continued to brighten. By mid-May, it reached a maximum near magnitude 2.8. Photometric and spectroscopic observations showed that it was surrounded by a dense envelope of stellar material which was expanding into the surrounding interstellar space. The velocity of this expansion soon decreased to around 10000 km/s and the temperature of the envelope quickly fell to around 5000 K. Infrared measurements determined the size of the envelope to around 5000 times the diameter of the Sun on March 1, 1987, that is about the size of the orbit of planet Neptune.

54 The area around supernova 1987A is full of interstellar matter. It may even be embedded in the outer parts of the giant 30 Doradus complex. This has become clear when high dispersion spectra were obtained. They showed narrow absorption lines from no less than 24 individual gas clouds, most of which are situated in the Large Magellanic Cloud and in our Galaxy. Some of them, however, lie in the intergalactic space between the two galaxies. These observations also demonstrated the presence of for instance Lithium and Potassium in interstellar clouds within the confines of the LMC.

Observations of SN 1987A will continue for many years to come. For the first time, astronomers have the opportunity to follow the development of a supernova, from the moment of explosion until the ejected matter disperses in interstellar space.

55 This enlargement of the central part of Plate 51 shows more clearly the beautiful nebulae and the star clouds in the LMC bar. Nebula No. 119 in Henize's catalogue, N 119, is an unusual object. At a first glance it appears to have a spiral form, but a closer inspection reveals faint extensions of the "spiral arms"; it then takes the shape of the figure "8". The area is dotted with clusters of the open type, in which the stars are not concentrated towards the centre as they are in globular clusters. One such cluster is at the very centre of N 119. Its brightest star is *S Doradus*, a very hot and luminous supergiant. The region is clearly one of recent star formation, and emission nebulosity might be expected here. But the shape of N 119 is surprising and cannot be easily explained. It may possibly be the result of one or more supernova explosions, but this hypothesis is not supported by radio observations. Or it may perhaps consist of interstellar material swept together by strong stellar



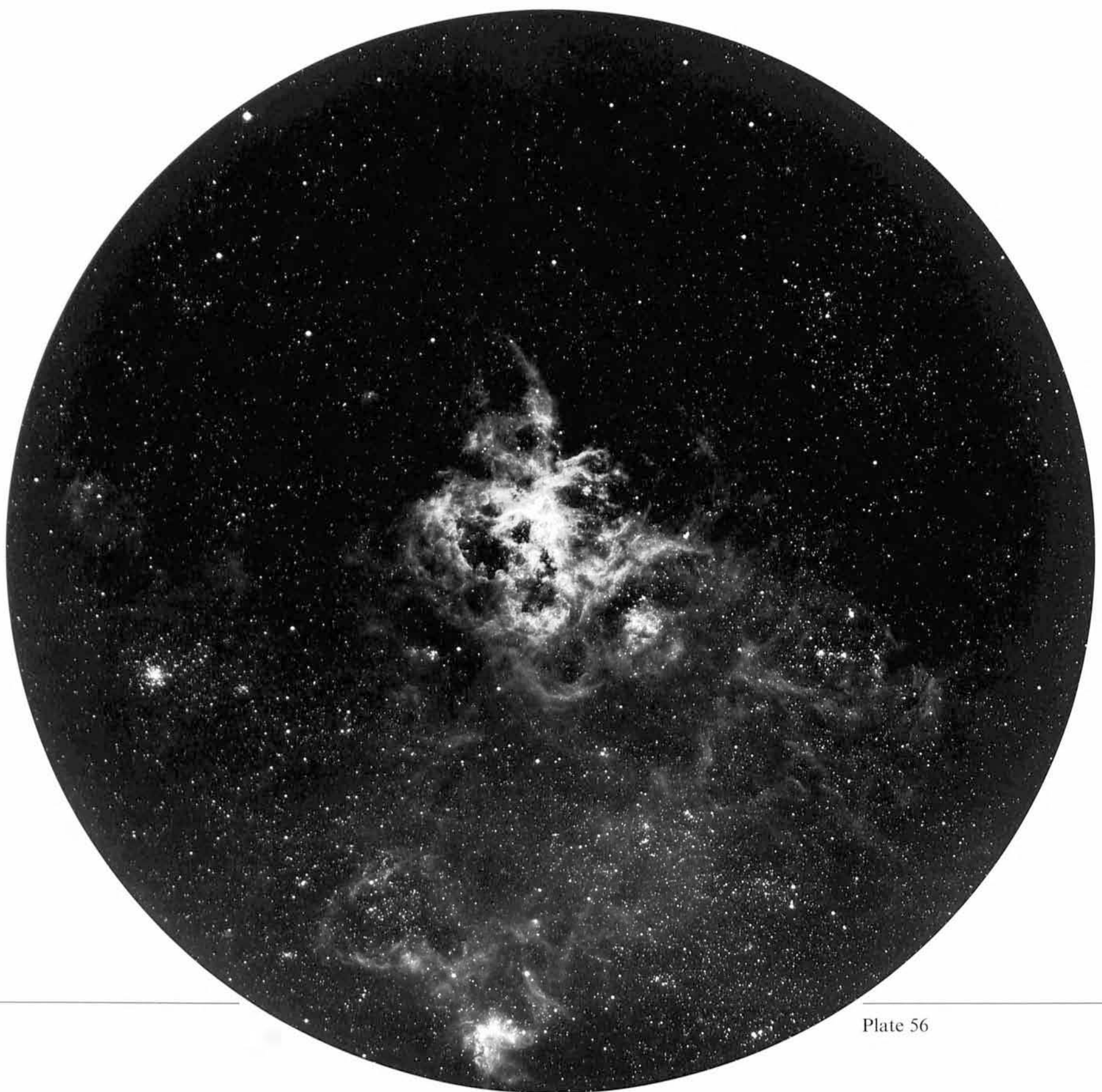

winds blowing from S Doradus and other stars in the cluster. But how can we explain its strange form? Nobody knows for sure, and the study of this object continues, at La Silla and elsewhere. Later in this book we shall touch upon various mechanisms for the production of large shells of interstellar matter (see for instance Plates 63, 125 and 138).

56 30 Doradus, which is also known as the *Tarantula nebula* because of its shape, is one of the most fascinating gaseous nebulae in the sky. Its size is enormous, and the mass of its luminous gas amounts to half a million solar masses. The cloud seen here has a diameter of 600–700 light-years, but as we shall see later (Plate 58), there are faint, nebulous filaments which reach out to a much larger diameter. Spectroscopic measurements show that the 30 Doradus complex is a region of violent motion; this is also our immediate impression when looking at the photo. The processes in action here are similar to those described in connection with the Orion Nebula (Plate 127). But in 30 Doradus it all happens on a much larger scale.

Some astronomers believe that 30 Doradus is the nucleus of the Large Magellanic Cloud. If that is true, it would be unique among galactic nuclei by being so little obscured, and therefore so favourably placed for astrophysical studies, including by optical methods. Other astronomers, however, feel that it is not very centrally placed in the LMC, and that it is highly questionable whether it really plays the role of a nucleus in the LMC.

57 This short exposure of the core of the 30 Doradus nebula shows its central cluster of stars. Many of these stars are hot and luminous. Their combined, energetic ultraviolet radiation is the main source for the ionization of the nebula, a process that is responsible for its brilliance. However, a nebula as large as 30 Doradus needs a great deal of radiation to persist, and for a long time the visible stars have been considered too few to keep the process going. The big unknown is the unresolved luminous “spot”, which is here visible just below the centre of the plate, and which apparently consists of stars. Does it contain the missing energy source? It has been suggested that a supermassive star of enormous luminosity may be hiding within this spot. Advanced observational methods (for instance Speckle Interferometry) have been used in attempts to look inside the mysterious spot. This difficult work has been partly successful, but full resolution and a complete description of the central area in 30 Doradus have not yet been achieved. It is, however, most likely that the core contains several, very hot, but otherwise quite normal, O-type stars, and a few stars of the so-called Wolf-Rayet type (see Plate 132). In that case the total number of hot stars in the cluster would provide sufficient energy for the 30 Doradus nebula to shine as brightly as it does.

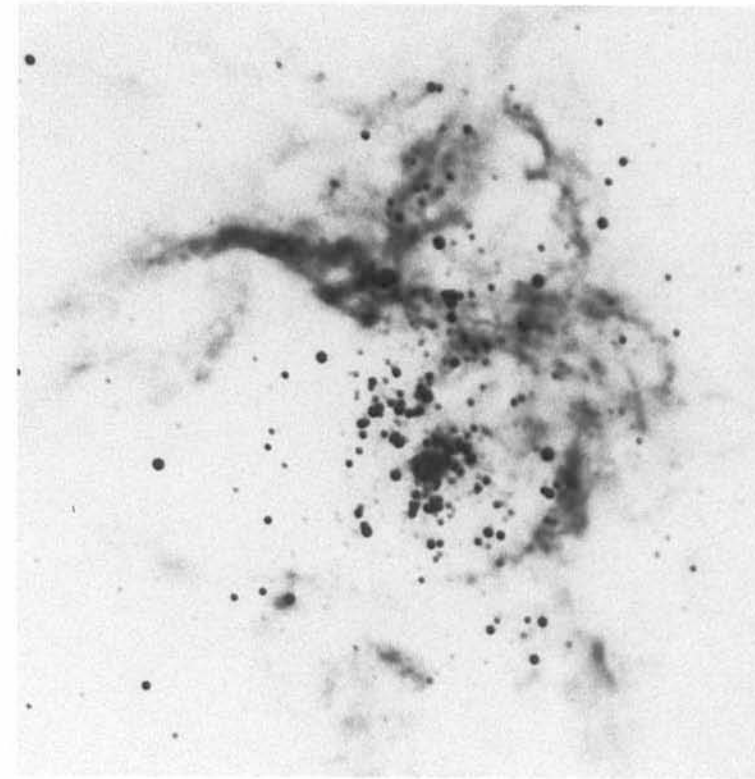

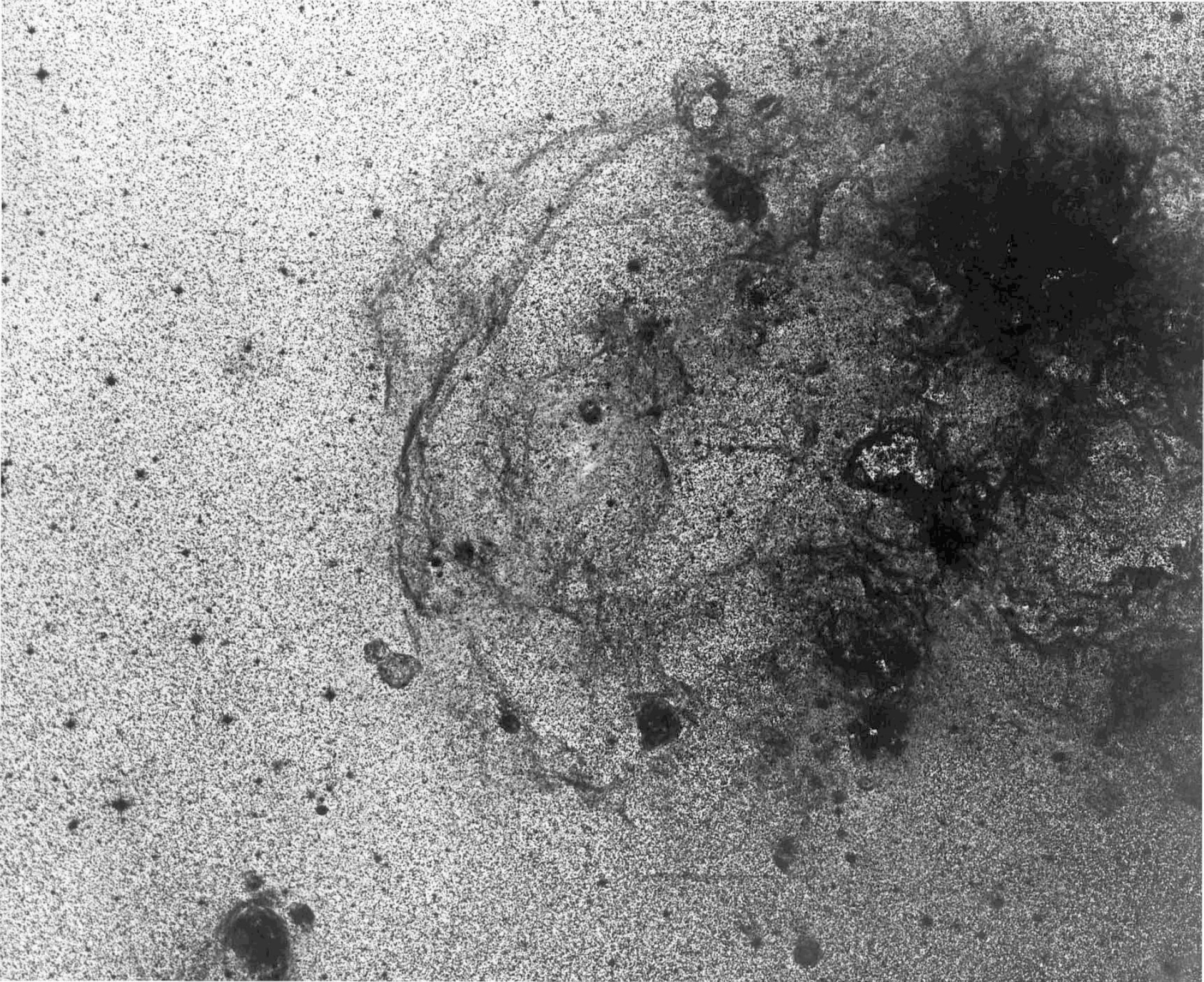

58 While in the previous Plate we tried to look into the heart of 30 Doradus, this photo illustrates the enormous extent of the surrounding nebulous filaments. Most of these filaments are quite faint, and the Schmidt plate, which was exposed to red light, including the H_α line, had to be photographically enhanced in order to show them as clearly as possible. The nebulous filaments can be traced to an angular distance of nearly one degree from the centre of 30 Doradus, and the structure corresponds to an enormous, nebulous bubble with a diameter of 6000 light-years. Inside this bubble, many smaller bubbles of luminous gas are seen. Some of the smaller ones look like spheres. They are usually called Strömgren spheres, because the Danish astronomer Bengt Strömgren was the first to describe their physics. Others are transparent in their central regions and appear as rings or shells.

The overall history of this giant complex is not very well known. Several associations of O and B stars (see Plate 126) are found in the field, and they provide sufficient energy to produce the moderate-sized bubbles of luminous gas mentioned above. But it is hard to identify an adequate source of energy for the formation of the giant bubble. The amount of energy needed for its formation is so huge, that probably nothing but supernovae could provide it. As in the case of the largest known nebula of luminous gas in the Milky Way Galaxy – the Gum Nebula with a diameter of 800 light-years (Plate 134) – it is now assumed that supernovae played the major role in its formation, and that the maintenance of the ionization is taken care of by the many hot stars in the OB associations.

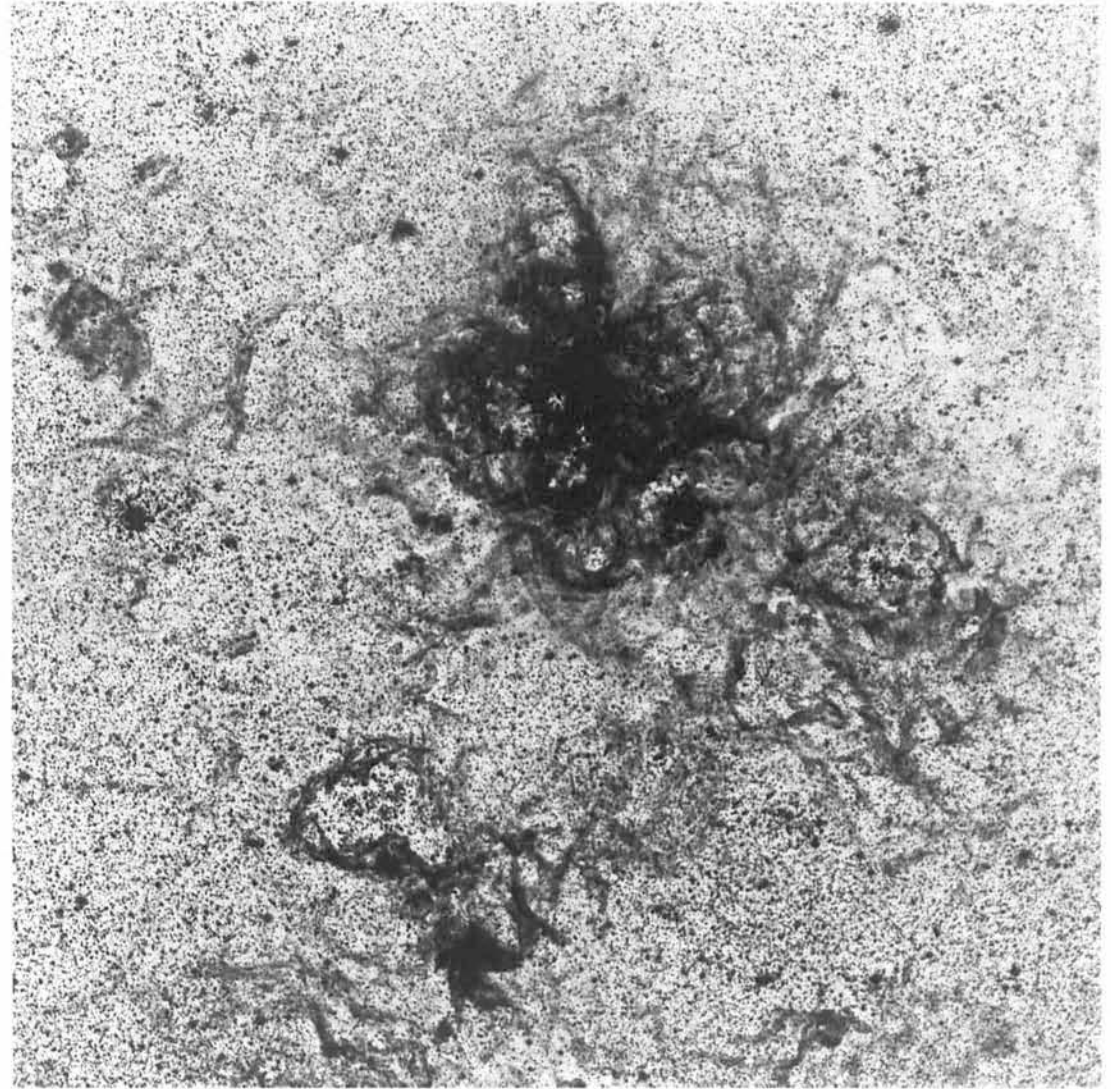

59 The north-west part of Plate 58 is here reproduced at a lower density in order to show the immediate surroundings of 30 Doradus. Even very faint nebulous filaments are visible here, and the great complexity of this area is evident. Compare this photo with Plate 56.



60 A closer look with a large telescope at a small section of the LMC bar. A comparison of this with the Schmidt exposure on Plate 51 may be useful. The field can be identified by means of the two clusters NGC 1898 and NGC 1913, which in this picture are situated at the lower right edge, and halfway between centre and upper left edge, respectively.

The faintest stars visible here are somewhat more luminous than our Sun, which means that in spite of the crowding of stars, only the brighter ones in the galaxy have in fact been recorded. Modern detectors allow us to go somewhat deeper and to see stars slightly less luminous than our Sun. But it would certainly be valuable to go considerably deeper in order to make detailed studies of the low luminosity stars, which are low mass stars of an old stellar population. A comparison of this with the population of stars in the solar neighbourhood would be most fruitful. This type of work requires, however, a much larger telescope like the projected VLT (see page 253). It requires the large light collecting power of the VLT and in addition, as one can see on the Plate, a very good resolution, in order to separate the many faint stars that will emerge among the bright ones seen here. This illustrates the hard requirements on atmospheric seeing. Of all good places in the southern hemisphere the one with the very best seeing should be chosen as the site for the VLT.

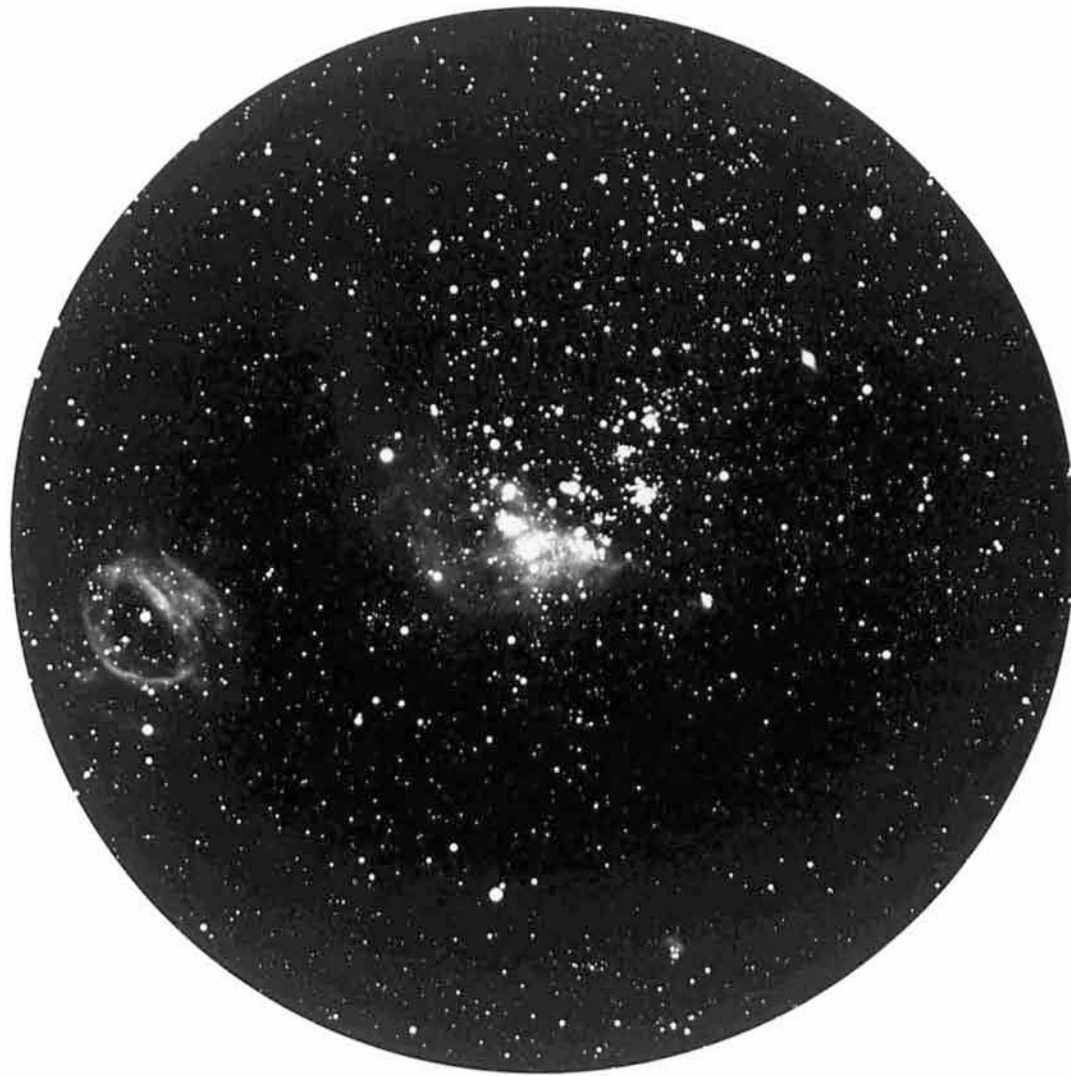

61 This LMC field is far from the bar, north of the field shown on Plate 51. But even this far out we find clusters (e.g. NGC 2014 near the centre), and nebulosities (e.g. the ring-shaped NGC 2020, near the eastern edge). The density of stars in this area is clearly much lower than in or near the bar.

Plate 61

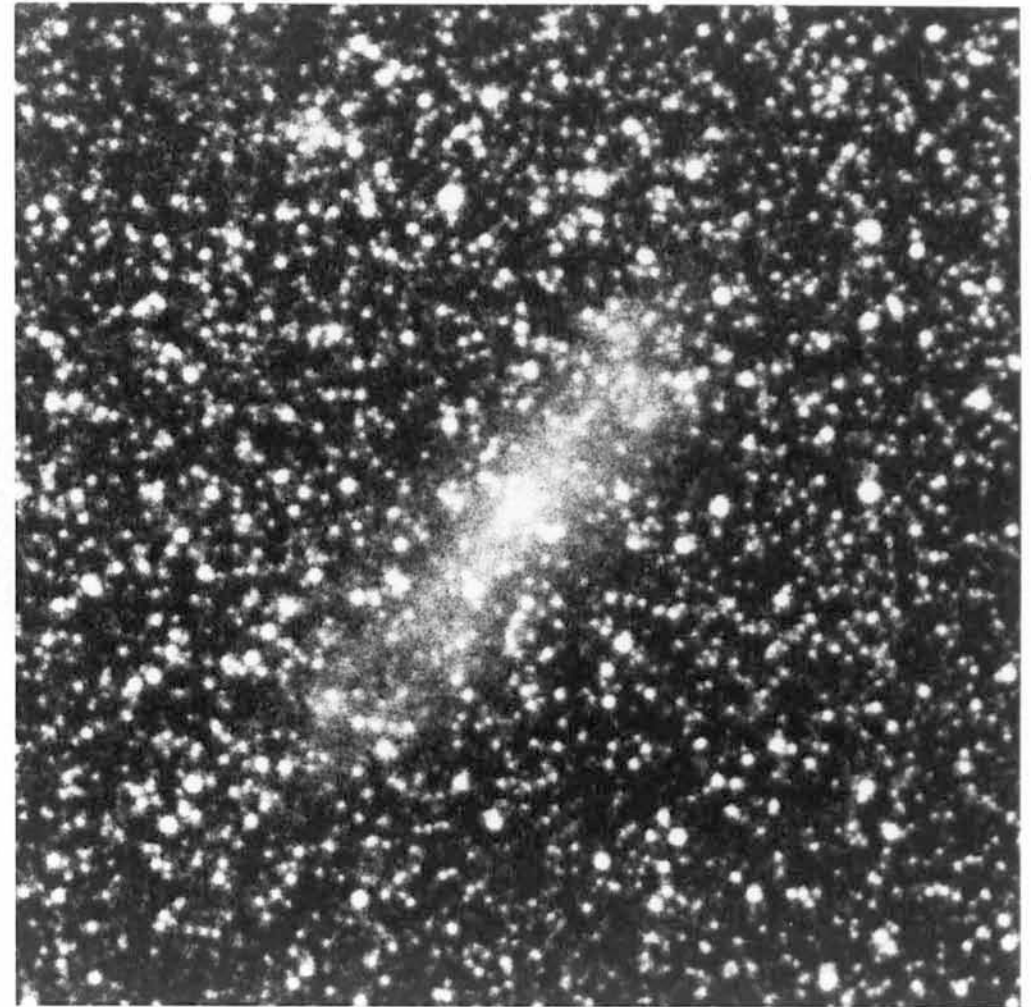

62 NGC 1809 is one of the many nebulae that are seen in the dense stellar fields near the LMC bar. It has been known for more than a century, and for a long time was believed to belong to the LMC. However, less than a decade ago, it became possible to measure the radial velocity of the bright spot near the centre of NGC 1809. Somewhat unexpectedly, the velocity was found to be 1000 km/s, or several times larger than the velocities of stars and other LMC nebulae.

Plate 62

Clearly, NGC 1809 does not belong to the LMC; it is a background, spiral galaxy at a distance of about 50 million light-years. The bright spot is its nucleus. It is interesting to note that the LMC is therefore quite transparent, despite the large number of stars in this field. Thus, there cannot be much obscuring dust in the LMC.

63 In his catalogue of emission nebulae in the LMC, Henize gave this one the number 70. It is rather faint, indeed it is one of the faintest nebulae visible on Plate 51. In this enlargement, N 70 presents itself as a pretty, circular nebula. Closer inspection shows that, in space, it has a "shell" structure and is a *bubble* of nearly spherical shape. It would therefore appear to be a typical interstellar remnant of a supernova explosion (see also Plate 138). However, recent X-ray, optical and radio observations have led to quite a different explanation.

The cluster of stars close to the centre of N 70 is a region of star formation, towards which the surrounding neutral hydrogen gas will tend to fall. On the other hand, a few of the stars born in this region have developed "stellar winds", where atomic particles are continuously blown outwards. Hot stars of the Wolf-Rayet type are particularly active in this respect. They eject a stream of particles into surrounding space with velocities of several thousand kilometres per second. This outflowing stream from the hot stars

in the cluster collides with the infalling hydrogen just mentioned. After some time, a state of equilibrium is established in a shell between the infalling neutral gas and the outflowing charged particles. Within the confines of this shell, neutral hydrogen atoms will become ionized and thereby emit red light of the H_α line, which is that seen in the picture.



64 The Small *Magellanic Cloud* is our second nearest, extragalactic neighbour in space. It lies at a distance of 250 000 light-years. From this we can conclude that not only are the LMC and SMC seen near each other in the sky, but that they are also close neighbours in space, with a distance between them of only 90 000 light-years. Undoubtedly the two Clouds must in some way or other have a common origin, and their history, or at least their recent evolution, must be linked to that of our Galaxy. Much research has gone into this and related questions.

A band of neutral hydrogen, known as the *Magellanic Stream*, was detected with radio telescopes a little more than a decade ago. It covers a large arc of the sky, and passes through both the LMC and the SMC. This is another strong indication of a common history. But in spite of great observational efforts, the origin of the Magellanic Stream is still not properly known.

The Small Magellanic Cloud is an irregular galaxy, classified as Im. It is less massive and 4 times less luminous than the LMC. Otherwise the general characteristics of the two are not much different; their contents of stars, clusters and nebulae appear to be quite similar. More detailed studies, however, have revealed important differences between the two Clouds, and between them and our Galaxy. Both Clouds contain a higher percentage of neutral hydrogen and both have a smaller content of heavy elements than has the Milky Way Galaxy. In both respects the Small Cloud deviates the most from what we call the "standard conditions" prevailing in the solar neighbourhood. This has to do with the different ages and with the fact that the pro-

cess of star formation is not equally efficient in the three galaxies. Most of the stars in the LMC and SMC are believed to be considerably younger than those of the Milky Way Galaxy, probably only half as old. And both Clouds, but especially the SMC, have been slower than the Galaxy in making stars from interstellar clouds.

Observations have shown that the SMC is remarkably deep when compared with its extent in the sky. Radio observations of the 21-cm

wavelength emission of neutral hydrogen in the SMC have revealed the existence of distinct components with a difference in radial velocity of 30 km/s. This has led to the suggestion that the SMC is perhaps not one but two galaxies, seen in the same direction in the sky, one of which is 20 000 light-years behind the other. Some astronomers think that the SMC was torn apart during a near-collision with the LMC some 20 million years ago.

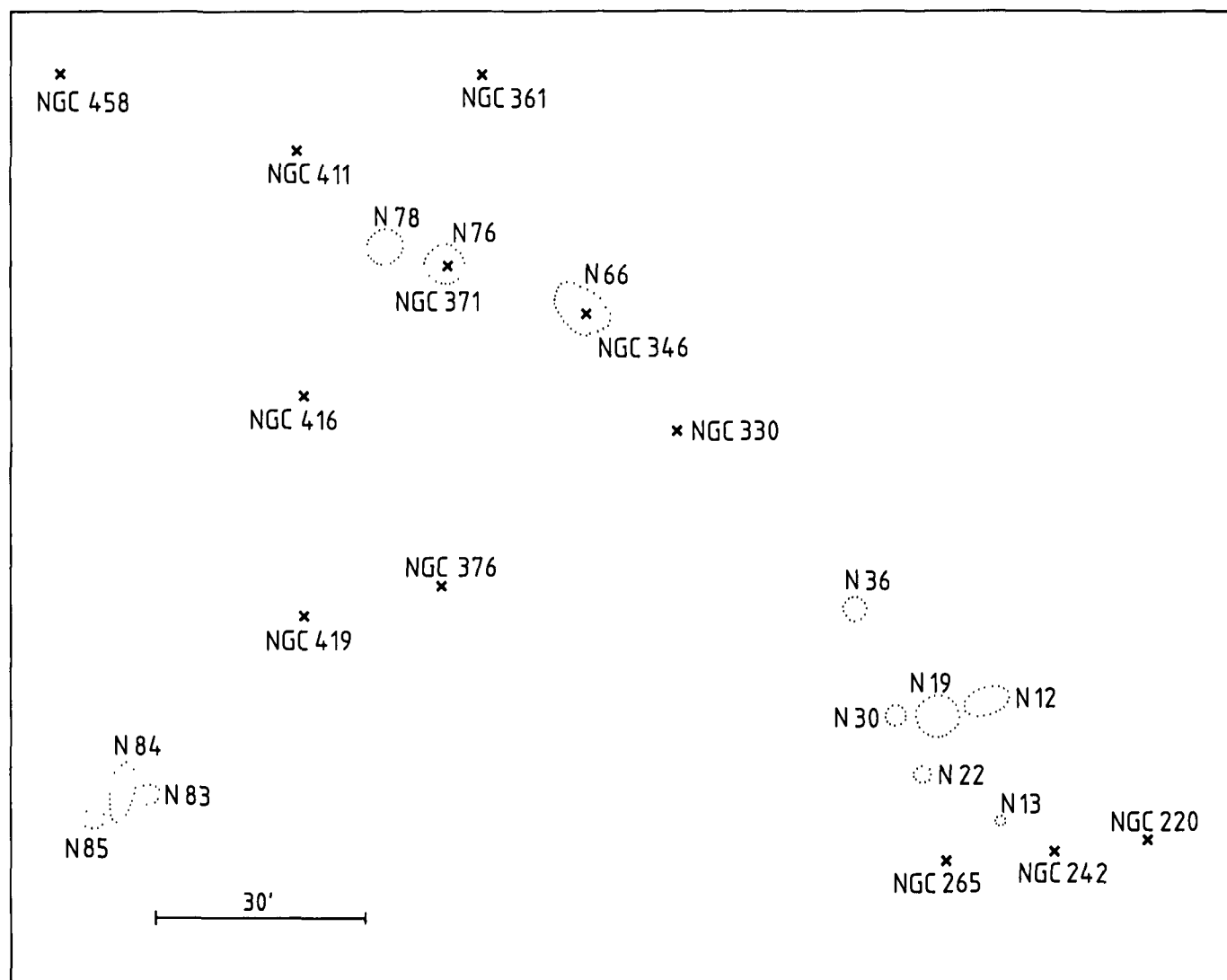





65 A closer look at a dense area of the SMC with a star cluster, north of centre, and a small emission nebula, south-east of the centre. It is not a very deep view since the exposure time was limited to 15 minutes. All stars in the Cloud that are visible here exceed the luminosity of the Sun by a factor of 5 or more. The great majority of stars in the SMC are fainter and can therefore not be seen in this picture.

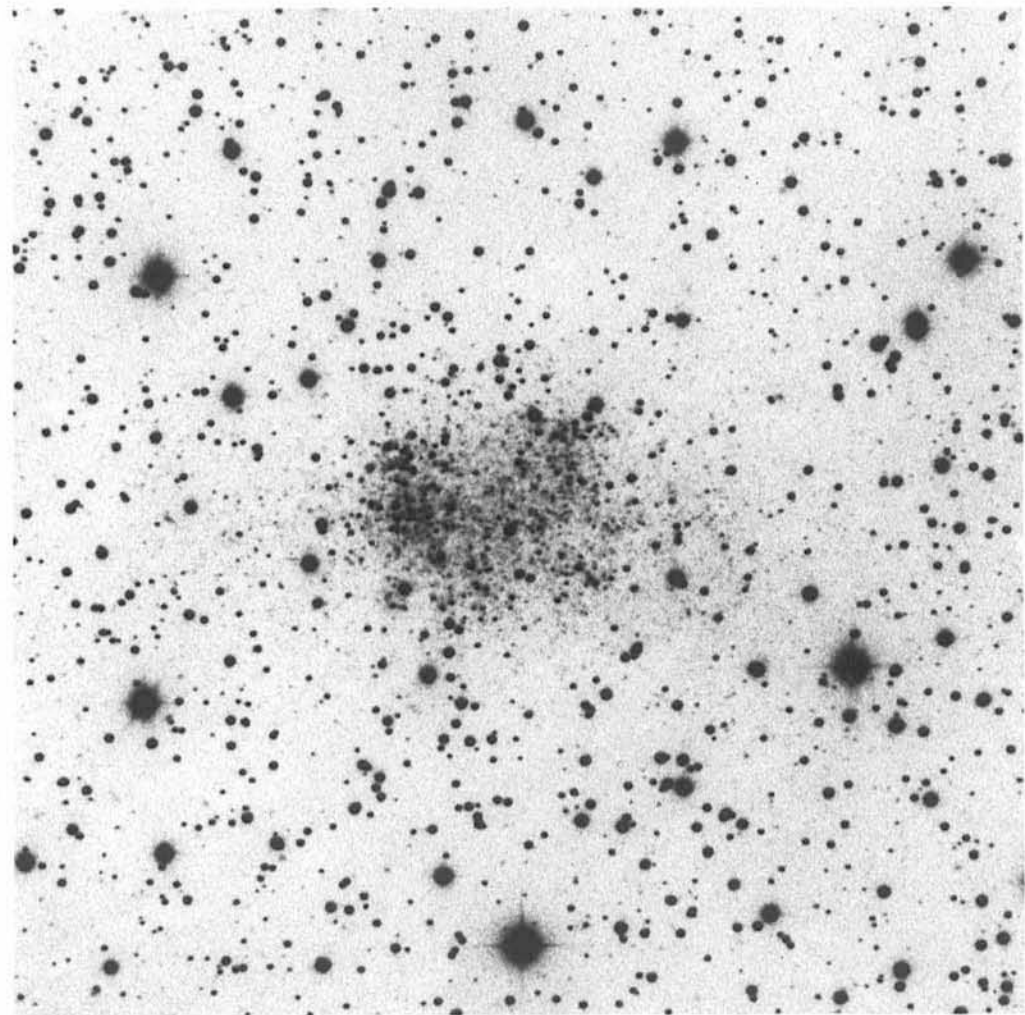

66 This object, SagDIG (Sagittarius Dwarf Irregular Galaxy), is a dwarf Im galaxy that was detected in 1976 as a diffuse spot on an ESO Schmidt plate. This 90-minute exposure with a large telescope shows the irregular shape of SagDIG with more than one hundred blue stars resolved. It is a true dwarf galaxy as no less than 10000 objects of its size could be fitted into the space occupied by a single spiral galaxy like our

own. SagDIG is situated $4^{\circ}6'$ away from NGC 6822 (Plate 67) in the sky. If SagDIG is at the same distance from us as NGC 6822, about 2 million light-years, then the distance between the two is around 160000 light-years.

67 This is not a conventional photo, but an *electronographic* exposure of the Im galaxy NGC 6822, situated on the outskirts of the Local Group. In the electronographic camera, a photocathode replaces the photographic plate in the image plane of the telescope. Each incoming photon that is detected by the cathode liberates a few electrons. These electrons are accelerated and re-imaged onto a nuclear emulsion by a system of electric and magnetic fields. The present picture is an enlarged print made from the nuclear track emulsion film. The electronographic method has important advantages for use in astronomy. Compared with the photographic technique, it has better sensitivity and can therefore show fainter objects. Because of lower contrast, however, it produces less impressive pictures. Note the two bright emission nebulae in this galaxy (at the top of the picture).





68 The Sculptor Dwarf Elliptical Galaxy. In 1938, the American astronomer Harlow Shapley (1885–1972) detected a peculiar cloud of extremely faint stars on deep photographs in the constellation Sculptor. This area is close to the galactic South Pole, where the Milky Way's foreground stars are relatively scarce, a fact that made it easier for Shapley to see the cloud. Further studies of the individual stars in the cloud showed that the distance was very great, 260 000 light-years, and that the total diameter was about 8000 light-years. It was therefore an extragalactic star cloud at about the same distance as the SMC – in other words a galaxy of a new type, not represented in the Hubble sequence. The galaxy is similar to elliptical galaxies in several respects, such as stellar content and shape. It was therefore called a *dwarf elliptical* (dE) or *dwarf spheroidal* galaxy. Since the Sculptor dE galaxy is somewhat flattened, it is classified dE3.

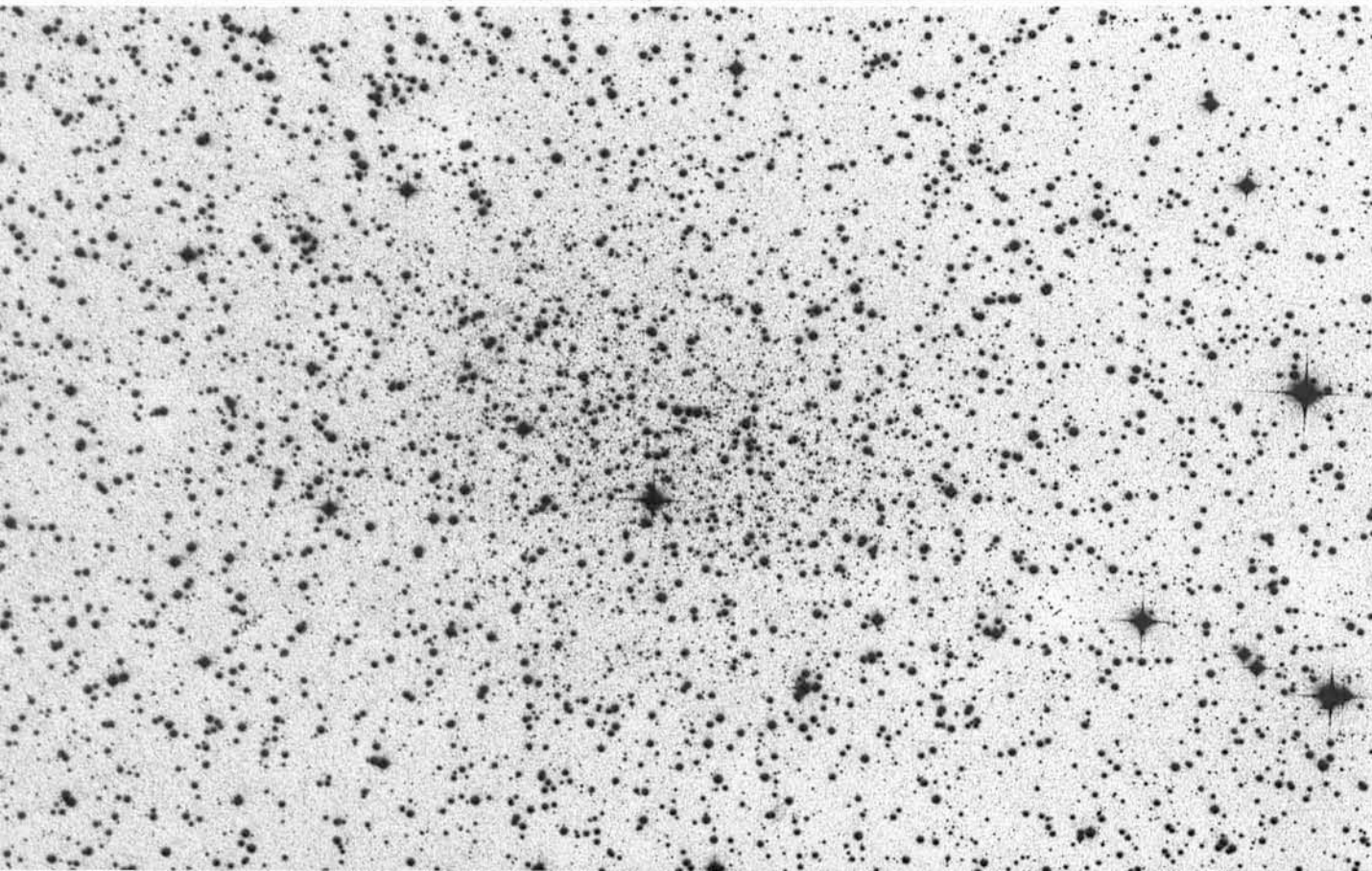

In other respects dE galaxies are significantly different from E galaxies. Their stellar density is much smaller, so small in fact that remote galaxies can be seen right through them. Even at their centres, the stellar density is at least 1000 times smaller than that in the solar neighbourhood.

69 The Carina dE galaxy. Most dwarf elliptical galaxies that have so far been found near our Galaxy are situated at high galactic latitudes. However, this one in the constellation of Carina lies at galactic latitude -22° , in a field where the density of foreground, Milky-Way stars is high. The difficulty in detecting the object is clearly demonstrated in the photo; as a matter of fact it was only found in 1974, on very deep Schmidt plates obtained in Australia. It is the smallest of all known dE galaxies, and its mass and luminosity are one million times smaller than those of the Milky Way Galaxy.

70 The Fornax dE galaxy is the largest dwarf spheroidal galaxy known. It belongs to the Local Group of Galaxies, although it is situated in the same constellation as the more distant Fornax cluster of galaxies. The Fornax Dwarf Galaxy is the only one of its type in which globular clusters have so far been detected. Three such clusters are seen in the photo. A total of seven dwarf spheroidals are now known in the Local Group. All are within a distance of 700 000 light-years, and, like the Magellanic Clouds, they are considered to be satellite galaxies of the Milky Way Galaxy.

The origin of these dwarfs is undoubtedly connected with the early history of the Milky Way Galaxy. The huge cloud of hydrogen and helium, which some 13–18 billion years ago condensed to form our Galaxy, was not uniform, but fragmented into smaller clouds. Some fragments may have developed into globular clusters, while others at the edges of the cloud may have become the dwarf spheroidal galaxies, of which some, possibly only a small fraction, still remain intact today. The formation of stars in these dwarf galaxies started early, and apparently stopped after a short period. They contain only a single generation of very old stars. A current hypothesis is that this early generation of stars developed a few supernovae that were able to blow all the remaining gas and dust out of these small galaxies. And with no more gas and dust there was no more star formation. The same thing will not happen in larger, massive galaxies because they contain much more gas and dust, which is securely bound by their much stronger gravitational field.

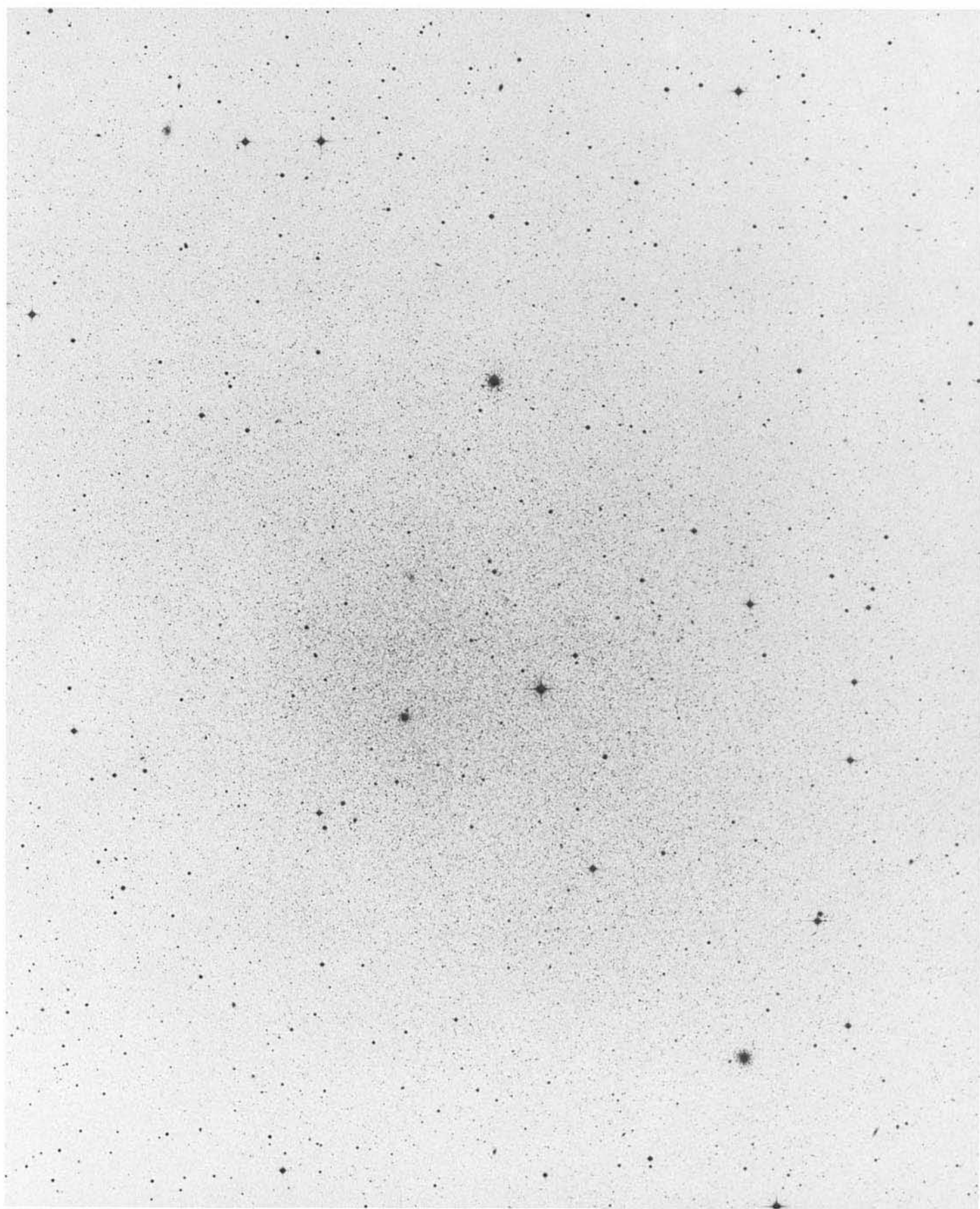



1.4 The Sculptor Group

The *Sculptor Group*, at a distance of 10 million light-years, is the nearest group of galaxies outside the Local Group. Most of its galaxies are located in the constellation of Sculptor, hence the name. It is sometimes called the South Polar Group, since the direction in which it is seen is close to the galactic South Pole. It is a loose group of a few galaxies, and its total mass is only about half that of the Local Group. All its galaxies are of late type: Sc, Sd and irregular. Since it is so close to us in space, it is not very likely that more galaxies belonging to this group will be found, although some very faint dwarfs of the spheroidal type may still be detected when larger and more powerful telescopes become available.

71 NGC 300 is a pretty Sc galaxy in the Sculptor Group, very similar in appearance to the Local Group galaxy M 33 in the northern sky. It has a small nucleus and a faint, reddish nuclear bulge, as can be seen in this colour photo. Most of the galaxy appears blue, because of a high content of young, hot stars. In fact the more luminous of these stars, due to the moderate distance of NGC 300, are bright enough to be resolved in the photo, and they can be seen as individual stars that are blue in colour.

A fair number of red H II regions are present in NGC 300. They appear to be distributed randomly, and they are not lined up along the spiral arms as was the case in the galaxy M 83 (Plate 48). Like other high-quality colour prints, this one was made as a composite of three black-and-white plates, one exposed to red, one to green, and one to blue light. During the red exposure an artificial satellite accidentally crossed the field. We see its trail as a red, straight line running nearly north-south.



72 In this photo of NGC 300 we can clearly recognize the S-shape of the inner part of the spiral structure. Its outer parts are fainter and more irregular. An overall asymmetry will be no-

ticed, since the northeastern part of the galaxy is clearly brighter and more extended than the southwestern part.

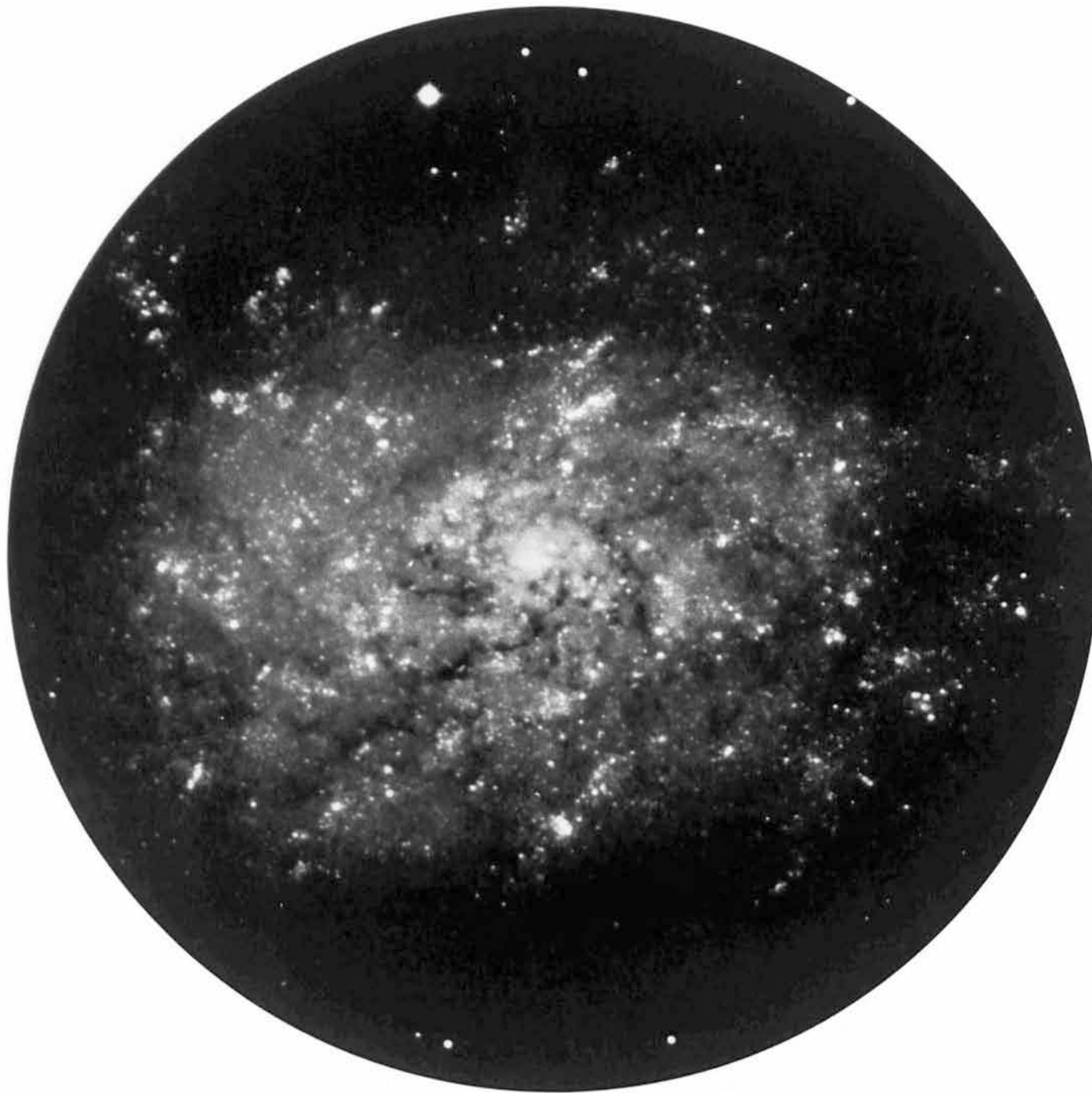

73 NGC 7793 is an Sd galaxy, and it is a splendid representative of its class. It has a small central region and a chaotic spiral pattern. The im-

age gives a general impression of spiral structure, but it is hard to identify spiral arms of any great length. In this respect it differs markedly from

galaxies like NGC 1365 (Plates 4 and 5), and NGC 2997 (Plates 33 and 34), where two or more extended spiral arms define a clear, spiral pattern.

Two different models for star formation, and thereby for the formation of spiral structure, have proved to be necessary in order to explain the variety of spiral patterns seen in galaxies.

A *global spiral pattern* is explained by a “density-wave” theory in which the spiral arms are simply regions of space where the density is momentarily higher. The process is similar to waves in water; the individual water molecules move back and forth, but stay more or less in the same place.

A *chaotic spiral pattern* is explained in a different way by a model for star formation, which can be described, in short, as follows: First a number of stars are born in a dense cloud. Star formation, however, is an inefficient process that uses up only a few per cent of the total mass of gas and dust in the cloud. The hottest young stars tear the remaining gas cloud to pieces by strong radiation and stellar winds, and push it out into the surroundings. Here the gas collides with other clouds, and new areas are created with densities high enough for star formation. In this way the region of star formation propagates through the galactic disk over a distance of a few hundred light-years, and the result is a row or chain of young stars. Due to the differential rotation of the galaxy (the inner parts rotate faster than the outer), the chain stretches and eventually forms a small segment of a spiral arm. The different chains originally have very different forms and orientations, but since the rotation of the galaxy tends to turn all of them the same way, the end result of any star-formation pattern will be a spiral-like structure.

74 NGC 253 is an Sc galaxy seen at a steep angle of inclination, almost edge-on. The upper, right-hand edge is the one nearest to us; this



can be deduced from the appearance of the absorption by dust clouds in the disk of the galaxy. It is the largest galaxy in the Sculptor Group, and when observed with infrared-sensitive equipment it is one of the brightest galaxies in the sky. The source of infrared radiation is in the nucleus, and a considerable flow of high-velocity gas out of the nuclear region has been detected. The strong, infrared radiation as well as the gas outflow may possibly be due to a recent, strong burst of star formation in the nuclear region.

Studies have led to the discovery of a large optical halo around NGC 253. It consists of stars; but recently detected, strong radio emission from the halo proves that there must also be a great deal of gas in this halo.

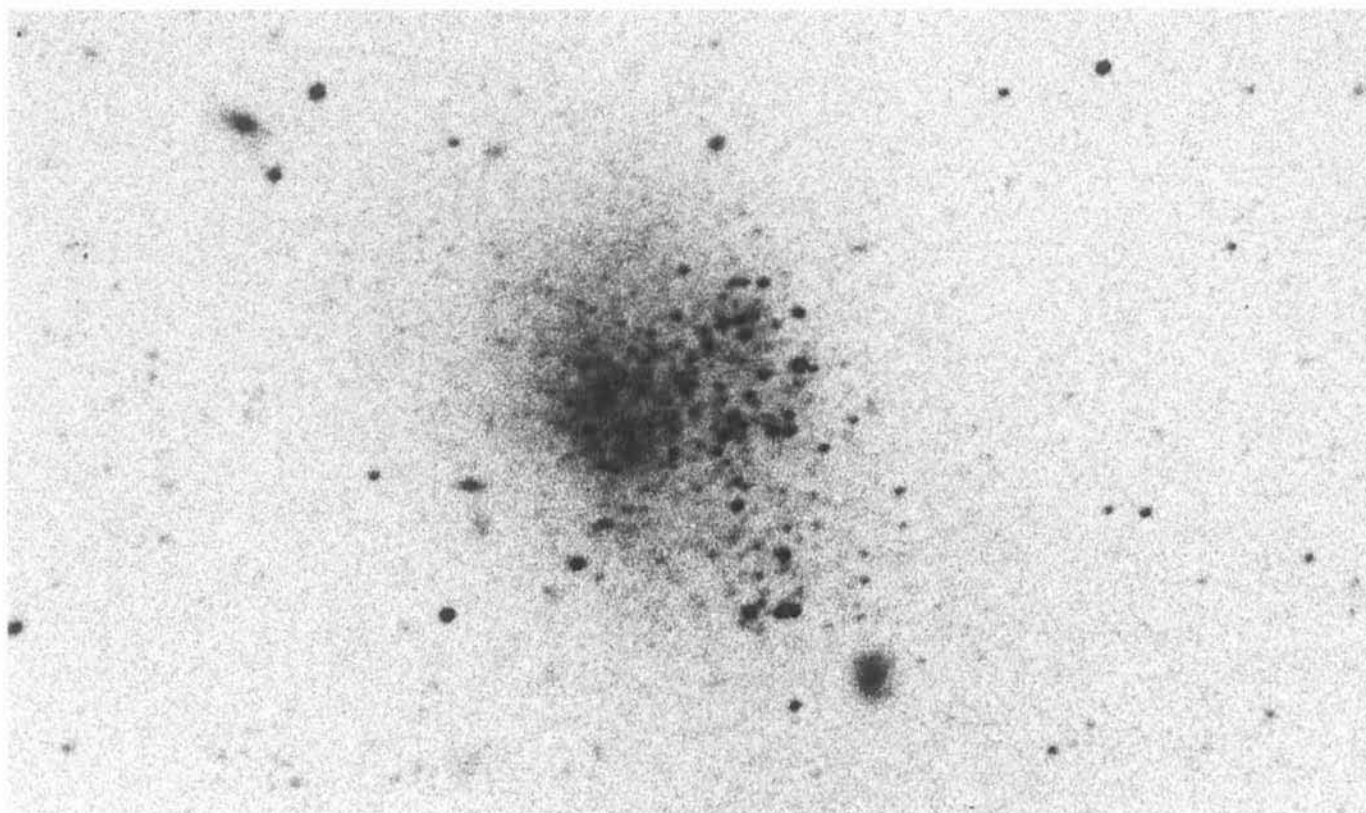

75 The Sculptor Dwarf Irregular Galaxy (SDIG) is a dwarf irregular of the Magellanic type, dIm, which was detected and first studied by ESO astronomers in 1976. It is seen in front of a rich cluster of much more distant galaxies. The bright stars in SDIG, of which a large number are resolved here, are young and blue. This tiny galaxy also contains a few, red-giant stars, which have enabled a determination of its distance. This in turn confirmed its membership of the Sculptor Group of galaxies. Radio observations show a relatively high gas content for this galaxy. The presence of hot blue stars and gas indicates that SDIG is a site of continuing star formation.

76 In this colour photo of NGC 55 in the Sculptor Group, the difference between the red central part and the blue disk is clearly seen. The nuclear region is overexposed and therefore white. Individual stars and nebulae are clearly visible. NGC 55 is seen nearly edge-on and it is difficult to spot spiral arms in the disk. This galaxy has been classified as Sc, although some astronomers prefer to call it an irregular galaxy of the Magellanic type.



77 This Sculptor Group member, NGC 247, is a low-surface-brightness, Sc spiral galaxy with an extremely small central component. Its spiral structure is irregular and asymmetric.

1.5 Multiple Galaxies

In the world of galaxies, double and triple systems are fairly common, and even quartets, quintets and sextets are not so rare. It is obvious that since there are so many galaxies in the sky, it will often happen that two or more galaxies are seen in almost the same direction, although their distances may be very different. However, detailed studies have shown that most pairs and multiples of galaxies that are seen close together in the sky, and which have similar apparent magnitudes, are indeed physically bound together, or at least interacting through gravitational forces. In many cases the effects of gravitation can be seen directly, in the form of long tails or bridges of luminous material between the galaxies, and distorted shapes of one or more of the components.

Another, more indirect way to judge whether or not a pair of galaxies is physically connected is by measuring their radial velocities (see Plate 6). Distances of individual galaxies outside our Local Group are approximately proportional to their radial velocities. This means that galaxies that are seen close together in the sky, and which have approximately the same radial velocities, are near each other in space and are therefore likely to form a physical pair, in which mutual gravitation plays a role.



78 NGC 6769-71 is a magnificent triple system, far south in the constellation of Pavo (the Peacock). The two uppermost galaxies, NGC 6769 (to the right) and NGC 6770, are of nearly the same magnitude, whereas NGC 6771 (below) is slightly fainter. All three have large nuclear bulges of about the same brightness. The nuclear bulge of NGC 6771 is noteworthy for its peanut-like shape. About one per cent of all spiral galaxies have peanut- or box-shaped bulges; it has been found that such peculiar shapes can be produced if the bulge is rotating like a cylinder.

NGC 6769 is an Sb galaxy with a faint inner ring and tightly wound arms. NGC 6770 is of type Sb or SBb, with two main arms, of which one has a normal spiral shape, while the other is straight and points towards the outer disk of NGC 6769. Other peculiar features of NGC 6770 are the two faint arms, or rather arcs, which curve south towards NGC 6771, and there is also a straight line of absorption north of the centre. All these peculiarities indicate the presence of gravitational interaction between the three galaxies.



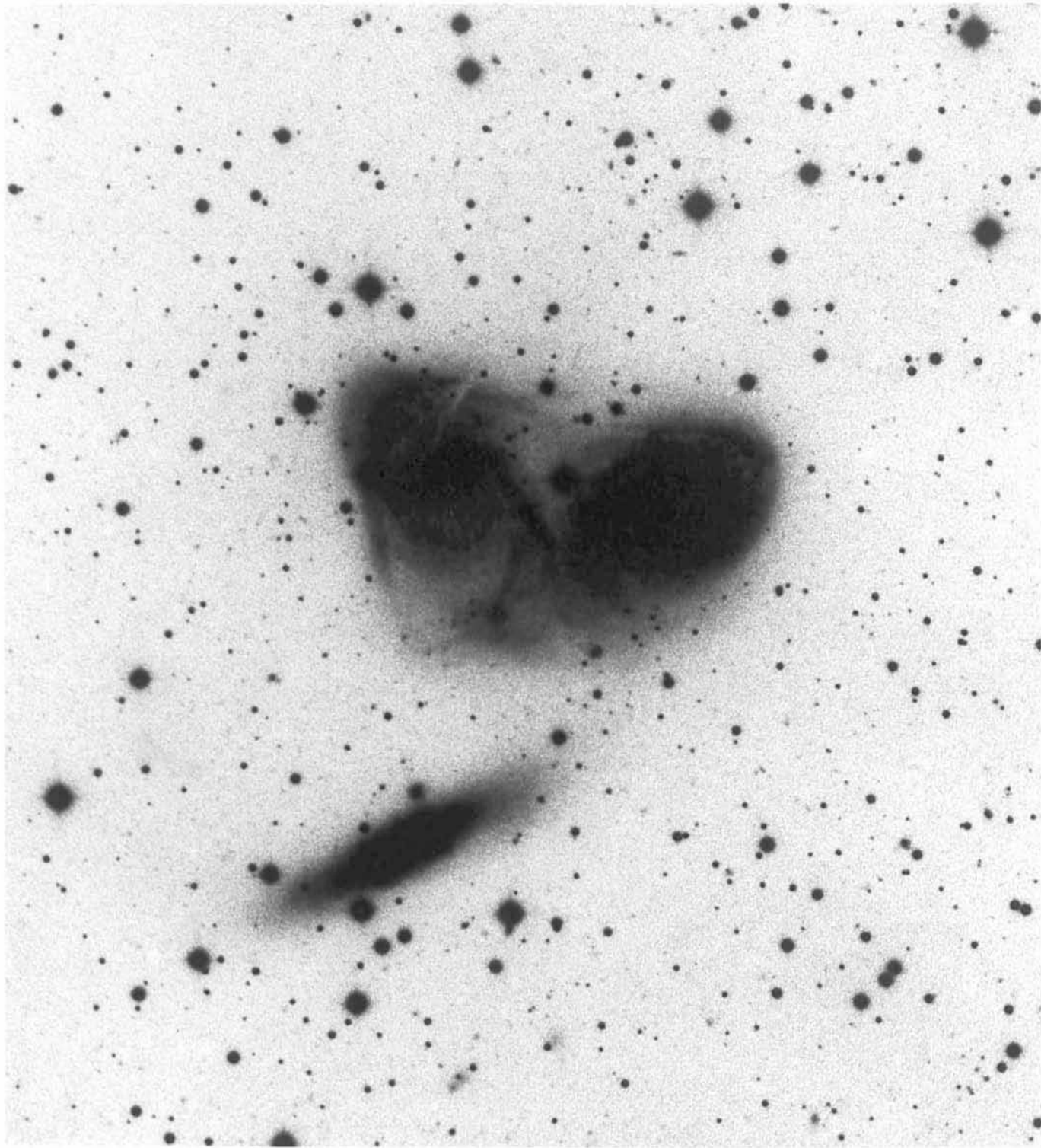

79 This enhanced photo gives further evidence of a physical connection between the galaxies NGC 6769, NGC 6770 and NGC 6771. It shows that NGC 6769 and NGC 6770 are inside a common envelope and there are traces of a bridge between NGC 6769 and NGC 6771.

The radial velocities of NGC 6769 and NGC 6770 are very nearly the same, while that of NGC 6771 is somewhat larger. There is no doubt that NGC 6769 and NGC 6770 form a physical pair, and it is most likely that NGC 6771 also belongs to the system. Its higher velocity may be a result of the gravitational pull of the two others. The triple system is at a distance of 190 million light-years.



80 NGC 5426-27 is a pair of two Sbc galaxies with small nuclear bulges. They are connected by a faint lane of luminous matter, which forms a bridge from one spiral pattern to the other. These two galaxies have about equal radial velocities and are situated at a distance of 125 million light-years.

As mentioned earlier (Plate 16), spiral galaxies rotate around an axis perpendicular to the disk. The spiral arms lie in the disk and normally the direction of rotation is such that the arms are trailing. This means that both galaxies seen here should have a clockwise rotation. Radial velocity measurements of the lower galaxy, NGC 5426, show that the rotational motion is such that the northern side of the galaxy is approaching and the southern side is receding. For a clockwise rotation we therefore infer that the western side of the galaxy is the one nearest to us. Some astronomers, however, have looked carefully into this and suggested that the eastern side should be the near one. In that case, the rotation must be counter-clockwise, and exceptionally the arms must be leading instead of trailing. A few similar, as yet unresolved cases are known; all of these are components of multiple systems. It is not a proven fact that galaxies with leading spiral arms exist, but if they do exist the conditions under which they form may be found in multiple systems.

81 NGC 87-88-89-92, a quartet of rather different galaxies, is at a distance of 180 million light-years. They lie near the centre of the southern constellation of Phoenix. NGC 87 is an irregular galaxy of the Magellanic type, Im, and it is dotted with emission regions. In the western part these regions trace an arc, like a rudimentary spiral arm. NGC 88 is a spiral galaxy with an outer, diffuse envelope, probably of gas. NGC 89 is an Sa galaxy with two very dominant, broad arms. The largest member of the quartet, NGC 92, is of type Sa, and has a very peculiar feature. One arm extends towards the south-east; its length is about 100000 light-years. This enormous arm has been disrupted by gravitational forces, and it contains a large amount of dust, especially where it is attached to the main body.

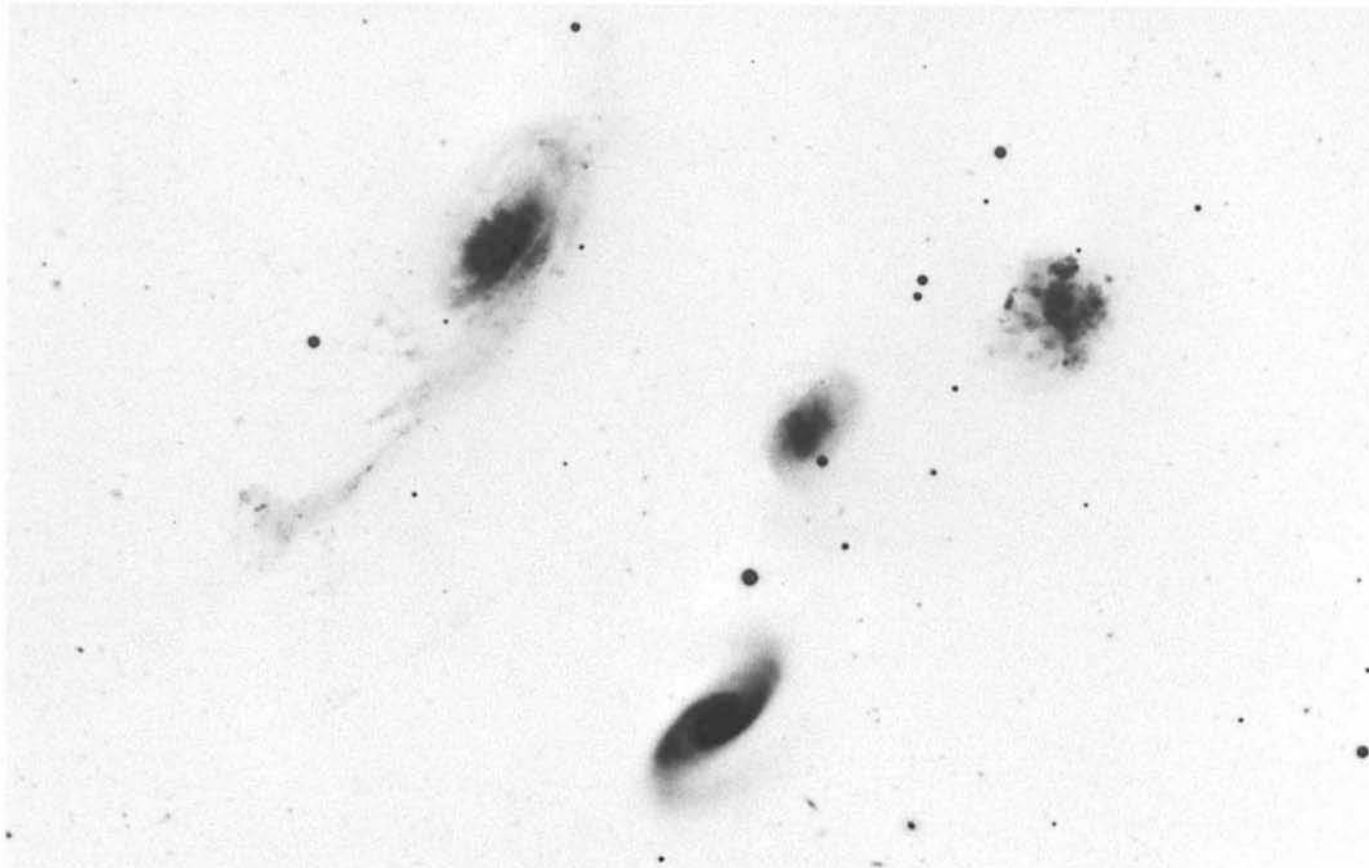

82 ESO 137-IG 44 is a double galaxy at a distance of 230 million light-years. It is possible that they form a triple system with the galaxy to the west, but this has not yet been observationally proved. The third galaxy has no designation and its radial velocity has not yet been measured. All three galaxies are of early type, S0-Sa. The largest one appears to be surrounded by an extended envelope.



83 ESO 124-G 18 (right) is an SBa spiral galaxy and ESO 124-G 19 (left) is a spiral, probably Sab, galaxy. Observations have shown that they are at the same distance, about 320 million light-years away. They most probably form a gravitationally bound pair.

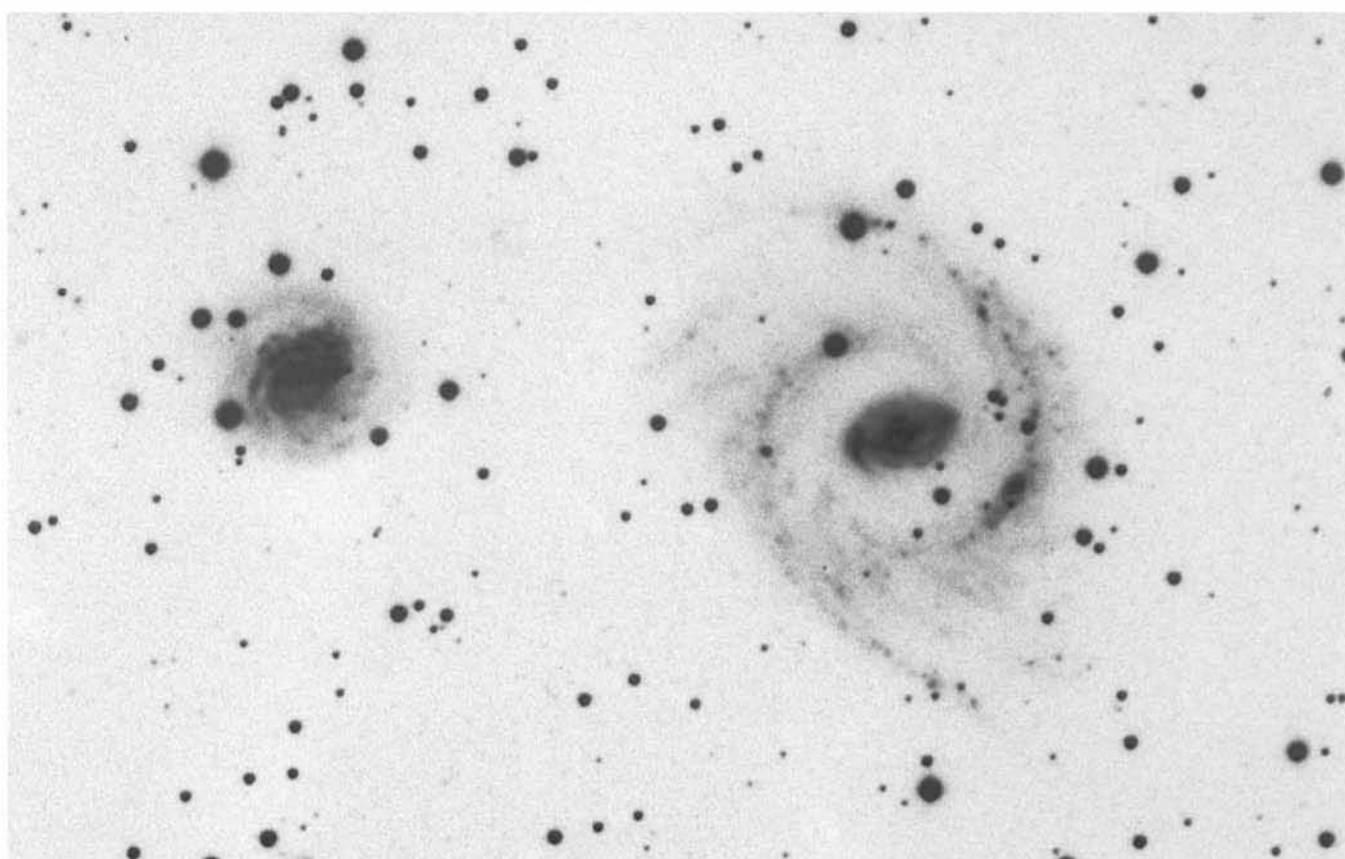

84 NGC 6438-38A: Based on the general appearance of these two galaxies, and because both are at a distance of about 110 million light-years, we conclude that they form a physical pair in space. An unequal couple, indeed! NGC 6438 (right) is an S0 galaxy with a barely visible disk, and NGC 6438A (left) is a monstrous thing, an irregular galaxy, or perhaps a late-type spiral galaxy that is distorted beyond recognition. It has a nucleus, and also a small disk from which two broad arms emerge. The northern arm is curved and forms a ring that is not quite closed. Within the ring, and south of it, there are many dark, absorbing clouds. It is altogether a very dusty galaxy. It is interesting that the arm on the side towards the S0 galaxy is better defined and has a sharp edge.



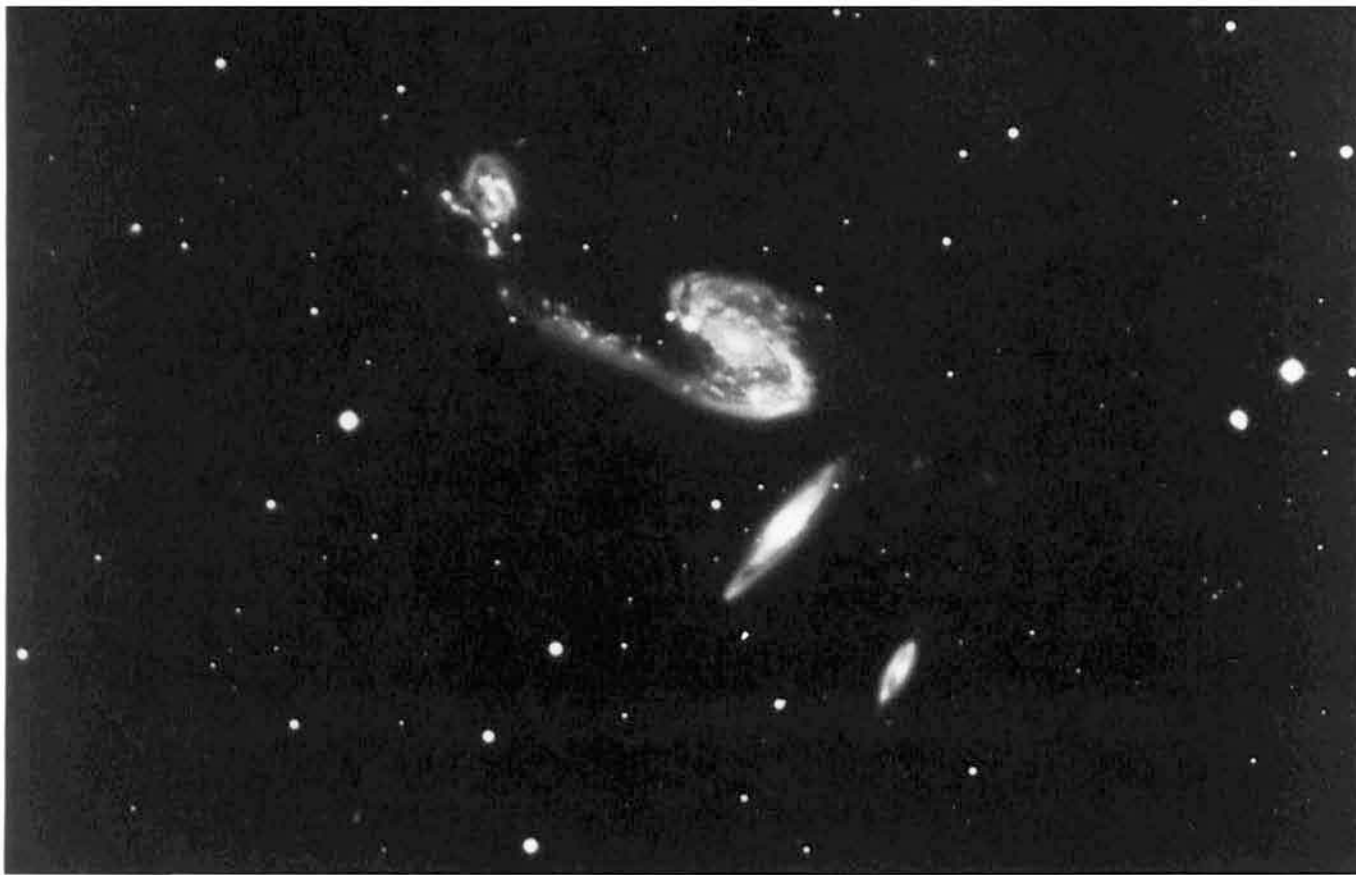

85 NGC 6845 is the large galaxy in this multiple system at a distance of 325 million light-years. An arm extends from it towards the smaller galaxy to the north-east; this arm is at least as long as that of NGC 92 (Plate 81). There is also a faint bridge (not visible here) that connects it to the nearby galaxy to the south-west. Although the radial velocities of the three galaxies differ by up to 600 km/s, there is little doubt that this is a real triple system. As to the fourth and smallest galaxy, we see no bridge, and no gravitational disturbance. Its radial velocity has not yet been measured, and we have therefore no basis for deciding whether or not it belongs to the system. All the galaxies are spirals, the two upper ones are of late type (Sc), whereas the two lower ones are of an early type (Sa).



86 ESO 161-IG 24 lies at a distance of nearly 500 million light-years. It is an Sc galaxy with very disturbed arms. At the end of a faint arm, a much smaller satellite galaxy seems to be attached. The radial velocity of the small galaxy is not yet known, but it is most likely a true satellite galaxy of the larger one.

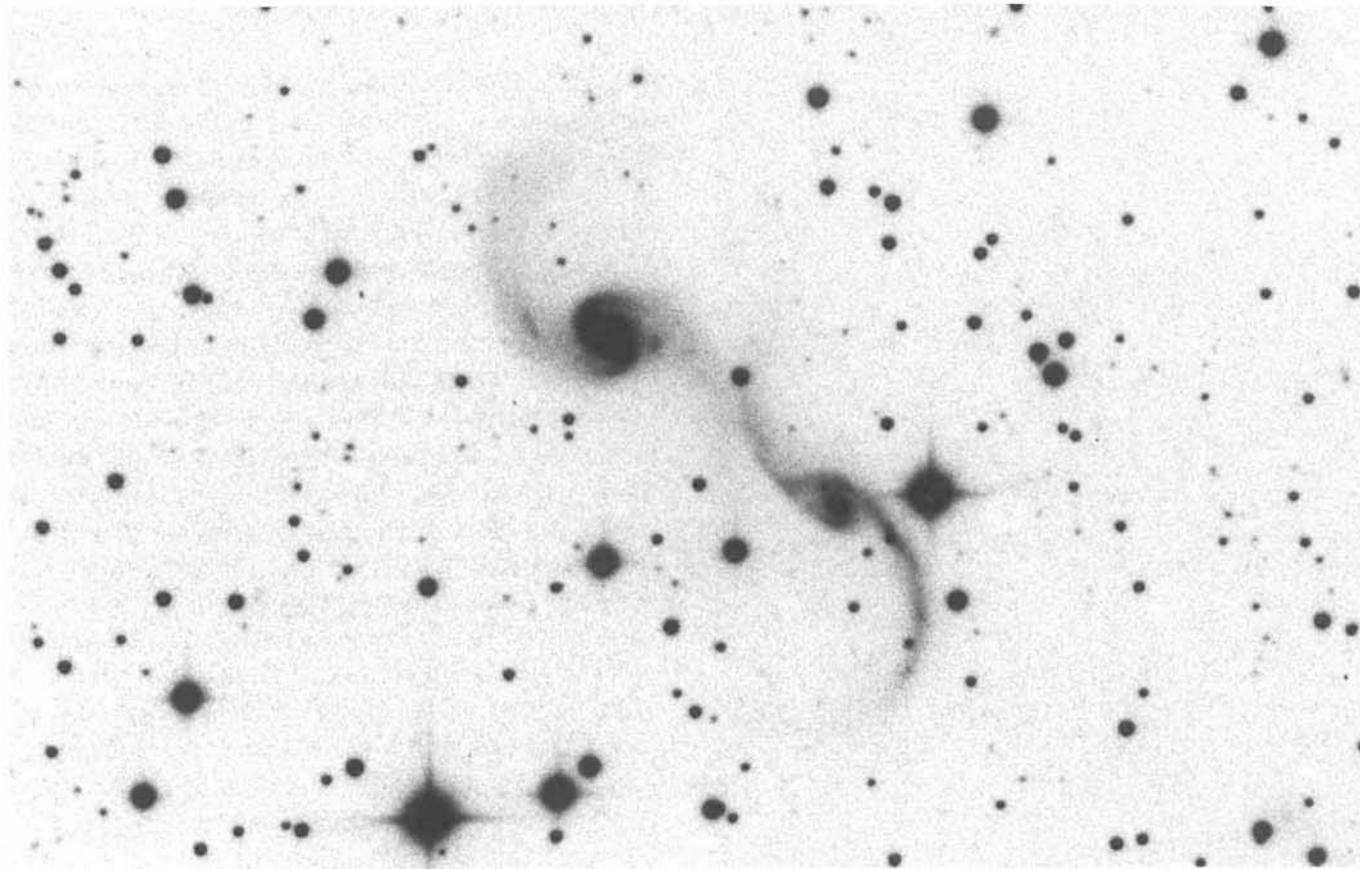

87 ESO 273-IG 04 is a distant pair (550 million light-years) with connecting arms. The projected separation of the two is 120000 light-years, somewhat less than the distance between the Milky Way Galaxy and the Large Magellanic Cloud. The larger galaxy is of the Seyfert type (see Plates 31 and 119) and has a bright nucleus.

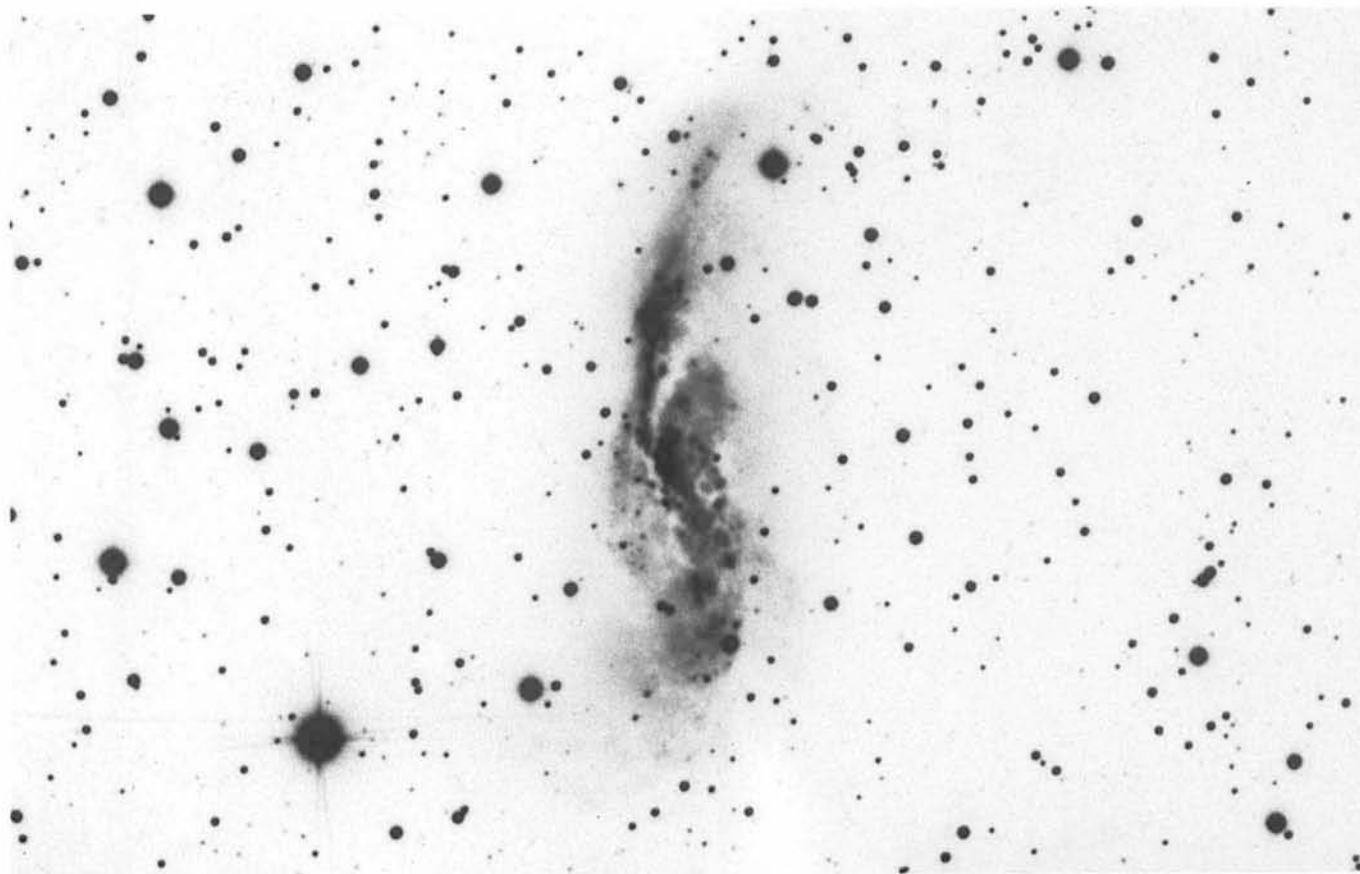

88 IC 2554 is a very disturbed pair of galaxies with a large number of emission nebulae, indicating high activity of star formation. The pair's radial velocity is moderate, 1100 km/s, which corresponds to a distance of 55 million light-years. A nearby galaxy, NGC 3136 B, is at a similar distance and may be partly responsible for the disturbances. It lies outside the field of this plate.

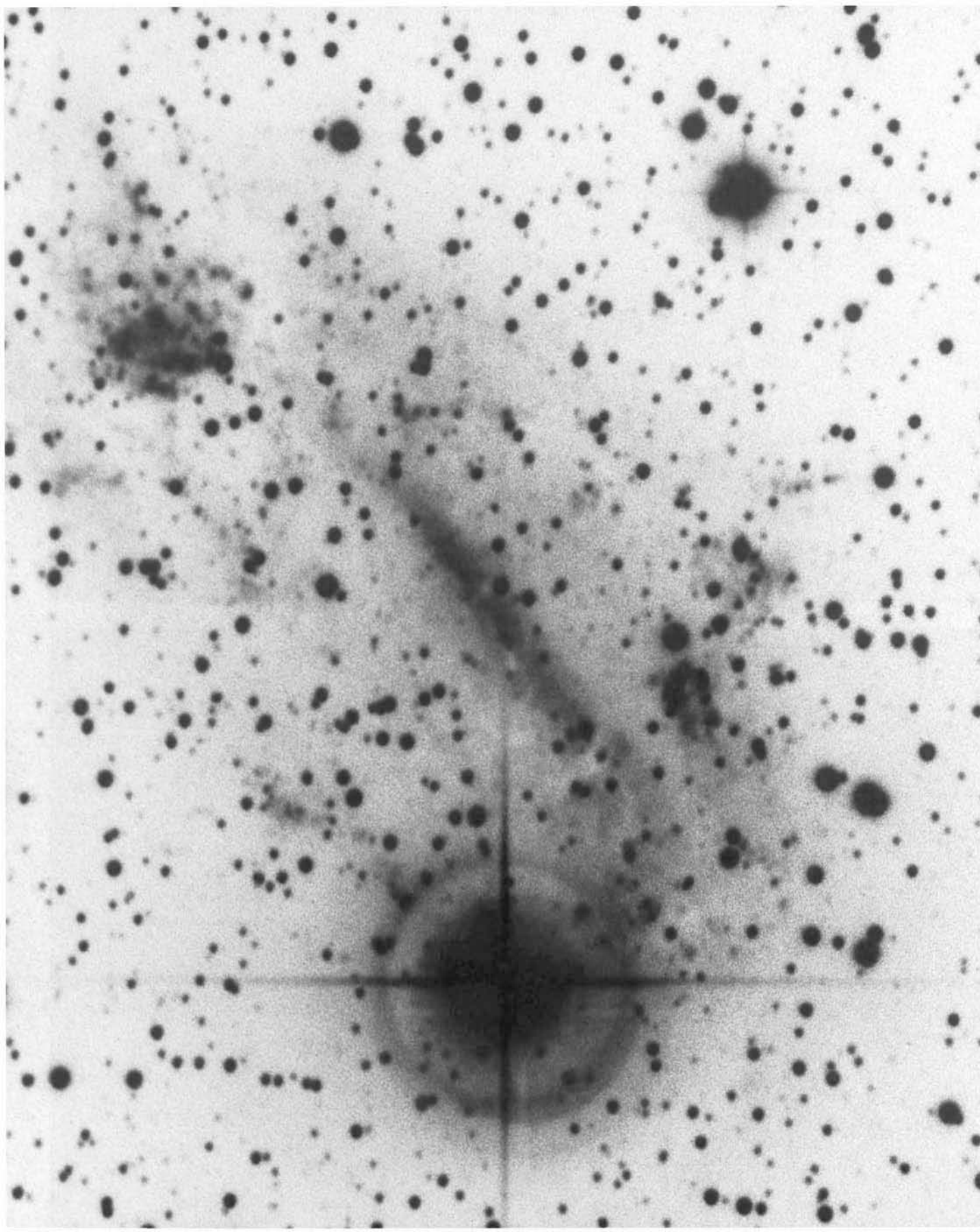

89 ESO 179-IG 13 is a strange system consisting of two very different galaxies. The one in the centre of the field has a bar-like, elongated structure, and the one to the northeast is a compact galaxy apparently with much star formation activity. A common envelope with a large number of separated clouds cover the area of the two galaxies. So far the system has not been well studied; a disturbing factor for future investigations is the 8th magnitude star in the foreground. The light from the star is spread over a large area. The cross is caused by the spider that carries the prime focus unit, and the ring is caused by reflections in the optical elements in front of the photographic plate.

90 This pair of galaxies, ESO 249-G 35 (right) and ESO 249-G 36 (left) belongs to a small cluster in the constellation of Horologium (the Clock), of which the brightest members are NGC 1493, NGC 1494 and NGC 1495. The distance is about 50 million light-years. Of the two galaxies seen here, G 36 is by far the most unusual. It is seen face-on and although it has a distinct spiral structure, the nucleus is extremely small. It is a very faint object and it must be rather thin, since we can see several, more distant galaxies right through it. The arms of G 36 are mainly defined by blue knots, which are groups of young stars. Its diameter is about 40000 light-years, so it is not a very large galaxy either. The classification is Sd. The other galaxy, G 35, is probably of the Sc type and it is seen edge-on.

All the tiny spots in this very deep picture are distant galaxies. Their large numbers lead us to believe that we are looking in the direction of a very distant, rich cluster of galaxies.

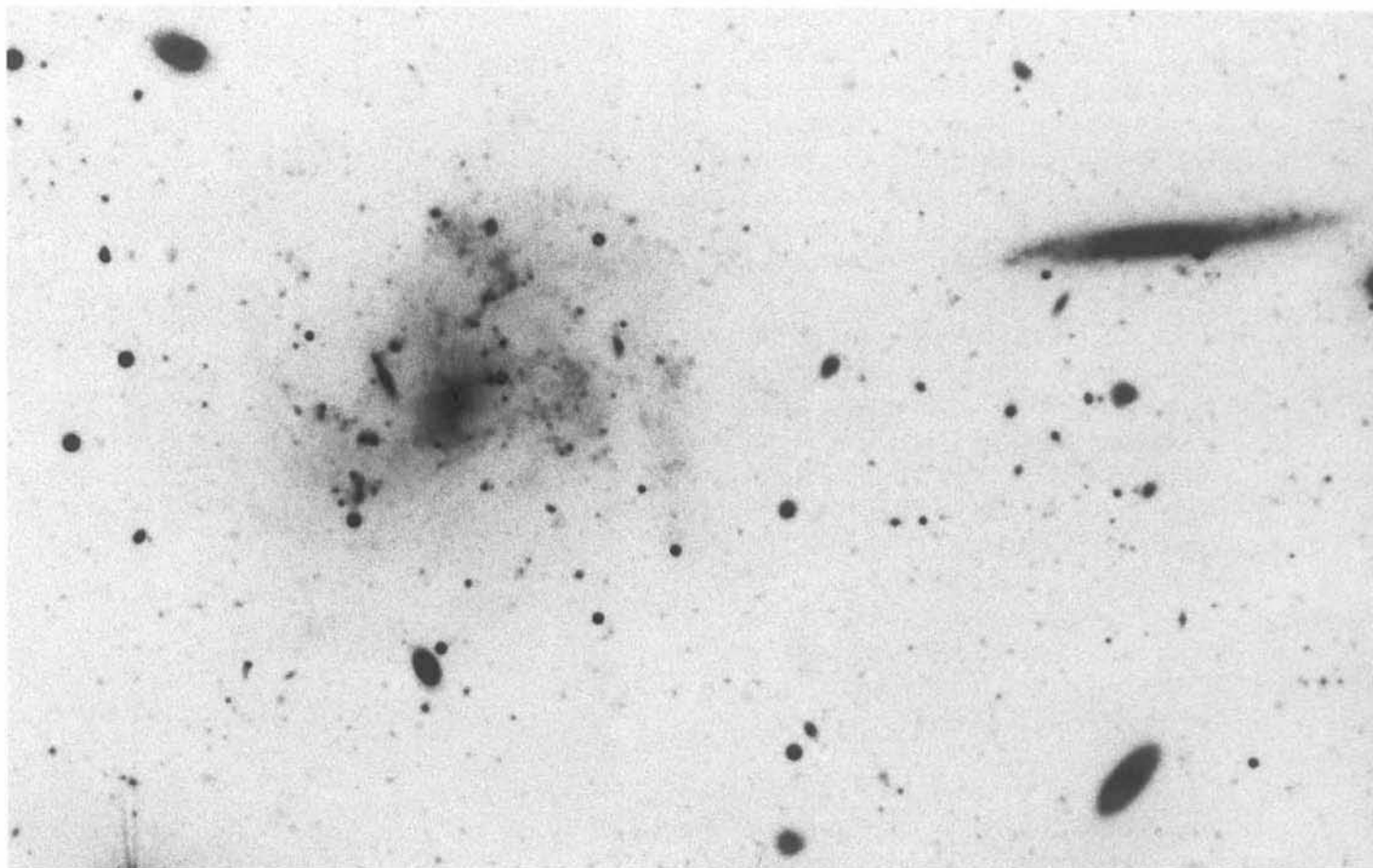

91 IC 5174 (below) and IC 5175 (above) are two spiral galaxies that are in obvious gravitational contact. Both have about the same radial velocity, 11000 km/s, corresponding to a distance of 550 million light-years. This double system is unusual because of its enormous size. IC 5174, which has two long, open spiral arms, measures no less than 750000 light-years from tip to tip. Very few galaxies of such a size are known. In addition to the outer arms, an inner, spiral structure is visible on this picture. The other galaxy, IC 5175, is a late-type spiral, seen almost edge-on. In order to show the faint arms of IC 5174, this photo was computer-enhanced. The foreground, galactic star, between the two galaxies, is of magnitude 11, that is 100 times fainter than can be seen with the unaided eye.

It is believed that the IC 5174-75 system is similar to the famous, northern spiral M 51 ("The Whirlpool"), but that it is seen from a different angle, and is several times larger.

92 The Antennae galaxies, NGC 4038-39, are two galaxies in collision, from which two long and narrow tails emerge. The tails are separated in space, and the apparent crossing is a projection effect. The distance of this splendid object is 70 million light-years and the projected distance from one tail tip to the other is nearly half a million light-years. As can be seen, the width of the tails is only a few per cent of that amount.

Extensive computer calculations have made it possible to find a plausible scenario for the collision event. Originally, NGC 4038 and NGC 4039 were two quite normal spiral galaxies, but some 700 million years ago their motions in space brought them near each other in a close encounter. The gravitational interaction of the two disks stripped off some of the stars and sent

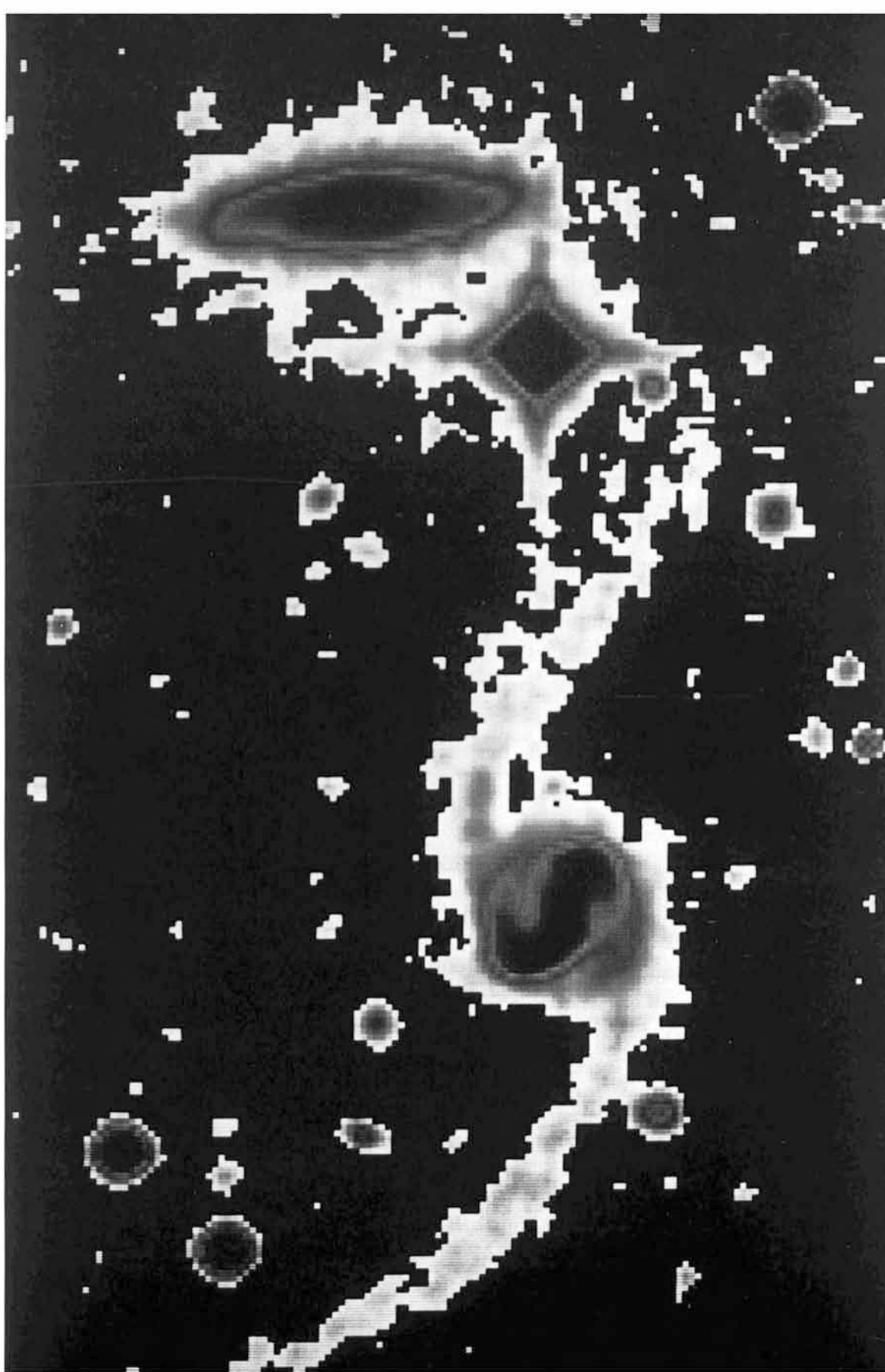

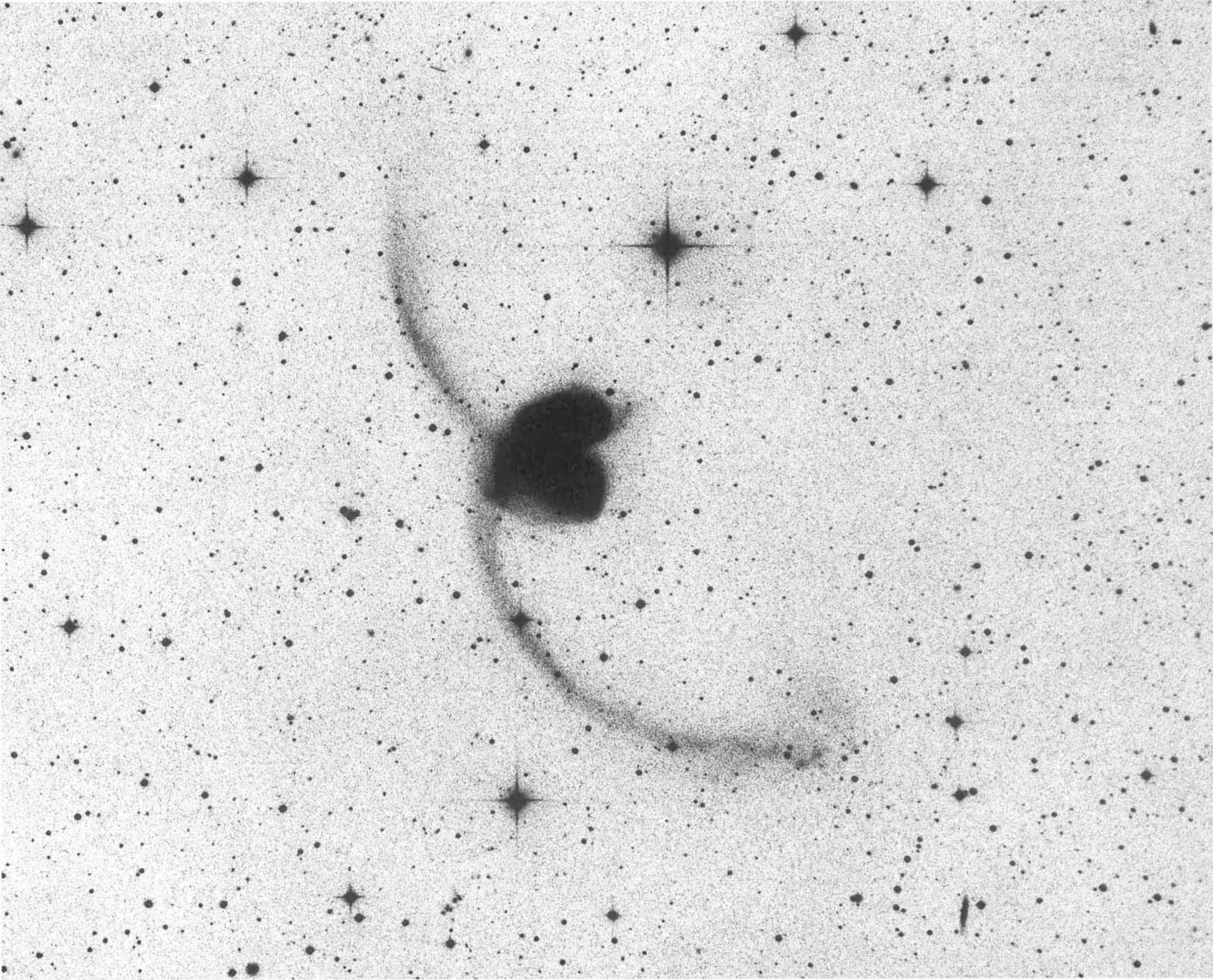

them into orbits that formed the two tails we see today.

It has been confirmed that the tails mainly consist of stars that were born before the collisional event. Most interestingly, radio measurements have also shown the presence of gas in the arms. Optical measurements in the tip of the southern tail have revealed a stellar population so young that the stars must have been born in the tail itself. The revelation that a collision between galaxies may result in star formation in stellar bridges or tails, far from the two colliding galaxies, is completely new. The process may apparently also give birth to new dwarf galaxies. It is not easy to see in the photo, but the outer part of the southern tail is now breaking up into smaller parts. Of these, the outermost one especially is apparently very similar to the dwarf irregulars of low surface brightness that we know in the Local Group, for instance SagDIG or NGC 6822 (Plates 66 and 67).

93 This short exposure of the Antennae galaxies (Plate 92) impressively illustrates the chaos after the collision. Imagine two well-separated spiral galaxies, both rotating with velocities of about 200 km/s. Then they move into each other with a relative velocity of a few hundred km/s. A great mass of stars and gas is thrown out by gravitational forces and forms the tails. Due to the vast distances between individual stars in the spiral arms of the galaxies, direct collisions between two stars are rare. Most of the interstellar gas collides, however, and develops into a form of gigantic tornado, which enhances star formation in several areas.

The result is seen here: a mixture of emission nebulae around groups of young stars and clouds of dust. The two galaxies have lost their original, regular, spiral structure, but they still survive as individual galaxies instead of merging into one single object. The two galactic nuclei can be distinctly seen on infrared plates, and in the course of maybe a billion years, these nuclei may regain gravitational control over their respective remaining masses.

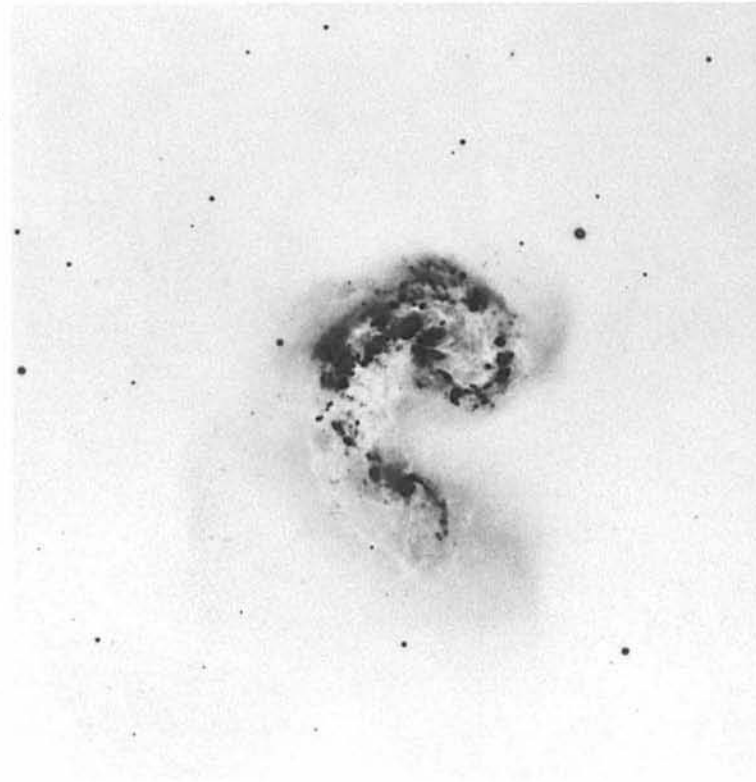

1.6 Clusters of Galaxies

Clustering of galaxies is a dominant property of the large-scale structure of the Universe. Most galaxies form part of multiples, groups, clusters and superclusters. The Milky Way Galaxy and its satellite galaxies are members of the Local Group. The Local Group, the Sculptor Group and other neighbouring groups, together with the Virgo Cluster, form the *Local Supercluster*, which is a huge, elongated and flattened system containing several thousand galaxies. Roughly speaking, it is a disk with a length of 90 million, a width of 50 million, and a thickness of 10 million light-years. Neighbouring superclusters are built up in a similar hierarchical manner, and have similar dimensions. Galaxies that do not belong to any cluster are called *field galaxies*. However, during recent decades it has become more and more questionable whether such galaxies exist at all. It is very doubtful indeed, whether any galaxy manages to stay outside the hierarchical order of the world.

What then do we find between the superclusters? The correct answer seems to be, close to nothing. Enormous, so-called *voids* have recently been shown to exist between the superclusters. These voids certainly contain very few galaxies, but exactly how empty they are still has to be determined. Flattened superclusters, such as our local one, are like separating walls between the voids, and together the superclusters form a cellular structure. An example of such a cellular structure is shown in Fig. 7, in which each point represents a galaxy.

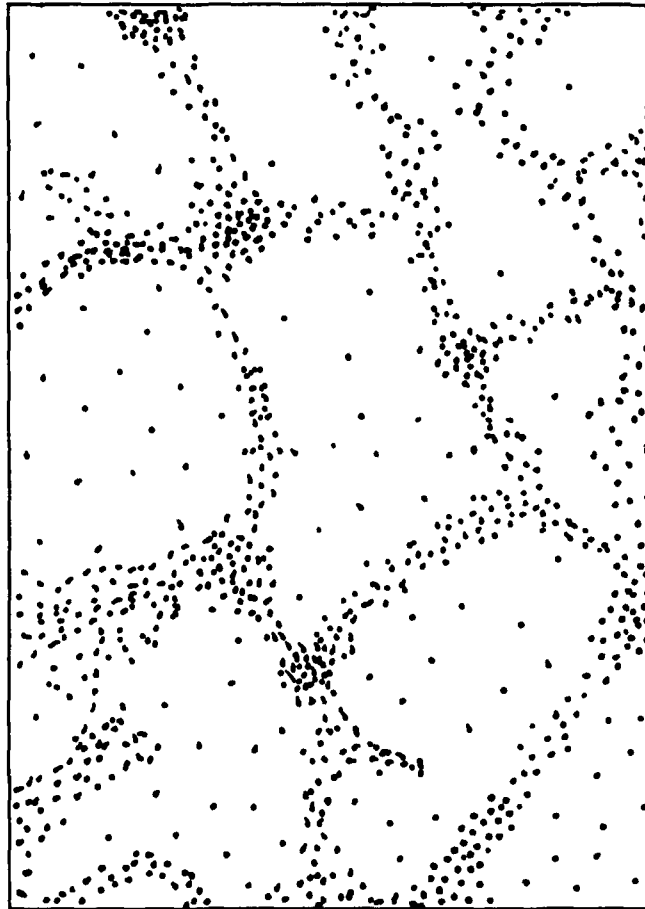

This figure is the result of theoretical investigations into the development of the early Universe in accordance with the so-called *pancake theory*. This suggests that compression of the gas at an early phase of the Universe may have formed sheets, which then grew in size until they split up into clouds and formed the cellular structure shown. Galaxies would be born in large numbers in the compressed gas. They would remain together in clusters and retain the structure of voids surrounded by thin walls, and which we still observe today. It is obvious that such a scenario for the formation of galaxies, clusters and voids must still be rather rudimentary. Many more, painstaking observations will have to be made before a more detailed picture of these events in the early Universe can be outlined.

Fig. 7



94 The Virgo Cluster is the nearest, rich cluster of galaxies. Its dense, central part covers an area 6° in diameter. At a distance of 70 million light-years, this corresponds to a linear extent of 7 million light-years, or somewhat less than the diameter of the Local Group. The density of galaxies in the Virgo Cluster is, however, much higher than that of the Local Group. The total angular extent of the Virgo Cluster is difficult to define, but it is certainly much larger than the 6° men-

tioned, and the total content of galaxies may well add up to 10000–20000.

The photo shows a small field near the western edge of the central region. Even so, it contains quite a few bright galaxies and no less than four objects from Messier's catalogue. M 98 is a nearly edge-on, Sb galaxy, and M 99 is a beautiful, multi-arm Sc galaxy, seen face-on. M 84 is an E1 and M 86 an S0 galaxy. Also worth noting is NGC 4299, a very late-type spiral clas-

sified as Sd. These and other galaxies can be identified by means of Fig. 8. M 87 is a famous elliptical galaxy near the centre of the Virgo Cluster, which is itself outside this field. See Plates 117 and 118.

Two hundred years ago, Charles Messier noticed the unusually high frequency of nebulae in the region on the borders of the constellations of Virgo and Coma, and the Messier catalogue contains no less than 15 galaxies in the area of the Virgo Cluster. Later, in 1851, the German natural scientist Alexander von Humboldt (1769–1859) in his "Kosmos" mentioned that a third of all known nebulous objects were apparently located in the relatively small, Virgo/Coma area. But it was only after 1920, when galaxies were correctly identified as stellar systems outside our own Galaxy, that the true nature of this mysterious concentration of nebulae could be established. It is the combined effect of the rich Virgo Cluster and the even richer, but more distant, Coma cluster of galaxies.

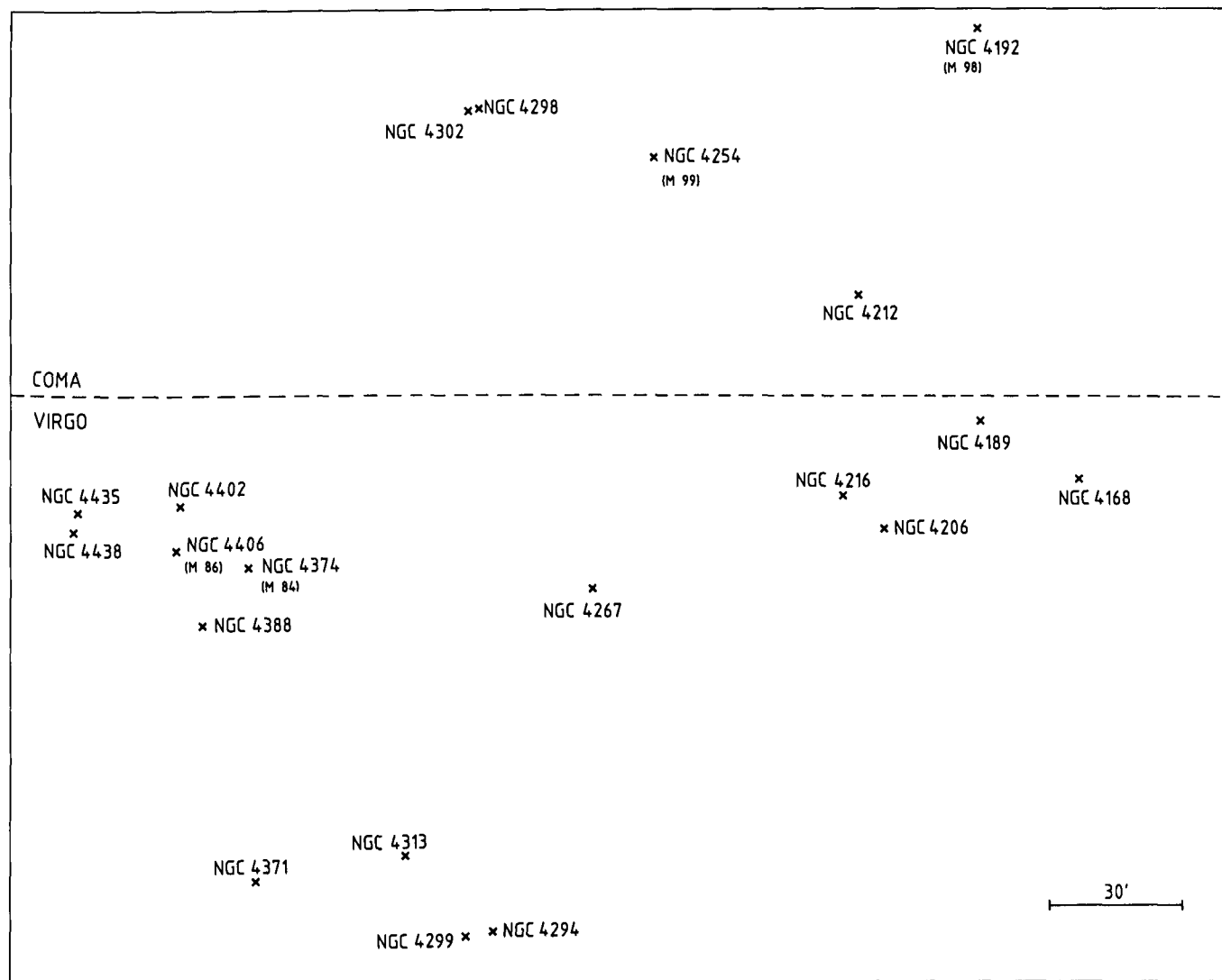

The Virgo Cluster of galaxies is a most impressive object. Much has been learned about it during the past 70 years, but even today the Virgo Cluster is slow in disclosing its secrets. A major problem is that the total “visible” mass, that is the sum of all the matter that is seen in the member galaxies, is not enough to render the Virgo Cluster dynamically stable; the observed mass is too small to keep the cluster’s galaxies together in space. However, since the Virgo Cluster must have existed for a long time, it must also be relatively stable; hence there is an obvious contradiction. This is often referred to as the “problem of the missing mass”. Recently, a huge cloud of very warm, X-ray-emitting gas was discovered near the centre of the Virgo Cluster. This may form part of the “missing mass”.

95 This photo shows part of a large cluster of galaxies in the southern constellation of Hydra (the Water Snake). The gravitational centre of this cluster, also called Hydra I, is near the dominant galaxies NGC 3309 and NGC 3311, which were described earlier (Plates 9 and 10). The cluster is rich in spiral galaxies, especially in its outer areas, while the ellipticals and the dwarfs preferentially populate the central area. The few spirals near the centre are all abnormal. They lack gas, with the result that star formation in them has come to an end. As their stars have evolved, their originally blue disks have now become red.

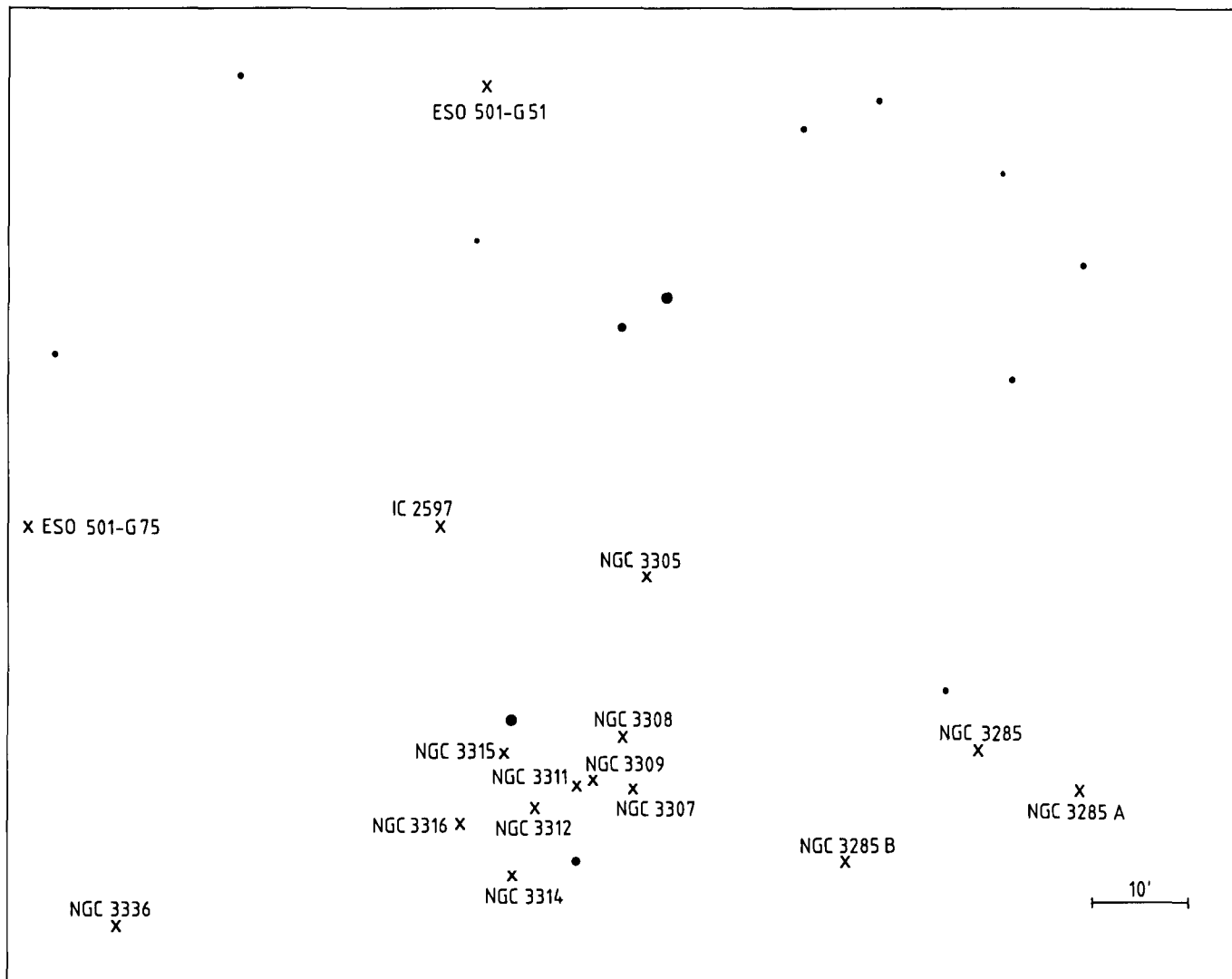

An extensive programme for the determination of radial velocities, and therefore the distances of the Hydra I galaxies, is in progress at ESO. One aim is to establish a three-dimensional model of the cluster, that is the distribution in space of the member galaxies. Another important goal is to determine accurately their luminosities (magnitudes) and to establish how many member galaxies there are of a given brightness

(the luminosity function). The Hydra I Cluster is particularly well suited for such studies because it is quite isolated in space. It lies at a distance of 170 million light-years, and the space in front of, and behind it, at least out to a distance of 400 million light-years, is practically devoid of galaxies. We can therefore be sure that virtually all galaxies in the photo belong to the Hydra I Cluster, even the fainter ones.

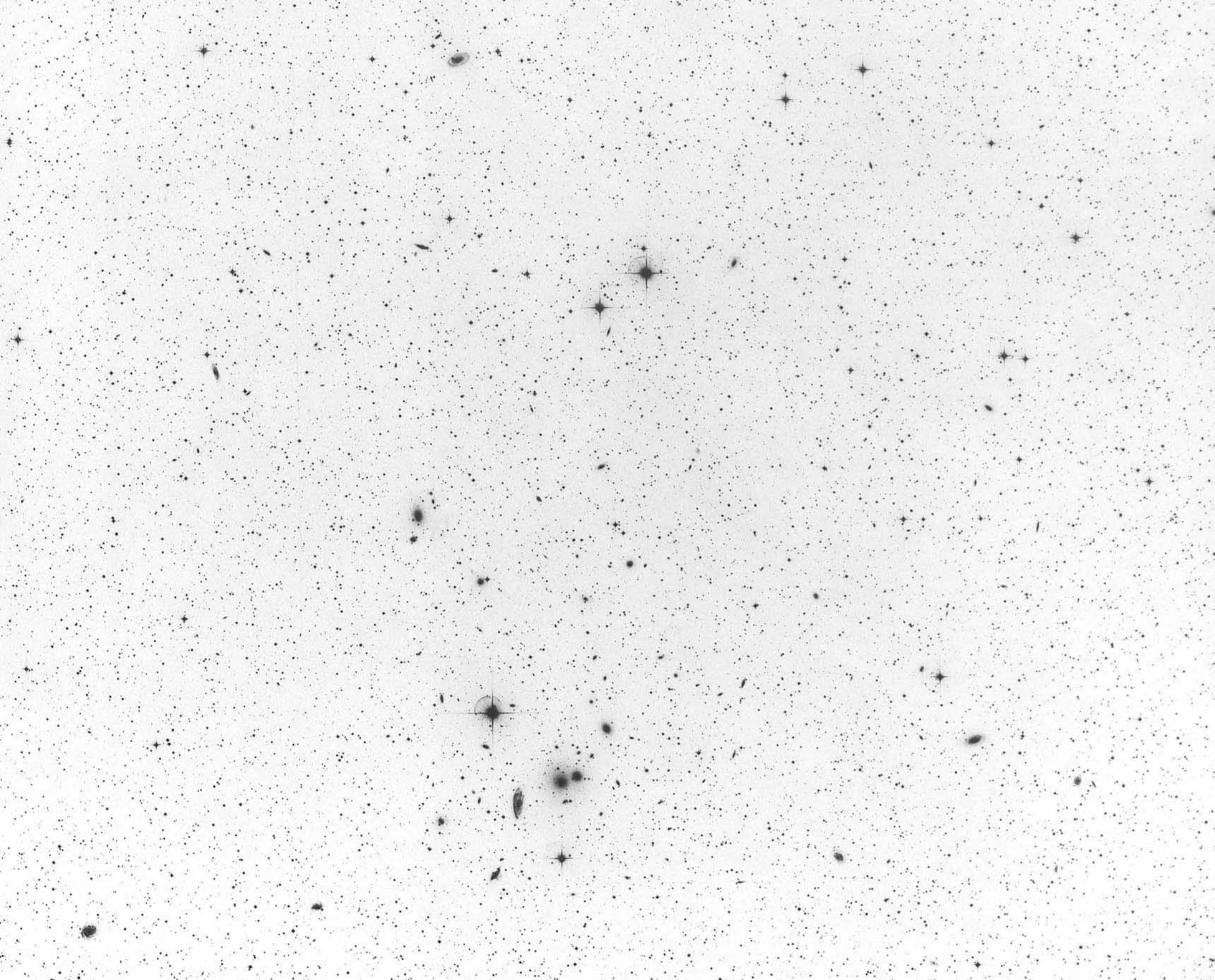

96 Far south, in the constellation of Pavo (the Peacock), we find this interesting group of galaxies at a distance of 190 million light-years. The central galaxy of the Pavo Group is an E3 giant, NGC 6876. Its neighbour NGC 6877 is classified as E6. The large spiral galaxy NGC 6872 is even more impressive. It is a barred spiral of the SBb type, but with excessively extended spiral arms. IC 4970 and NGC 6880 are S0 galaxies, IC 4972 is an Sbc spiral, and IC 4981 is of the irregular type. Thus, the few galaxies in the Pavo Group together illustrate much of the Hubble sequence.

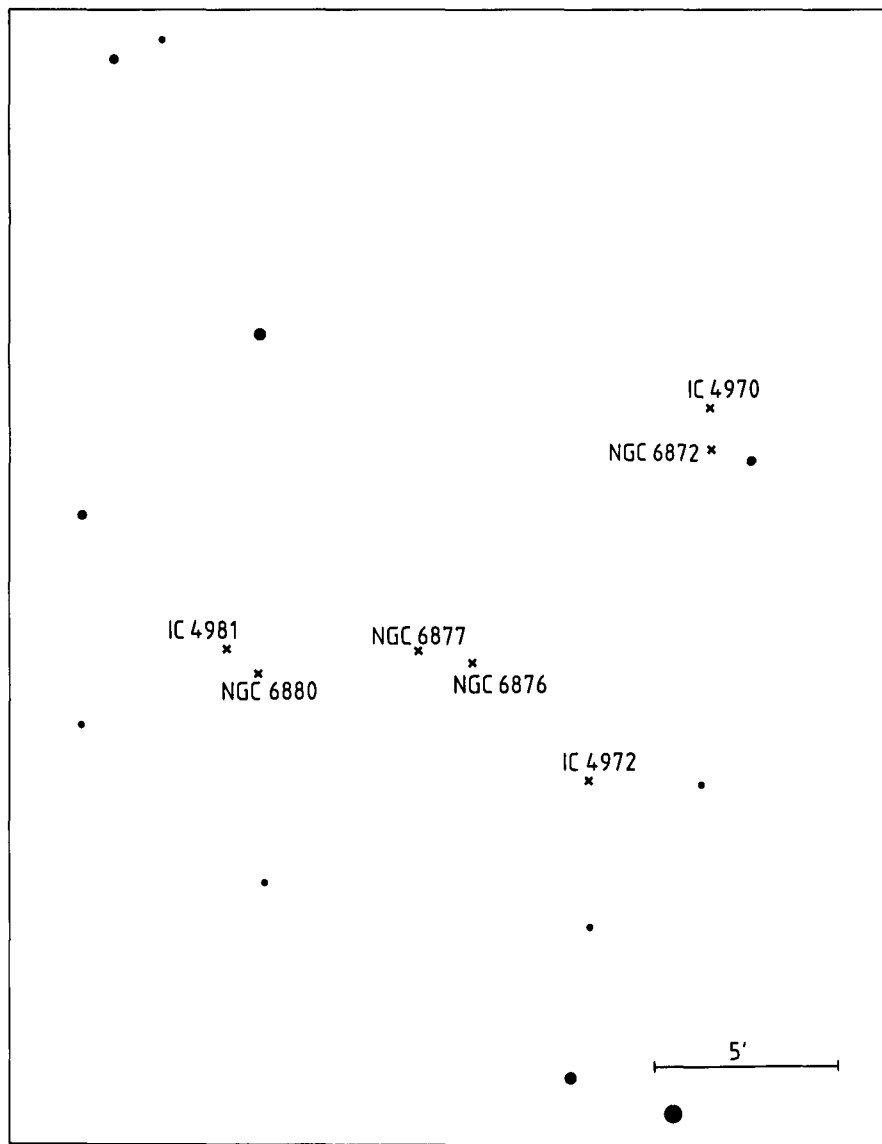

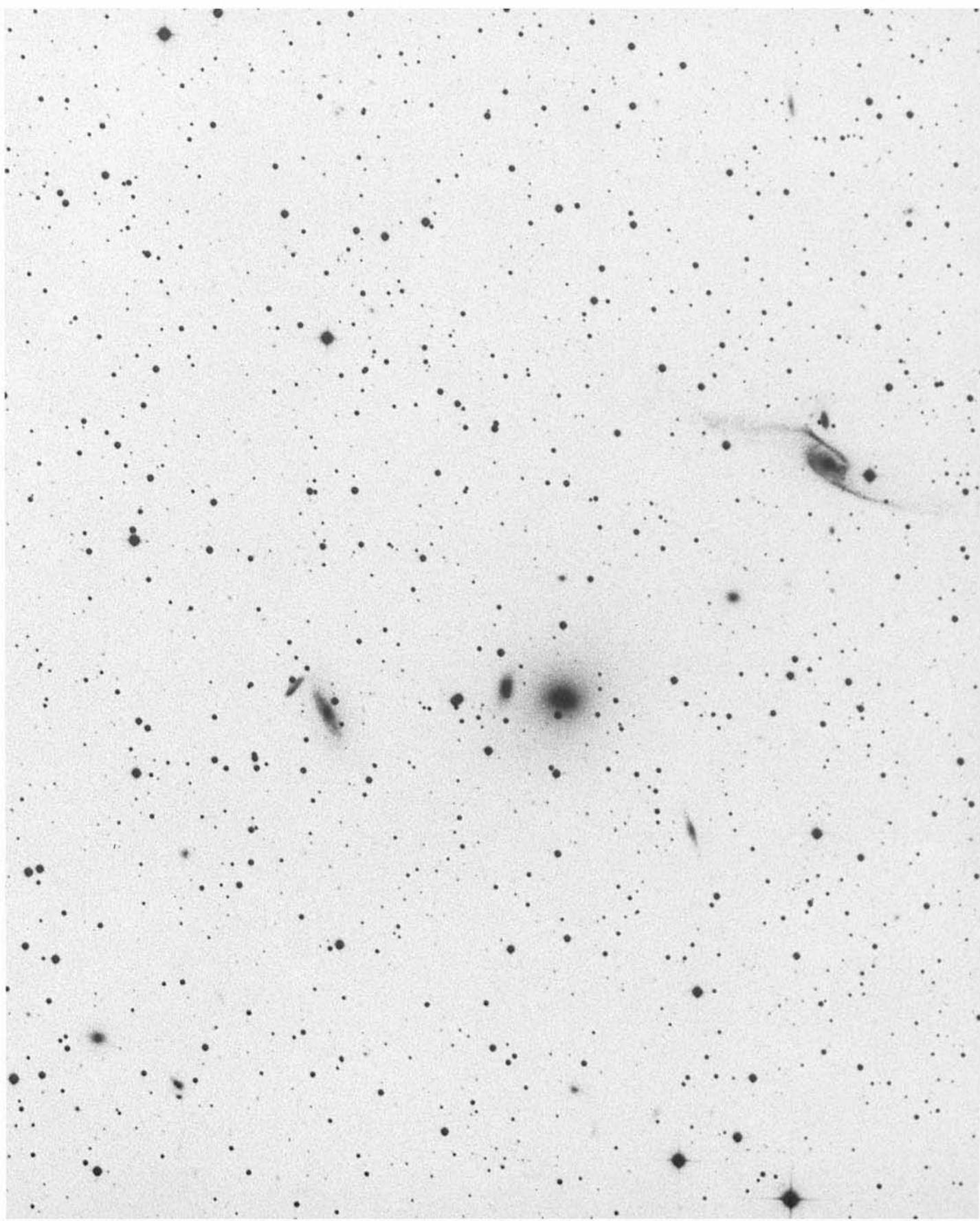
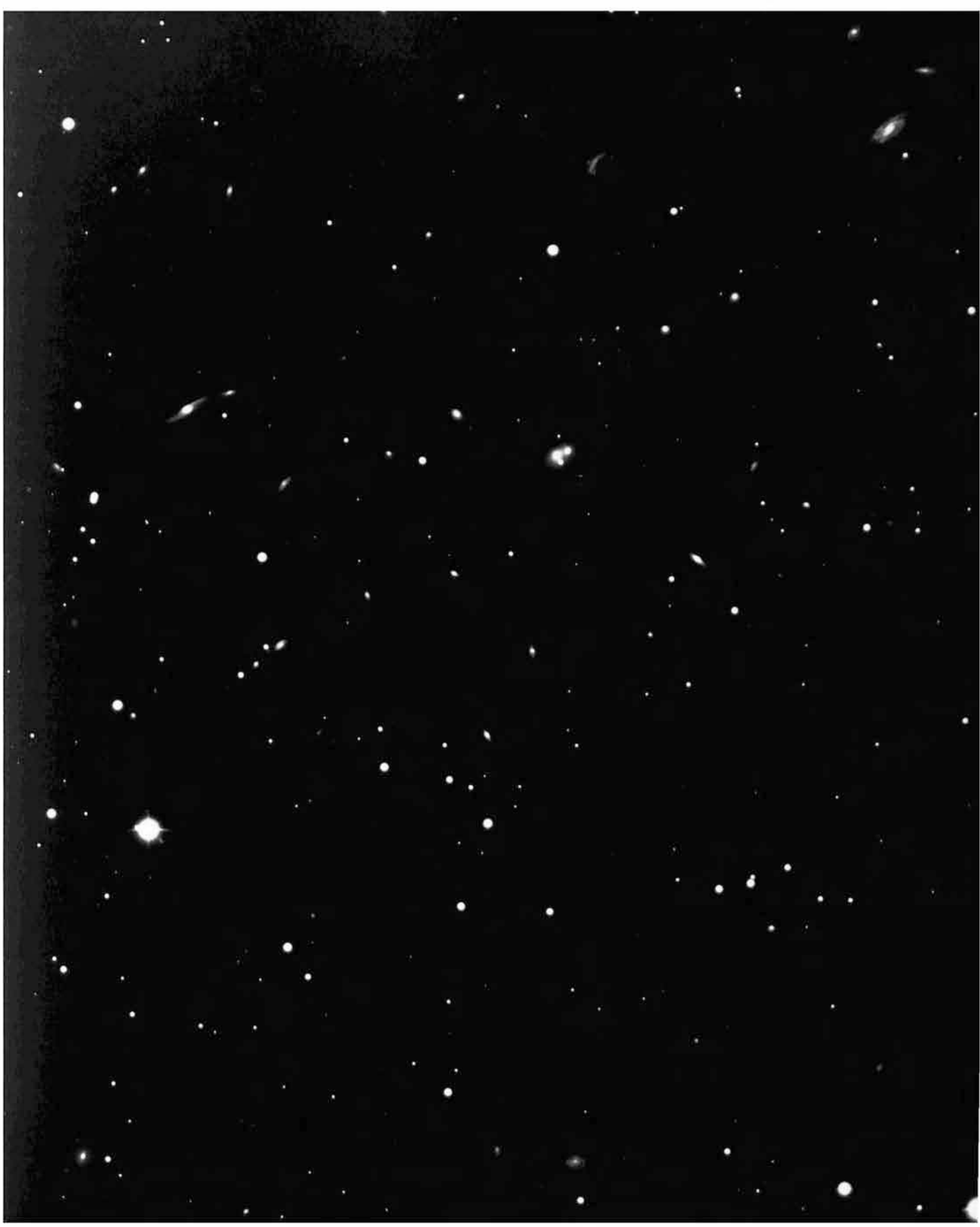

Plate 96



97 Near the 4th-magnitude star δ Sculptoris we find the cluster of galaxies Klemola 44, which is 400 million light-years away. This cluster is rich in early-type galaxies, while the spiral galaxies are poorly represented. There is not a single galaxy of a type later than Sb in the photo. Near the centre we find the cD galaxy NGC 5358, another example of the very extended giant galaxies with a low concentration of stars towards the centre. It is rather similar to NGC 3311 (Plates 9, 10 and 95).

98 Down in Dorado, which is dominated by our nearest neighbouring galaxy, the Large Magellanic Cloud, we also find the IC 2082 cluster, which is 3000 times more distant than the LMC. Although at a distance of 600 million light-years, we can still see a fair number of galaxies of both elliptical and spiral types. The brightest galaxy, IC 2082 itself, is a giant elliptical, or possibly a cD galaxy, with a close companion. The companion is an elliptical galaxy, and the two have a faint common envelope.



99 Several distant clusters of galaxies are seen in this area, near the northern border of the constellation of Centaurus. The brightest galaxy, which is situated north-east of the centre, is ESO 444-G 46, at a distance of about 700 million light-years. It is the central galaxy in a rich cluster containing large numbers of elliptical galaxies. Other clusters of galaxies at the same dis-

tance are seen on the Plate, and together they make up a supercluster in this direction. A number of relatively strong X-ray sources have been detected in this area of the sky. They are likely to be hot, intergalactic clouds that are invisible on conventional photographs. These clouds are undoubtedly associated with the clusters of galaxies seen here.

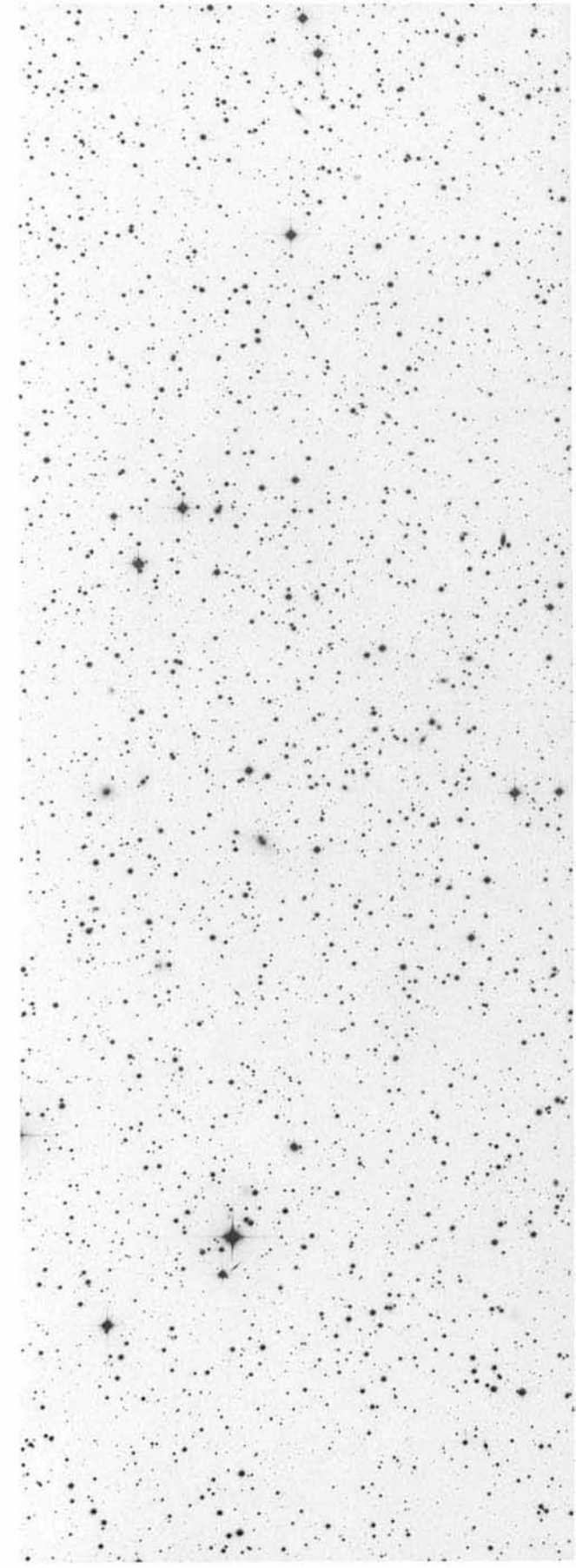

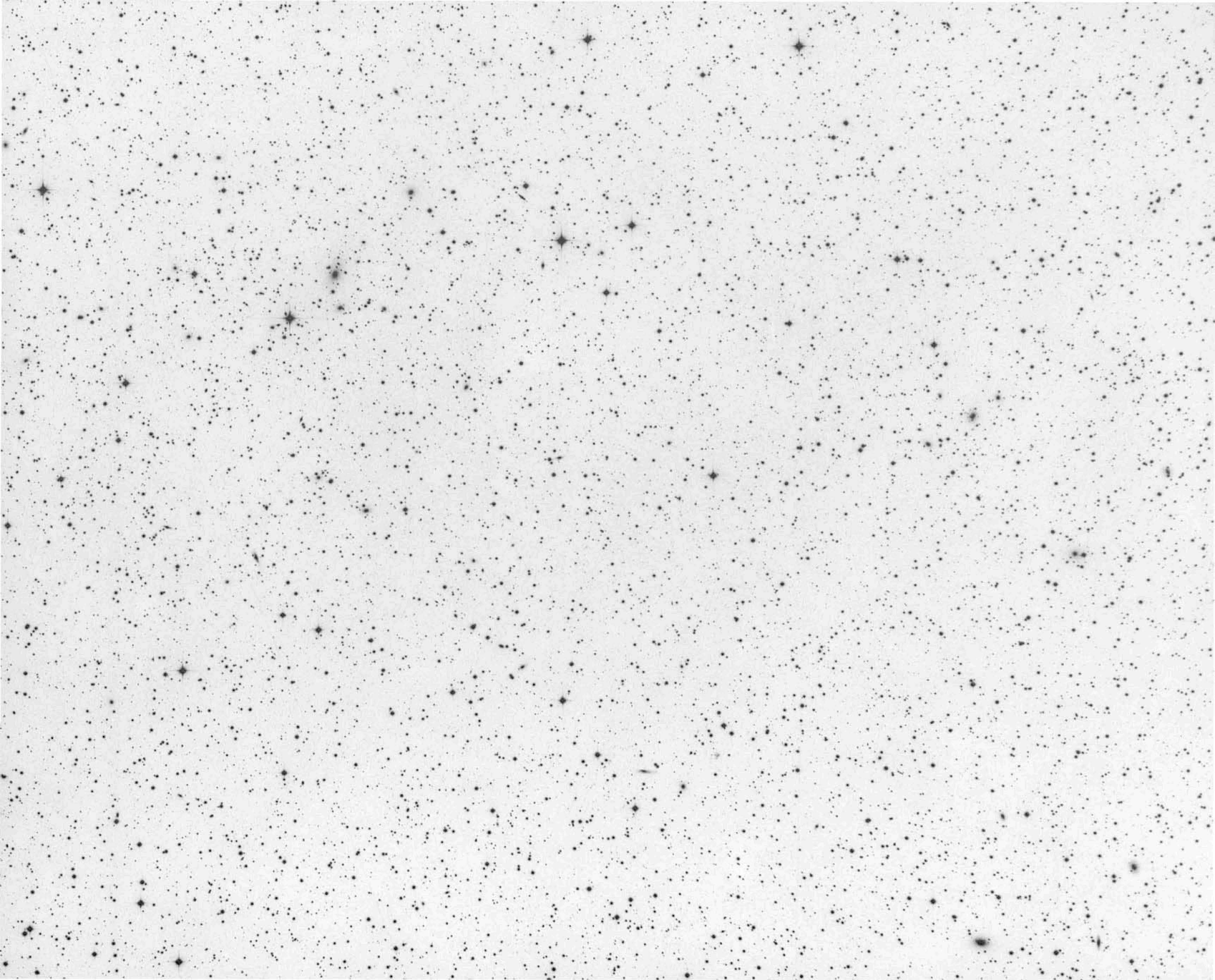



1.7 Peculiar Galaxies

Most, if not all, galaxies have certain peculiarities, but in some cases the abnormal features are dominant. We then say that the galaxy is “peculiar”. NGC 5128 (Plates 12–15) is a good example of a peculiar galaxy.

Peculiar galaxies are important objects in astronomical research. They play the same role as pathological cases do in medical science. Whether the peculiarity is the shape of the spiral arms, the size of the nucleus, or the distribution of interstellar matter, it tells us that something unusual has happened in this galaxy. Our attention is drawn to this particular object. Further research, often with a great variety of techniques, and in different spectral regions, may then lead to an understanding of the process that has caused the peculiarity. We thereby gain new insight, not only about the peculiar galaxy itself, but also about normal galaxies, which did not develop that particular peculiarity.

Among the peculiar galaxies, the ring galaxies form a special class and we shall first look at a few examples of this type.

100 In the constellation of Ara (the Altar), close to the band of the Milky Way, we encounter this ring galaxy, ESO 138-IG 29, with a companion to the south-east, ESO 138-IG 30. It is a fairly typical example of this class: there is a faint ring around a luminous core, which is somewhat off-centred within the ring. The structure of the core is like that of an elliptical galaxy or the nuclear bulge of a disk galaxy. Normally, as here, there is another galaxy close to the ring galaxy, and in most cases, this neighbour is a normal, elliptical galaxy. In the present system, the neighbour looks like a rather disturbed disk galaxy, and there is also a bridge of matter connecting the two galaxies.

A well-studied theory for the formation of ring galaxies is that the ring is created during an almost central collision between a larger, disk galaxy and a smaller, most frequently elliptical, galaxy. When the small galaxy passes through the disk of the larger one, the additional gravitational pull of its mass will temporarily affect the stars, dust and gas in the disk. As a result, after some time, an expanding ring will appear around the larger component (the core), and which will be visible for a limited period. The appearance of the present system can be cited in support of this theory, and the bridge between the galaxies can be interpreted as the tail of material drawn from IG 30 after the collision.

Unfortunately, this rather simple theory is not very well supported by statistical considerations. In particular, there are more ring galaxies seen in the sky than we would expect. In view of the small density of galaxies in space, central collisions between two galaxies with the proper orientations for the formation of a ring, as just described, must be exceedingly rare events. Perhaps there are other ways of making ring galaxies?

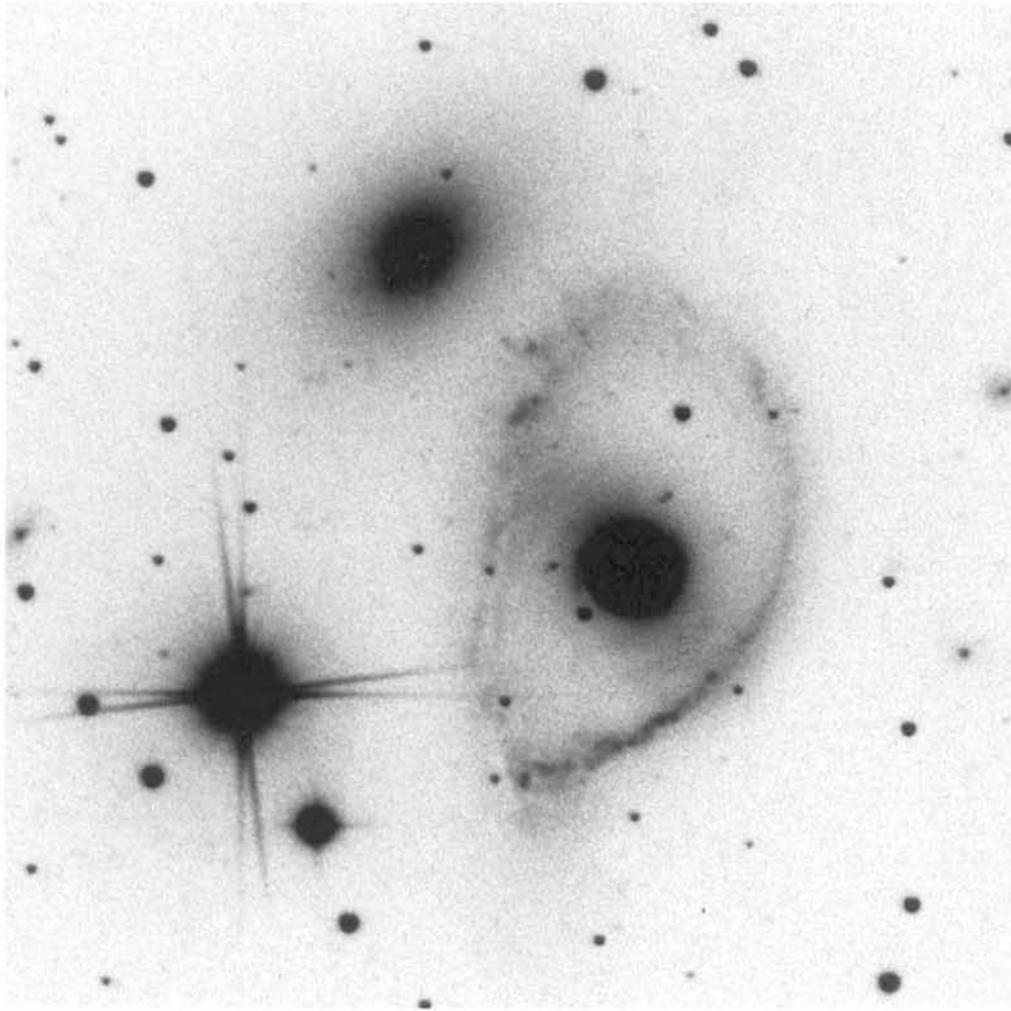

101 Another ring galaxy is ESO 316-IG 32, seen here with its fairly large, elliptical, neighbour galaxy ESO 316-G 33. The ring clearly contains knots, and several absorption lanes are visible. A faint bar within the ring crosses the core in a direction that points towards the companion. This feature may be the equivalent of the bridge in Plate 100. As in other photos in this book, the “spikes” protruding from the bright star are artifacts of the telescope optics.

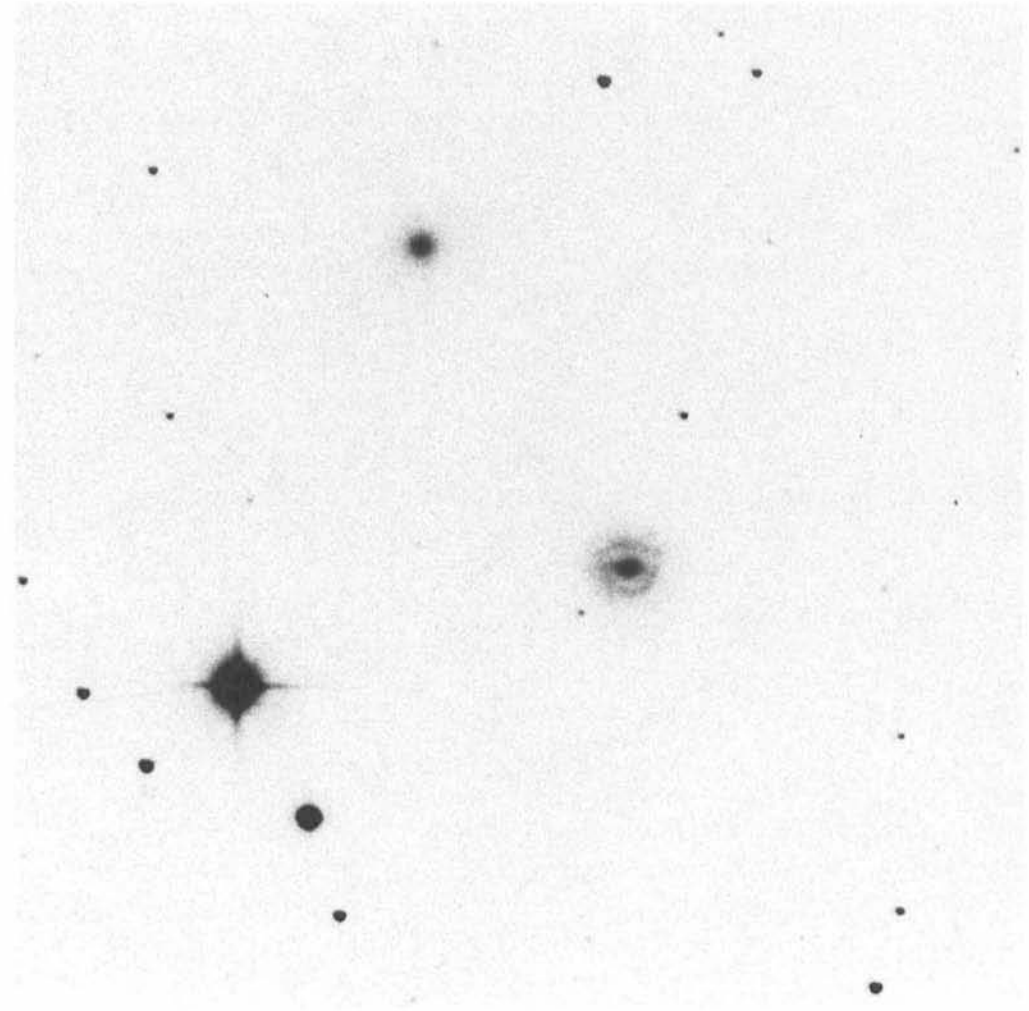

102 On this 5-minute exposure we see the nucleus of ESO 316-IG 32 surrounded by an inner ring. The diameter of this ring is about one seventh of that of the outer ring. Surprisingly, we also see an inner bar with an orientation quite different from that of the outer bar. The existence of both an outer and an inner ring as well as of a bar is consistent with the theory of formation of ring galaxies mentioned earlier (Plate 100). But the existence of *two* bars with

different orientations is difficult to understand. A tentative explanation is that one was present before the collision. Somehow it was able to survive the disaster, while a second bar was formed as the result of the collision.

103 The ring galaxy ESO 34-IG 11 has sometimes been called the “Southern Ring Galaxy”, since it was one of the first of its class to be identified in the southern sky. It is a typical ring galaxy, lying in a small group of early-type galaxies, of which some are seen here. Upon closer inspection, the ring turns out to be one single, very tightly wound spiral, which can be traced for two full revolutions. The knots on the ring are groups of hot, young stars, showing that star formation is still going on.

The radial velocities of the galaxies in the group have been measured and are all around 6500 km/s, corresponding to a distance of about 325 million light-years. The dimension of the major axis of the elliptical ring is therefore ~ 150000 light-years, or somewhat larger than the diameter of the Milky Way Galaxy. The distance to the nearest companion galaxy is probably of the same order.

The position of ESO 34-IG11 in the sky is rather close to the Large Magellanic Cloud and a less clear photograph taken at another observatory in 1960 led some astronomers to believe that it might be related to this galaxy. It was also suggested that it might be a planetary nebula in the Milky Way. However, a deep plate which was obtained during the ESO(B) Survey in 1972, immediately revealed the true nature of this intriguing object.





104 This is the central part of the Centaurus group of galaxies. It is also known as the *Centaurus Chain*, since no less than ten galaxies are nicely lined up in the sky. From right to left, we see here the double galaxy ESO 322-IG 64, the barred spiral NGC 4650, a smaller unnamed spiral galaxy, which is possibly a companion to NGC 4650, and finally the peculiar galaxy NGC 4650 A (Plate 105).

105 NGC 4650A is utterly peculiar. It consists of two components, the first of which is like an elliptical galaxy of type E7 in the Hubble classification. It is surrounded by a disk component, which is seen nearly edge-on and orientated almost perpendicular to the major axis of the central component. The disk has a condensation in the form of a ring, or possibly spiral arms. This is clearly visible on Plate 104. There it is also obvious that one side of the ring absorbs light from the central component, while there is no absorption on the other side. This shows that the elliptical component is centred within the disk component.

The system may be compared with NGC 5128 (Plates 12–15), but the disk component in NGC 4650A appears to be much more extended. On the present, deep photo, we can see faint features so far out that the diameter of the disk must be at least four times greater than that of the elliptical component. From the measured distance of NGC 4650A, 130 million light-years, we find that the disk measures more than 100 000 light-years across.

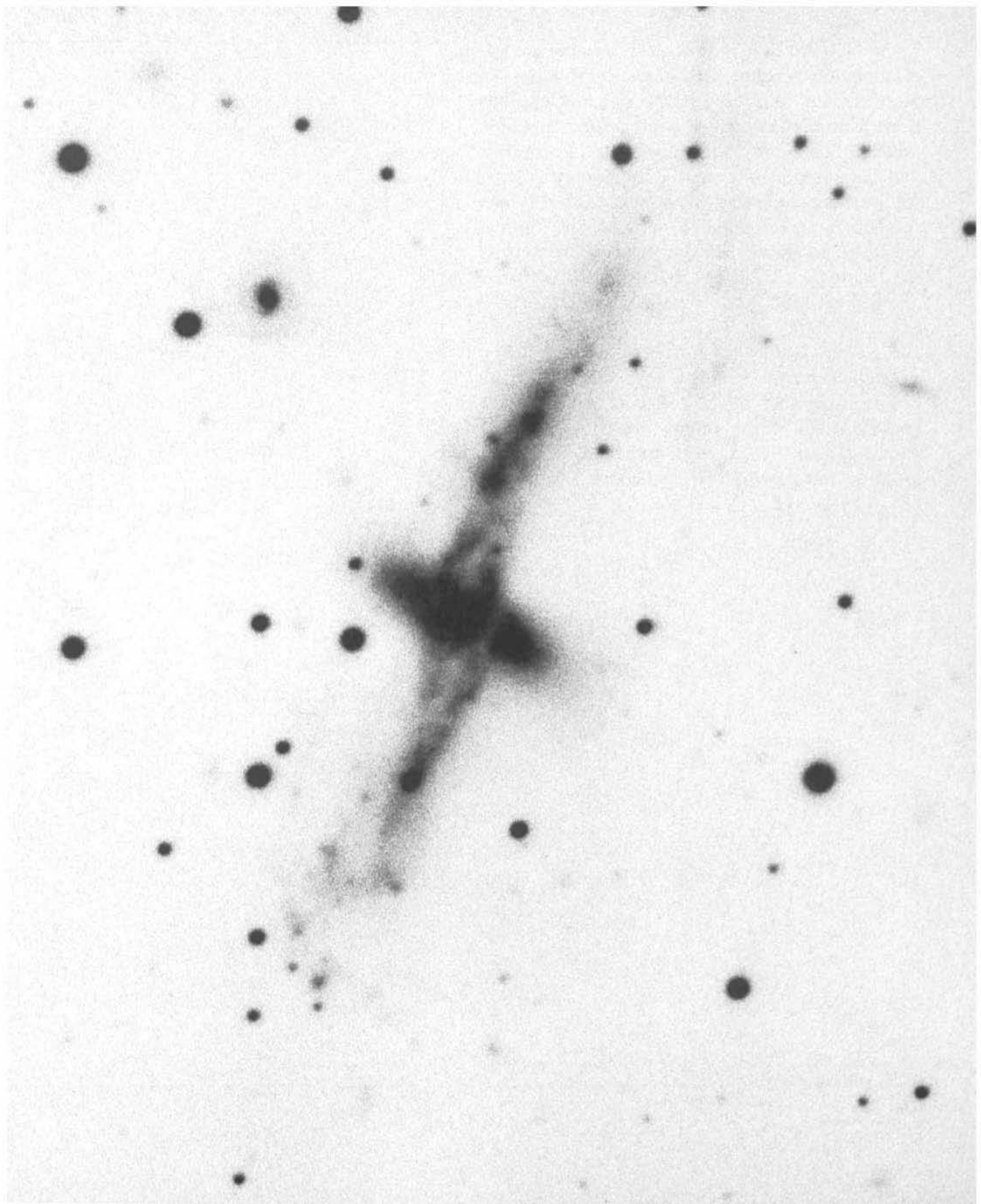

In NGC 5128 it is difficult to observe the nuclear region because of the absorbing band; in NGC 4650A it is easy. Only one nucleus has been found. A dedicated search for a possible second nucleus gave a negative result. From this, and the absence of a nearby companion galaxy, we must conclude that the system cannot be the result of a *recent* collision between an elliptical and a spiral galaxy. If the present structure is the result of a collision, it must have occurred a long time ago.

106 There is another cluster of galaxies in the constellation of Centaurus. It is named after its brightest member IC 4329, and is included here because of a most interesting member. The paired galaxies, NGC 5291 and the "Seashell", are shown in more detail on the next Plate.

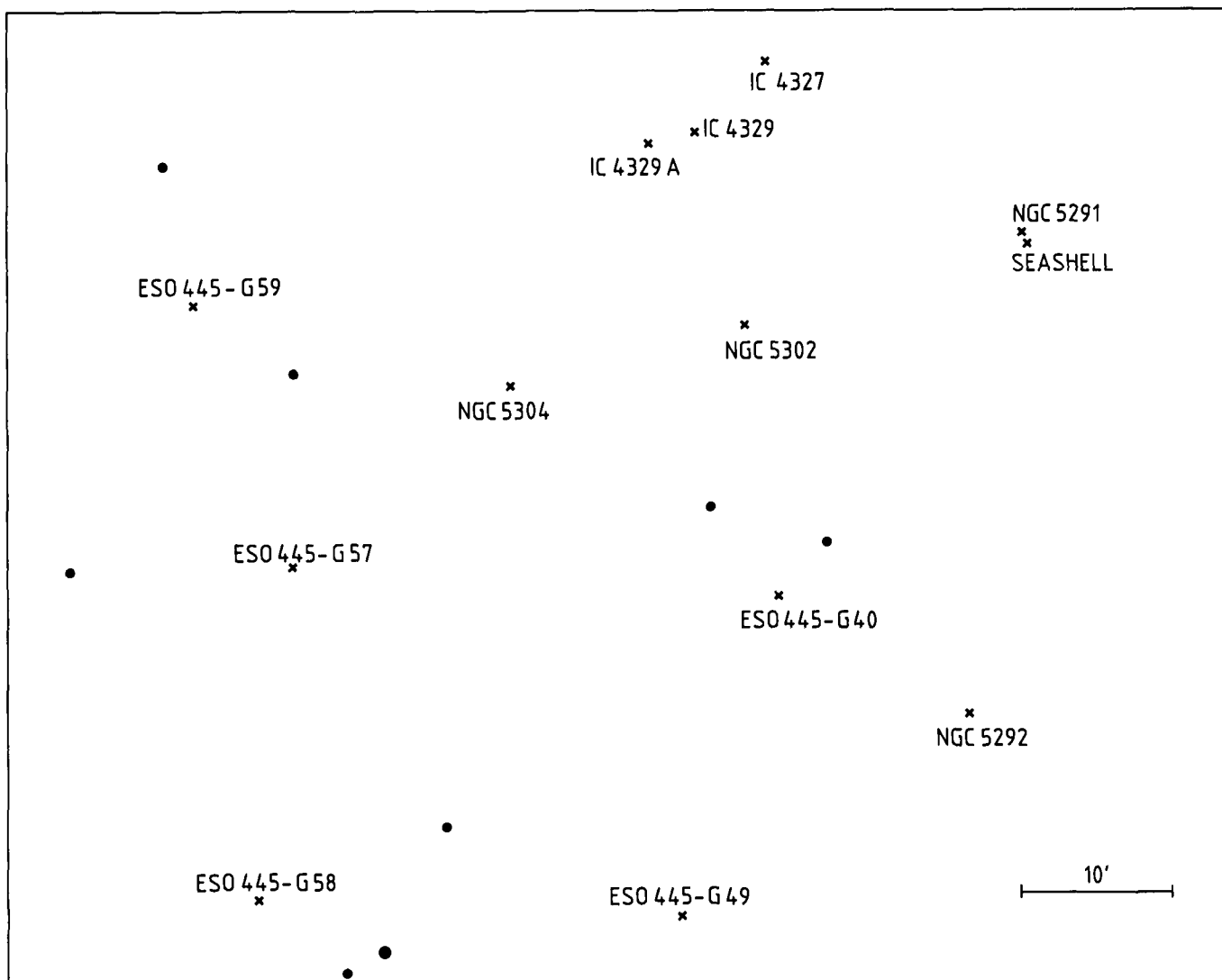

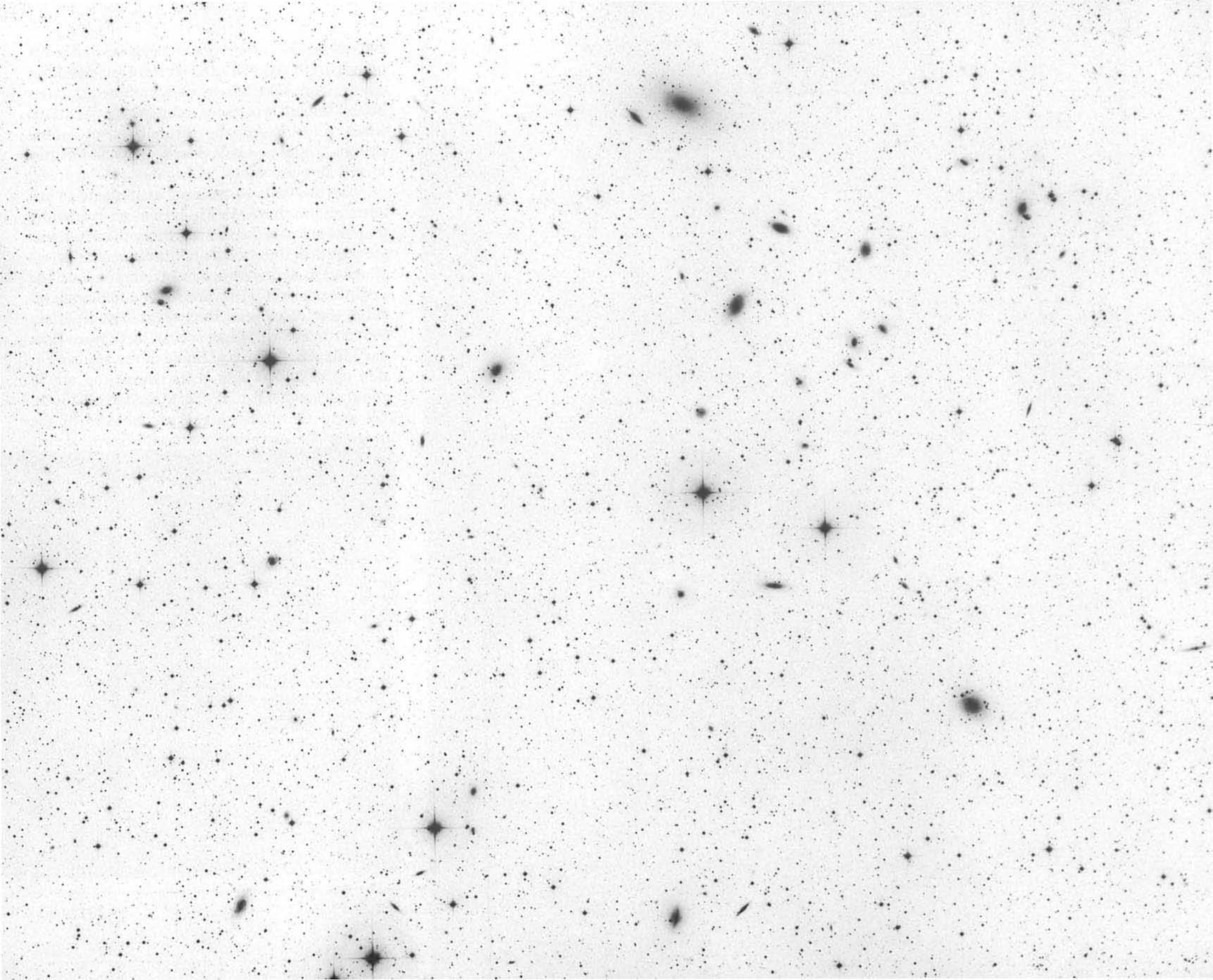

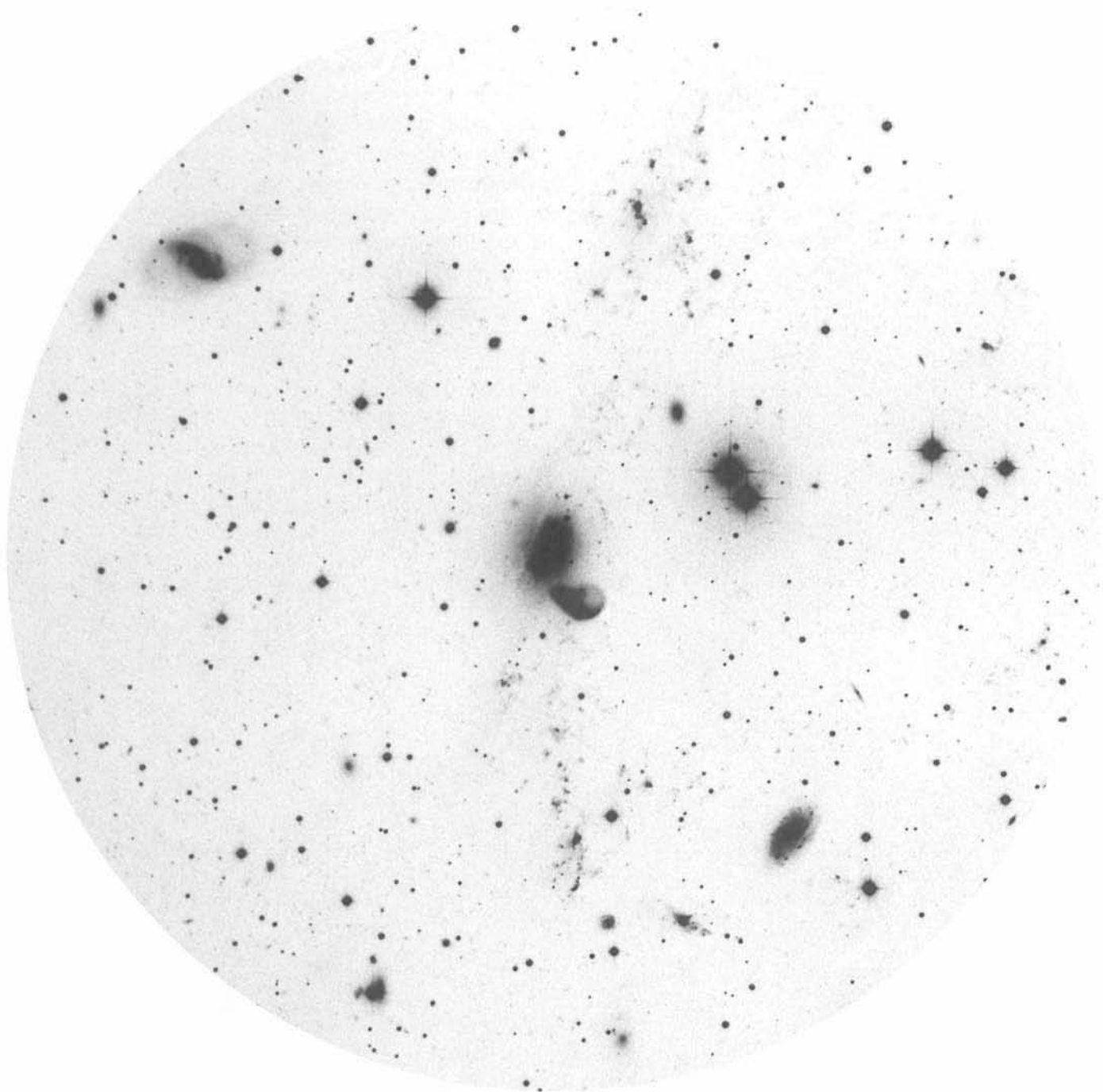

107 Near the centre of the field we find a famous pair, NGC 5291 and its strange neighbour, the Seashell. Both bear witness of strong gravitational interaction, in particular the Seashell, which must have gone through a substantial change. These two galaxies are classified as disturbed S0 type.

The two tails of material that point to the north and to the south are even more interesting than the galaxies themselves. More than 20 knots are visible in these tails, and filaments and wisps of quite some length extend from some of the brighter ones. At its distance of 280 million light-years, the total size of the system is no less than 600000 light-years, that is six times larger than our Milky Way Galaxy! Some of the knots measure up to 20000 light-years across and are of about the same size as the Magellanic Clouds. We seem to witness here how galaxies of the irregular type are being produced from the debris of other galaxies as the result of a collision or a close encounter.

This formation process is rather unusual, and most galaxies are formed directly from clouds of gas. On the following pages we shall see an example of this.

108 ESO 400-G 43 belongs to the class of *blue, compact galaxies*, a type of object that is not represented in the Hubble sequence. They are characterized by a high rate of star formation and a relatively low abundance of elements heavier than helium. This galaxy is among the largest and most luminous of its type; it has an irregular appearance with many hot spots and just a few dark clouds. It is apparent that G 43 must be a very young galaxy, in which star formation only started rather “recently” – using this word in the astronomical sense.

109 Astronomers at ESO have studied ESO 400-G 43 in the optical, in the infrared, and also in the radio domains of the electromagnetic spectrum. The radio measurements were extended to a large, surrounding area. To some surprise, it was found that the galaxy is embedded in a huge, somewhat flattened, cloud of neutral hydrogen, the total mass of which is about 7 billion solar masses. This is similar to the mass of a typical irregular or a small spiral galaxy.

In this picture, the optical and radio results have been combined. The yellow colour indicates the extended area of the cloud of neutral hydrogen, and the visible galaxy is shown as a series of colours of which the outermost is red.

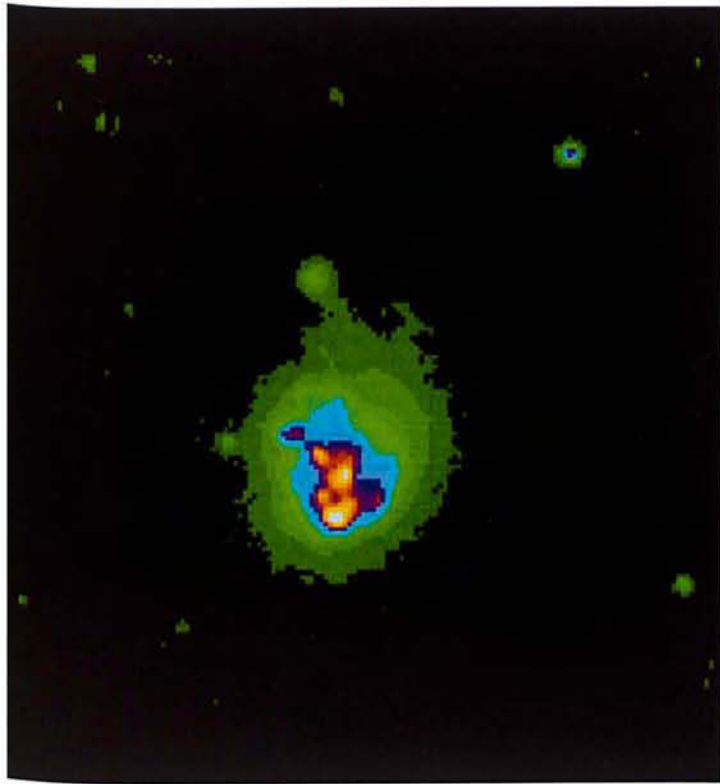

Plate 108

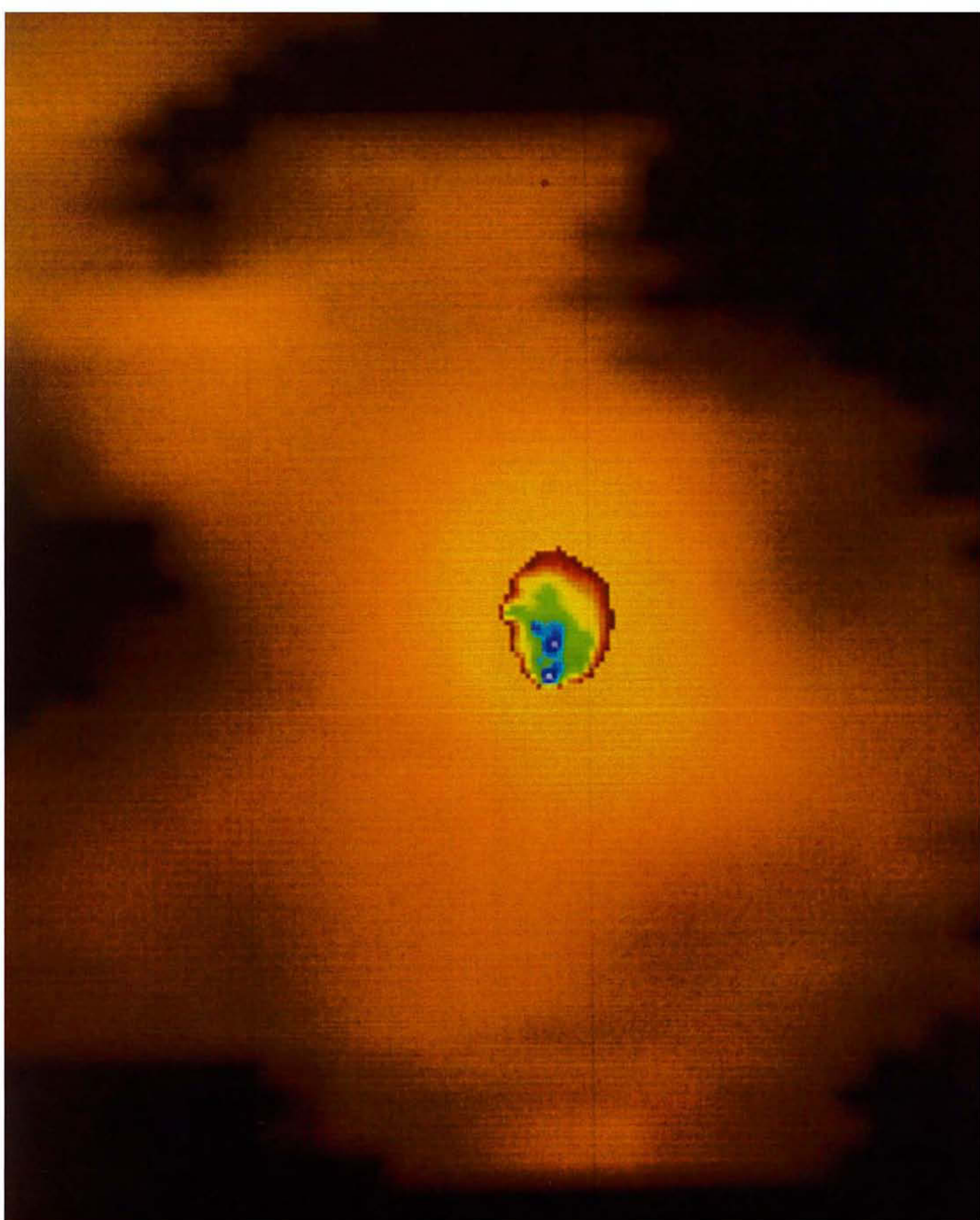
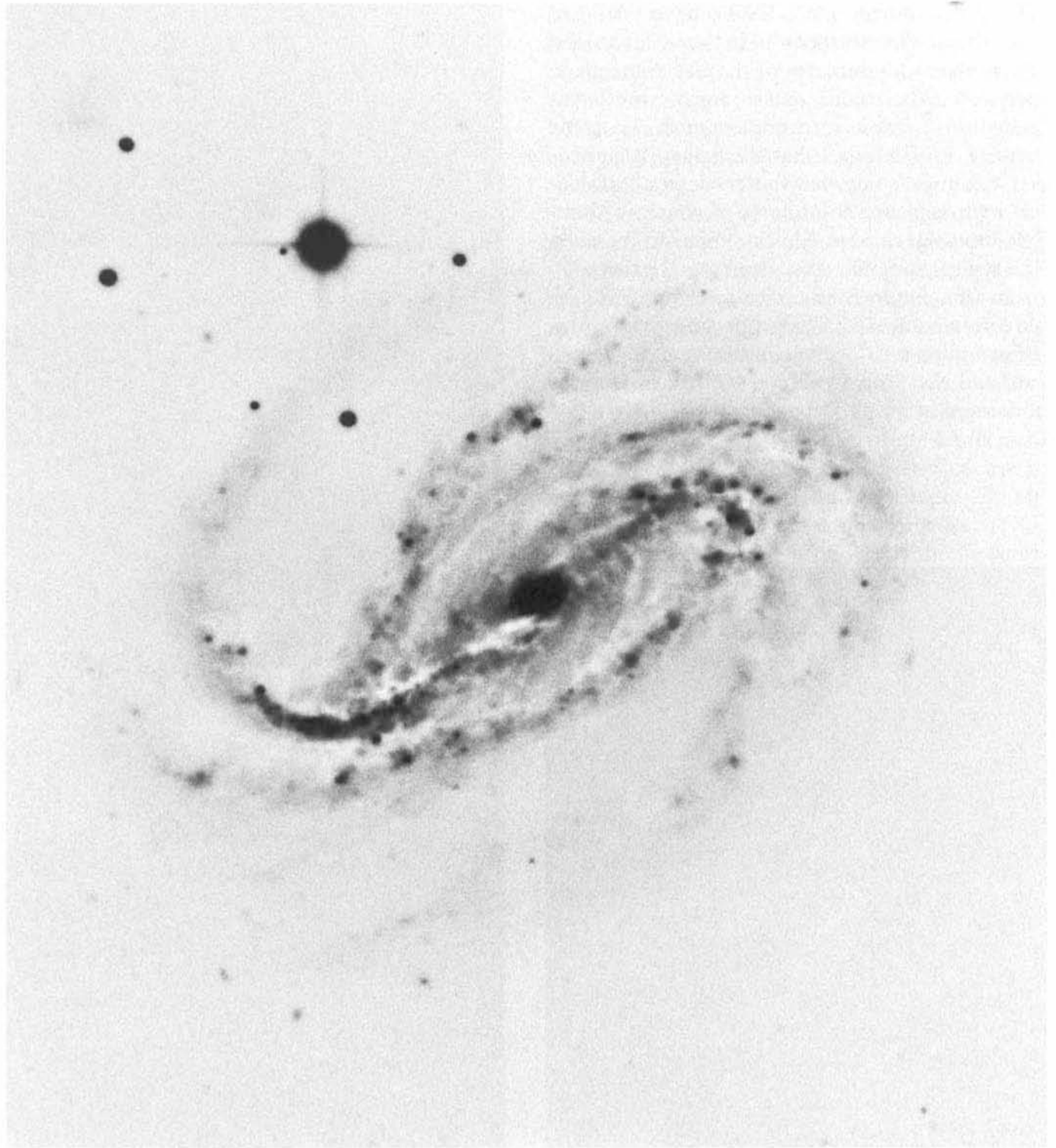

Plate 109

A current theory predicts that star formation takes place in “bursts”, that is periods of great activity, during which many stars are born. These periods are separated by longer intervals with little or no activity. In the case of ESO 400-G 43, a good agreement between theory and observation is obtained by assuming that the very first burst of star formation in this galaxy occurred only 30 million years ago, and that the second, or perhaps the third burst is happening just now. The total luminous mass of G 43 is estimated to be less than 1 billion solar masses. This means that only a small fraction of the surrounding cloud of neutral hydrogen has so far been used in the formation of the galaxy.

Future research will reveal whether the observations of this galaxy have been correctly interpreted. But even if the theory of star formation mentioned survives all future observational tests, a number of difficult questions still remain. Why, for instance, was the star formation only triggered so recently? Why did it not start many billions of years ago, when stars were first formed in other galaxies? Has the hydrogen cloud been there ever since the early epochs of the Universe or did it appear later? As is so often the case, scientific research may answer some questions, but in the process it raises more.

110 This pretty galaxy, NGC 613, is classified as SBc. It is seen at an inclination of 32° and the south-west side is the nearer one. Unlike most barred spirals it is a multiple-arm system. It has several well-defined arms with a large number of emission regions, but the most interesting feature is the nucleus. A small jet that protrudes from the area of the nucleus was recently detected by means of radio and optical observations.



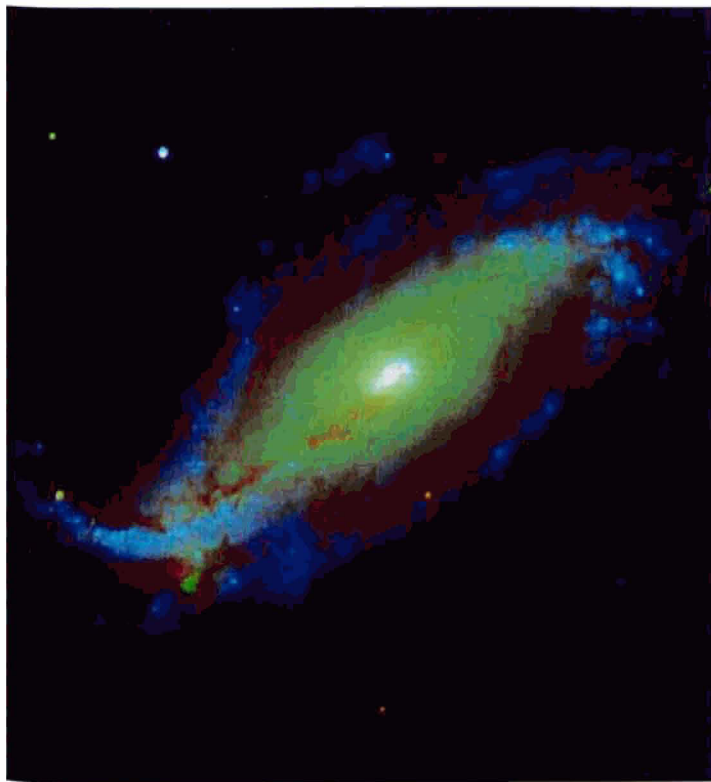

111 NGC 613 is here shown in a colour picture which was made from three CCD exposures in a way similar to that described for Plates 20–27. The nucleus is overexposed and white, the disk is green with absorption lanes along the bar, and the arms are blue. A peculiar aspect is the apparent intersection of the arms at both ends of the major axis.

112 This colour photo of NGC 613 is composed of two CCD frames, one exposed to blue light, and one to red H_α light. It shows very clearly the red emission areas, mainly along the inner edges of the spiral arms.

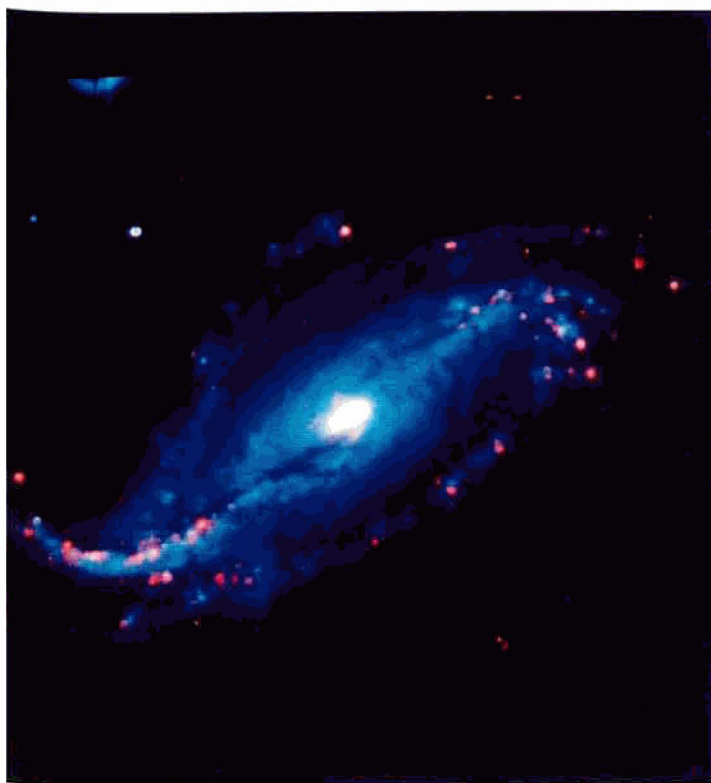

Plate 111 · 112

113 This is a “close-up” of the nucleus of NGC 613. The picture is reproduced from three CCD frames, obtained in different colours: blue, H_α (red) and in the light of the green oxygen line. The orientation is the same as on the other plates, and the green jet protruding towards the north-east is clearly seen. This jet has recently been studied at ESO. Spectral observations show that it is moving towards us at a considerable velocity relative to the galaxy. This motion cannot be explained as a rotational velocity in the plane of the galaxy. There seem to be two possible interpretations. Either the jet lies in the plane of the galaxy and we see an inflow of gas towards the centre, or the direction of the jet is perpendicular to the plane of the galaxy; in that case we see an outflow of gas from the nucleus towards the pole of NGC 613.

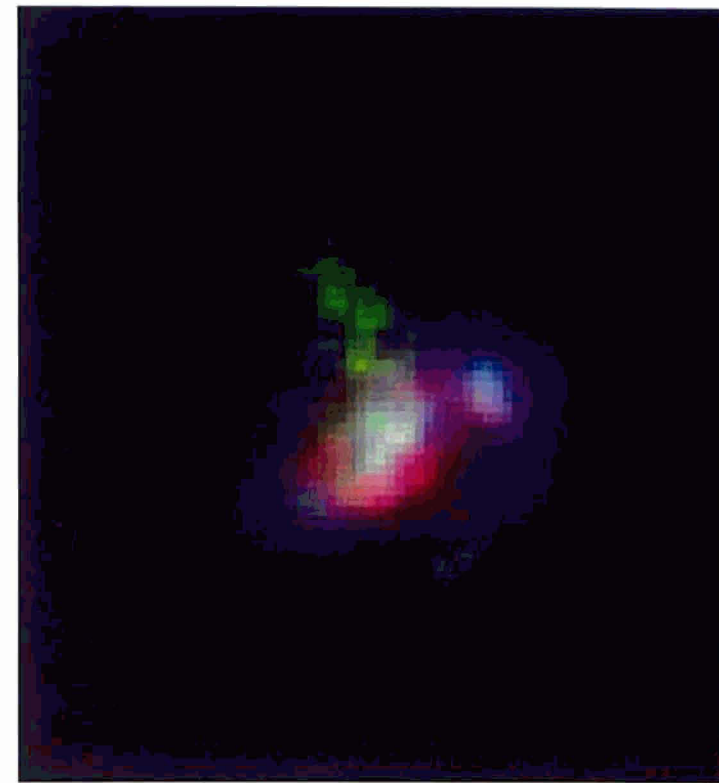

Plate 113



114 Looking at NGC 454, the immediate impression is chaos. We witness two galaxies in close interaction, and it seems that they are in the process of merging into a single object.

The origin and the evolution of galaxies is a subject that as yet is rather poorly understood. On the basis of La Silla observations it has been suggested that close encounters between galaxies, often resulting in a complete merger of the two, may play a certain role in the development of galaxies, and even of normal ones.

The upper galaxy of NGC 454 is of an early type, mainly consisting of old stars. But at its nucleus a fairly young population of stars has been detected, and it seems that a considerable burst of star formation has been triggered by the close interaction. The lower galaxy is of a late type with many emission nebulae. Its colour is very blue, from which it can be concluded that vigorous star formation is going on here as well.

We thus find that the merging of galaxies may initiate the formation of a considerable number of stars. This is not surprising, but what does it mean for the evolution of the galaxies in the long run? More stars in the end product means less gas and dust than were contained in the progenitors. More stars and less gas and dust may be equivalent to a shift towards earlier Hubble types. So, although it is unlikely that development normally occurs along the Hubble sequence, it cannot be entirely excluded that this may happen under special circumstances.

115 Searching for a galaxy that could be the end result of a recent merger, ESO 341-IG 04 has been selected as a probable candidate. It is a giant galaxy with a faint arc, which might be the remnant of an earlier spiral arm. Basically the galaxy is of an early type, mainly consisting of old stars, but here again a fairly young population of stars is found in the central area. A comparison of observations with models of stellar populations suggests that a burst of star formation took place two billion years ago. This is in good agreement with other methods that are used for dating the merging process.

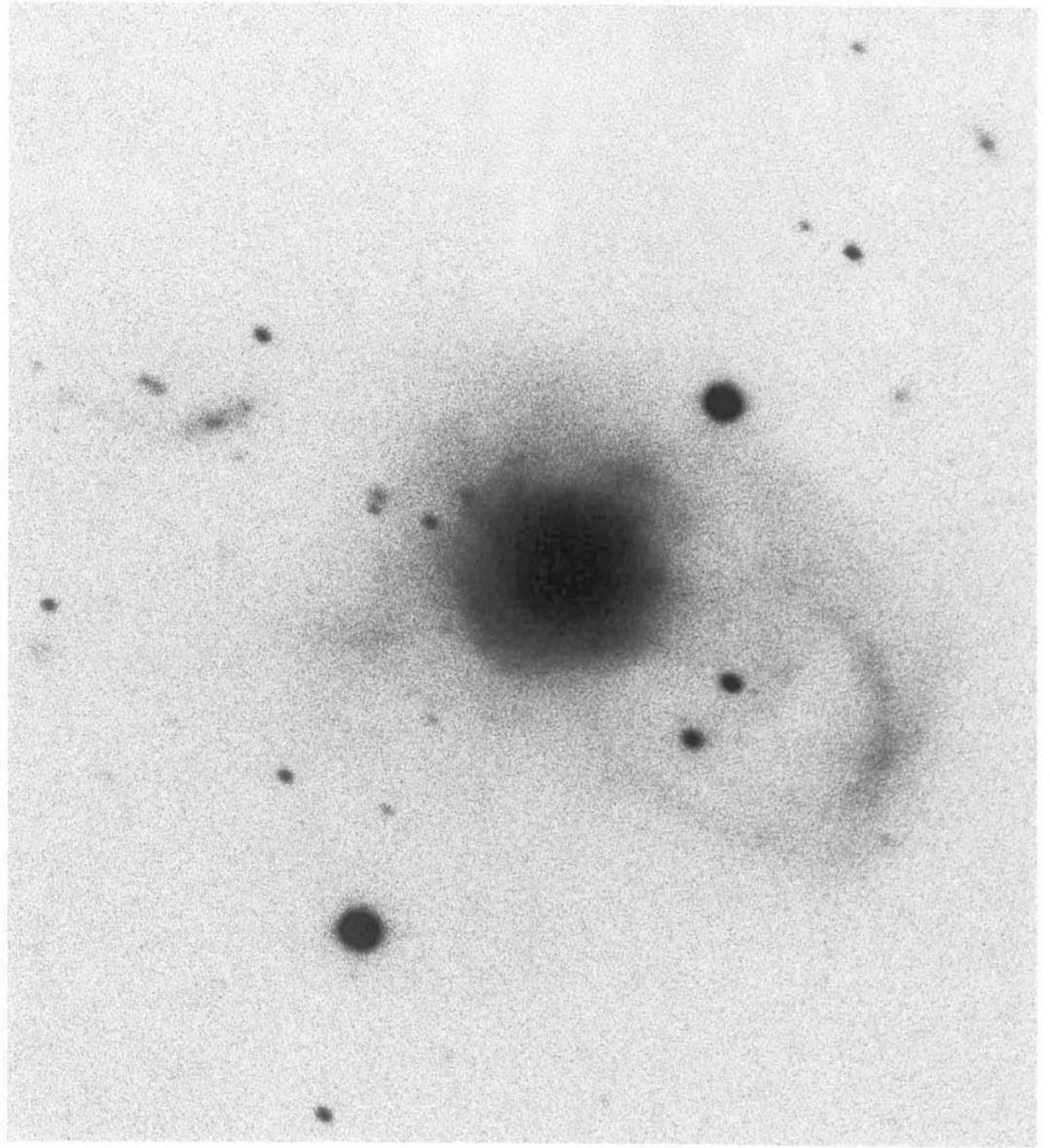



116 Far down in the southern sky, on the border between the constellations of Volans (the Flying Fish) and Carina (the Keel), lies this small group of galaxies, which was discovered in 1974 during the first ESO photographic survey of the southern sky. The central galaxy, ESO 060-IG 26, is visibly disturbed. It is flanked by the S0 galaxy ESO 060-G 27 (left) and a faint galaxy without designation (right). IG 26 has a central core and several arcs with bright knots, probably consisting of luminous stars. Although the distances of the galaxies in this system are not yet known (attempts to measure the radial velocities have so far been unsuccessful), it is probable that the strange form is the result of a near encounter between IG 26 and G 27. Under this assumption, the arcs in IG 26 are likely to form an incomplete ring. The nature of the third object is not understood. It looks like a faint nucleus, surrounded by a diffuse ring. This unusual form is apparently related to the same event that deformed the central galaxy.

117 The elliptical galaxy M 87, which is the central object in the Virgo Cluster, is a well-known example of a complex radio source with an optical jet. In this photo, M 87 appears almost perfectly circular, and in three dimensions it is probably very close to being spherical. Its constituent stars are all cold and red, and it contains very little interstellar gas. The total mass of M 87 is about 300 billion solar masses, making it the most massive galaxy yet known. At least 800 globular clusters, each containing hundreds of thousands of stars, form a halo around M 87. Some of them can be seen on this photo. The apparent diameter of M 87 is about 7 arcminutes, and the halo of globular clusters is somewhat larger, corresponding to a diameter of about 120 000 light-years.



118 M 87 exhibits a peculiar jet structure near the nucleus. It was discovered by the American astronomer Henry Curtis (1872–1942) in 1918. The overall optical image of the jet is best described as a well-aligned series of six discrete knots. In contrast to the strong emission lines seen in the nucleus of M 87, the jet exhibits a featureless continuum spectrum. The jet originates in the nucleus of M 87. Recent radio measurements have revealed that the extremely powerful radio source is contained in an area that is smaller than 12 light-days across. There is now strong evidence for the presence of a massive black hole (see Plate 119) in the centre of M 87.

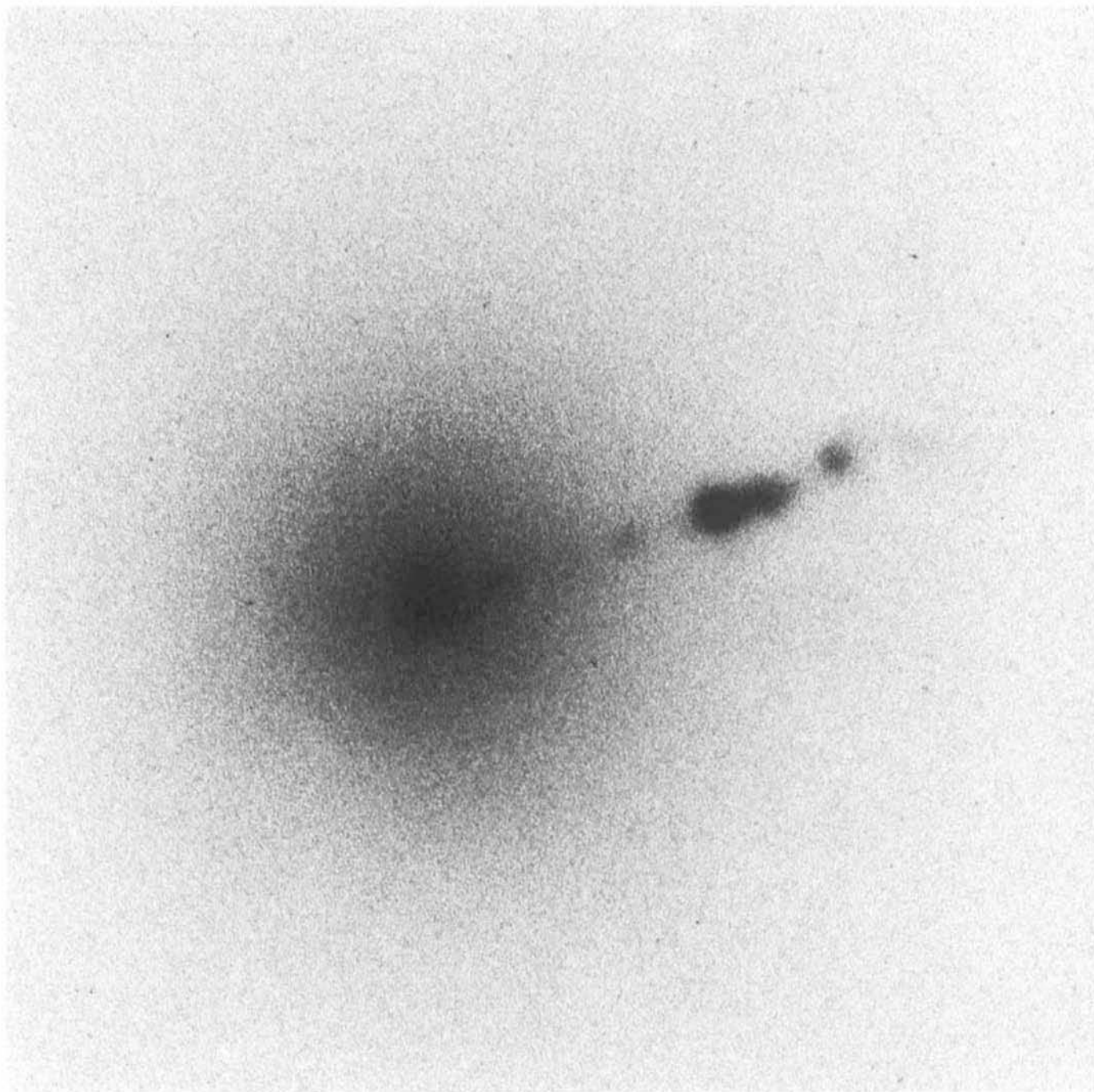

119 When *quasars* (quasi-stellar objects) were first found in 1963, they were described as an important, new component of the Universe. Until then, all objects known far outside our Milky Way Galaxy were galaxies in their own right. The discovery of the quasars as radio-emitting, star-like objects, far beyond the boundaries of the Galaxy, and in most cases far more distant than all previously known galaxies, started off entirely new areas of astronomical research.

Two characteristics of quasars are baffling: first, of course, their enormous distances, and second, their immense luminosities. If, indeed, they are as distant as their very large redshifts indicate (see Plate 6), then they must shine with an unbelievable intensity in order to be seen by earth-bound astronomers. Doubts have therefore been raised about the interpretation of quasar redshifts. Perhaps the quasars are in reality much closer and their redshifts have another, physical origin? Or perhaps the large redshifts do signify a large radial velocity, but one that is not due to the expansion of the Universe and therefore not indicative of a great distance? And if the quasars are really as distant and as brilliant as first thought, where do they get all this energy from?

Today, when more than 3000 quasars are known, most astronomers believe that they are indeed the brightest and most distant objects observable in the Universe. However, quasars are no longer thought to constitute a completely new class of objects; they are simply excessively bright nuclei of otherwise normal galaxies. In some galaxies, the nucleus apparently passes through an “active” (quasar) phase during which its brilliance increases several million times. It is likely that the energy comes from an extremely dense, collapsed body at the centre of the nucleus. This body may be a “black hole”, a small area of space that is so dense that even light cannot escape from its enormous gravitational field. Hence it cannot be seen – and therefore the name. Great amounts of energy are liberated when matter falls into a black hole and is swallowed by it.

It has taken much effort to prove that at least some of the quasars are galactic nuclei. The problem is that very few quasars are close enough to allow detection of the light from the surrounding galaxies. This photo shows an example of a quasar in a galaxy, supporting the theory mentioned. The object, ESO 113-IG 45, was first found on a photographic plate taken with the ESO Schmidt telescope in 1976. It looked like a red “star” of magnitude 13 with some “fuzz” around it. A spectrum was obtained which showed that the “star” was receding with a velocity of 13600 km/s! It was obviously not a star at all, but rather a galaxy with an exceptionally bright nucleus, at a distance of 680 million light-years. The luminosity and star-like appearance of the nucleus put it into the quasar class. Later investigations have seen this nucleus fade, and the galaxy is now better described as being of the Seyfert type, although still exceptionally bright (see also Plates 31 and 87). Similarly, most, if not all, of the closest quasars appear to be extremely bright nuclei of Seyfert galaxies.

ESO 113-IG 45, which measures about 130000 light-years across, has a few diffuse spiral arms and is accompanied by a smaller, elliptical galaxy to the south-east. In this picture, the very bright nucleus is overexposed. A few, more distant galaxies are also seen in this field, together with some galactic foreground stars.

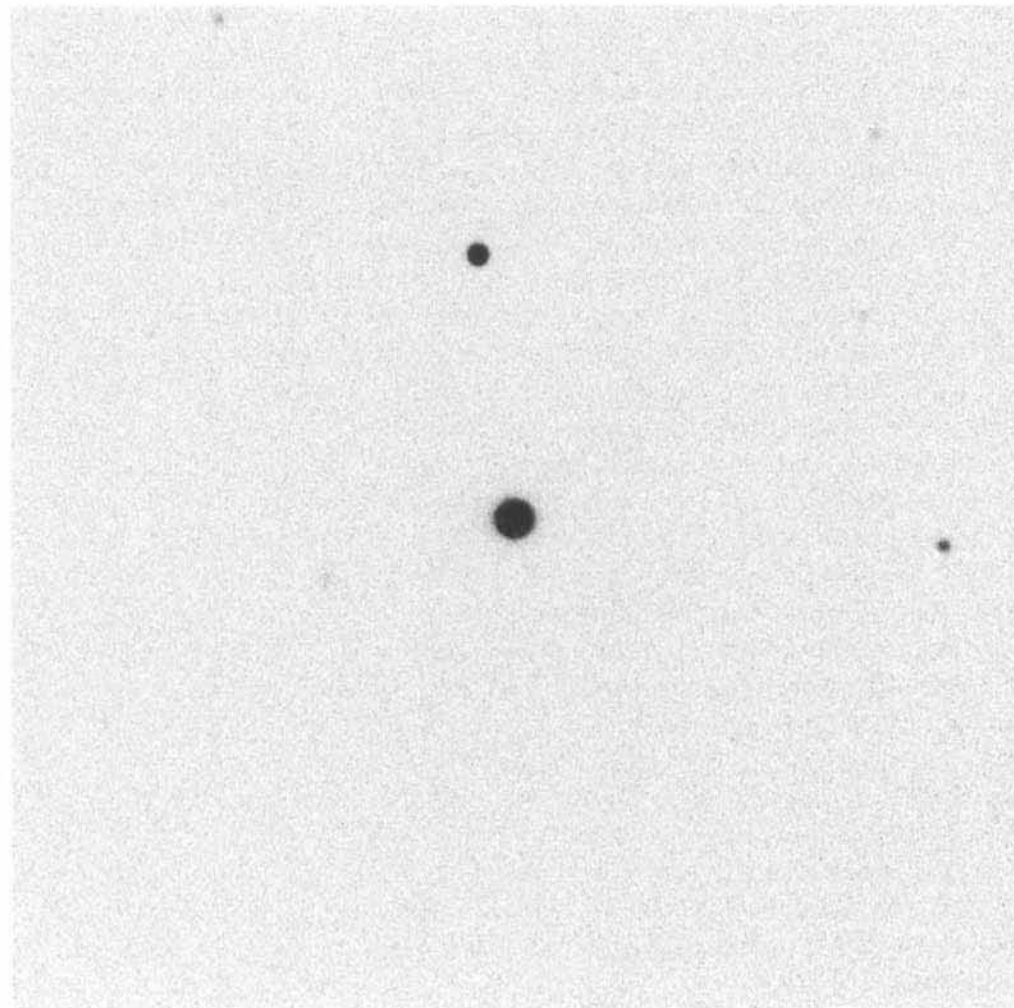
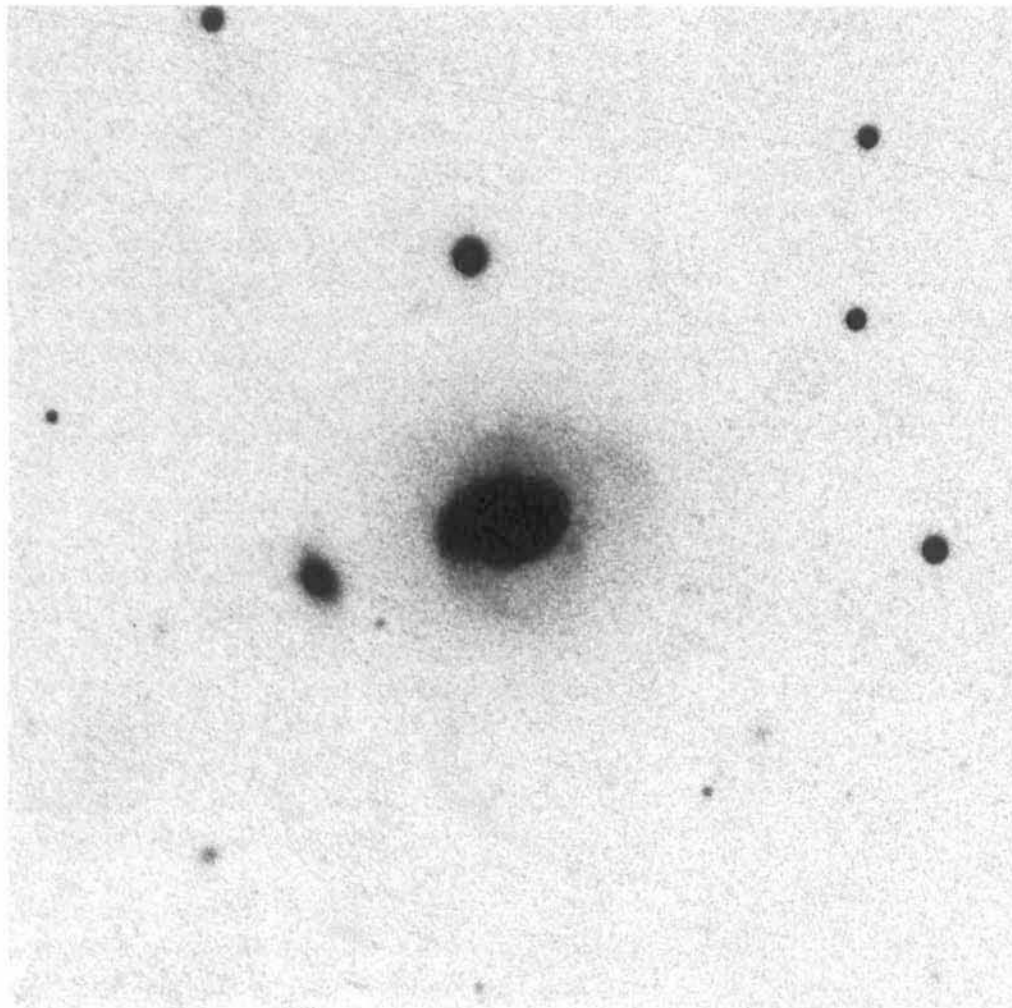

120 On this short exposure, which has the same scale as the preceding Plate, the bright object at the centre is the star-like nucleus of ESO 113-IG 45. Of the surrounding galaxy there is no trace; it is too faint to be seen here. This illustrates why more distant quasars are always seen as star-like objects. Even the most powerful telescopes cannot detect the exceedingly faint light from the galaxies in which they are situated.

The object almost due north of the quasar is a galactic star; it is star-like on both Plates. Note also the very weak, diffuse image of the centre of the companion elliptical galaxy on this Plate.

2 The Milky Way Galaxy

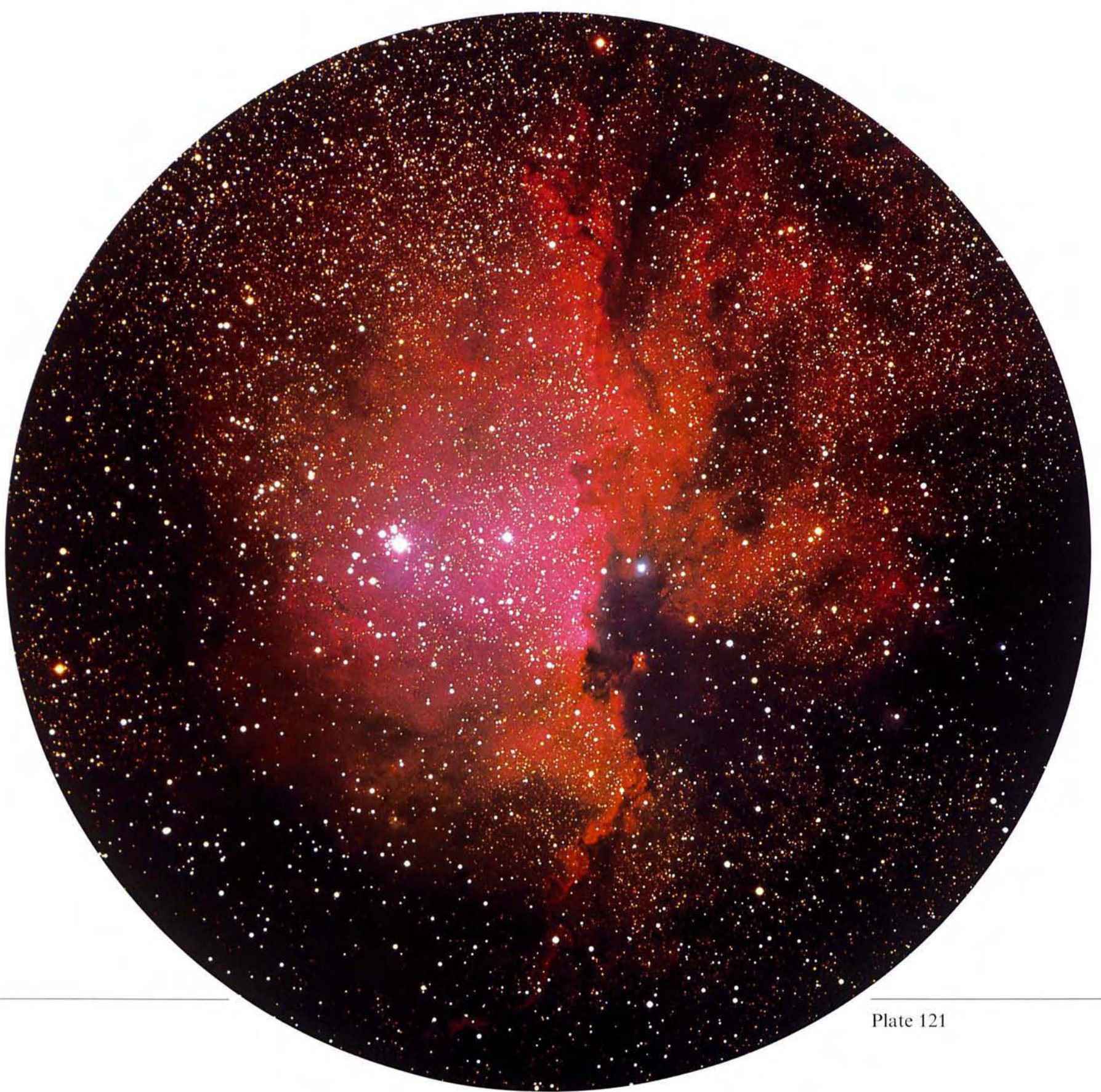

The Milky Way Galaxy is our local stellar system, the galaxy in which the Sun and the planet Earth reside. It has a curious name, which is of Greek origin, although it may have older Indo-European roots. In ancient Greece the word *Gala* ($\tau\omicron$ $\Gamma\acute{\alpha}\lambda\alpha$, milk) was used by Anaxagoras (500–428 B.C.) and the word *Galaxios* ($\acute{\omicron}$ $\Gamma\acute{\alpha}\lambda\acute{\alpha}\xi\omicron\varsigma$) by Hipparchos (died around 125 B.C.) as names for the diffuse, white band girdling the night sky, the band which we today call the *Milky Way*.

In Europe, the Milky Way has equivalent names in most languages, for instance, die Milchstraße (German); la Voie Lactée (French); la Via Láctea (Spanish); Via Lattea (Italian); Mælkevejen (Danish); Melkweg (Dutch); Mlechnij Put (Russian). Only the Swedish name (“Vintergatan”) is an exception; it means the “winter street”. This last name is well chosen for a nordic country, where the summer nights are so bright that the Milky Way can hardly be seen during those months. Contrarily, the northern winter nights are dark and long, and often offer a splendid view of the Milky Way.

121 A region of star formation in the southern Milky Way (see Plate 156).

The bright band in the sky is today called the *Milky Way*, while the *Milky Way Galaxy*, or briefly the *Galaxy*, means the stellar system as such, with everything it contains. In the Galaxy there are more than 100 billion stars and innumerable nebulae of all shapes. In earlier times, all diffuse “nebulae” seen in the sky were thought to belong to the Galaxy, but from the time when some of these were shown to be distant stellar systems similar to our own, local one, those “nebulae” were called *galaxies*. To avoid confusion, it was common to refer to them as “*external galaxies*”, but this term has now been largely abandoned. The term “*galactic*” is ambiguous. It may mean “in the band of the Milky Way”, or it may mean “belonging to the Galaxy” as a whole. Contrarily, “*extragalactic*” always means “outside the Galaxy”.

Modern observational techniques, combined with painstaking and diligent astrophysical interpretations have revealed a well-developed spiral structure in our Galaxy. It is now classified as an Sbc-type spiral galaxy and, seen from the outside, it would be fairly similar to NGC 6744 (Plate 28). The Galaxy is a good-sized spiral, although its total mass may be only half that of NGC 6744.

Our conception of our own Galaxy can be illustrated by having a closer look at NGC 6744. Let us imagine ourselves sitting in its disk. Our position is not close to its centre, but 28 000 light-years away. This would be about 40 mm on Plate 28. Let us assume that by good fortune our new position has been endowed with a dark and clear night sky. We are then able to enjoy the view of our new local milky way, which probably by and large does not look too different from the well-known Milky Way of our home Galaxy. But all the details, such as the distribution of bright stars and the constellations they form, would obviously be entirely different.

2.1 Panorama of the Milky Way

122 The present panorama covers the full circle of the Milky Way, the part in the northern sky as well as that in the southern. Actually it covers somewhat more than a full circle of 360 degrees, which is evident because part of the constellation of Orion appears twice, once at each end of the panorama. The width of the panorama is over 60 degrees. The southern Milky Way is shown in the right-hand half of the panorama, while the northern Milky Way is shown on the left. A full-size version is inserted in a pocket in the back cover, while the half-size version (Plate 122), together with Fig. 12, is shown on the following pages.

The panorama is made from eight wide-angle photographs. The camera used was a Hasselblad SWC with a 1:4.5/38 mm Biogon lens. The plate format is 60 × 60 mm, and the 56 × 56 mm, square field covers about 72 × 72 degrees. The original scale at the centre of the field is 1.5 degrees per mm, while at the edge it is about 1.2 degrees per mm. This difference in scale is due to the fact that the camera field is flat, while distances in the sky are measured along great circles on a sphere. As a result of this it is not possible to fit the eight frames together perfectly to make a continuous panorama. Only in a narrow band along the great circle of the Milky Way is this scaling effect small enough to allow a good fit. Outside this band, it is impossible to avoid a discontinuity between neighbouring fields.

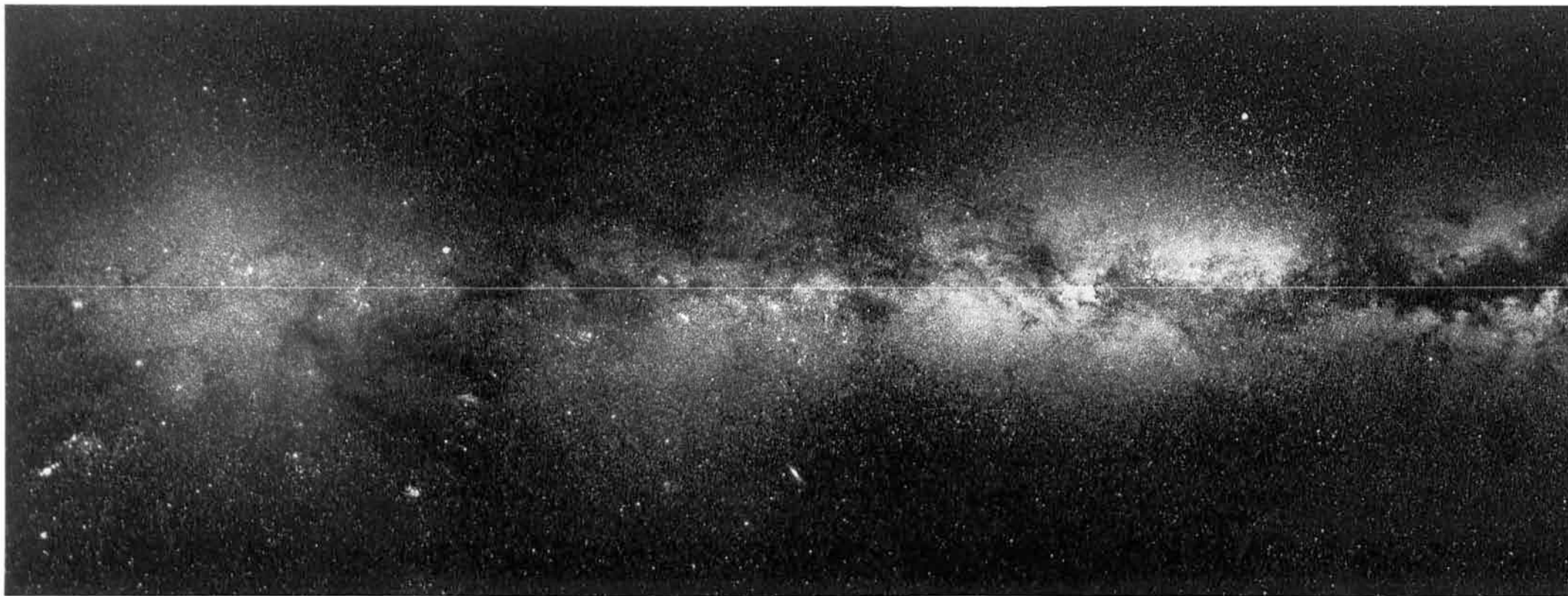
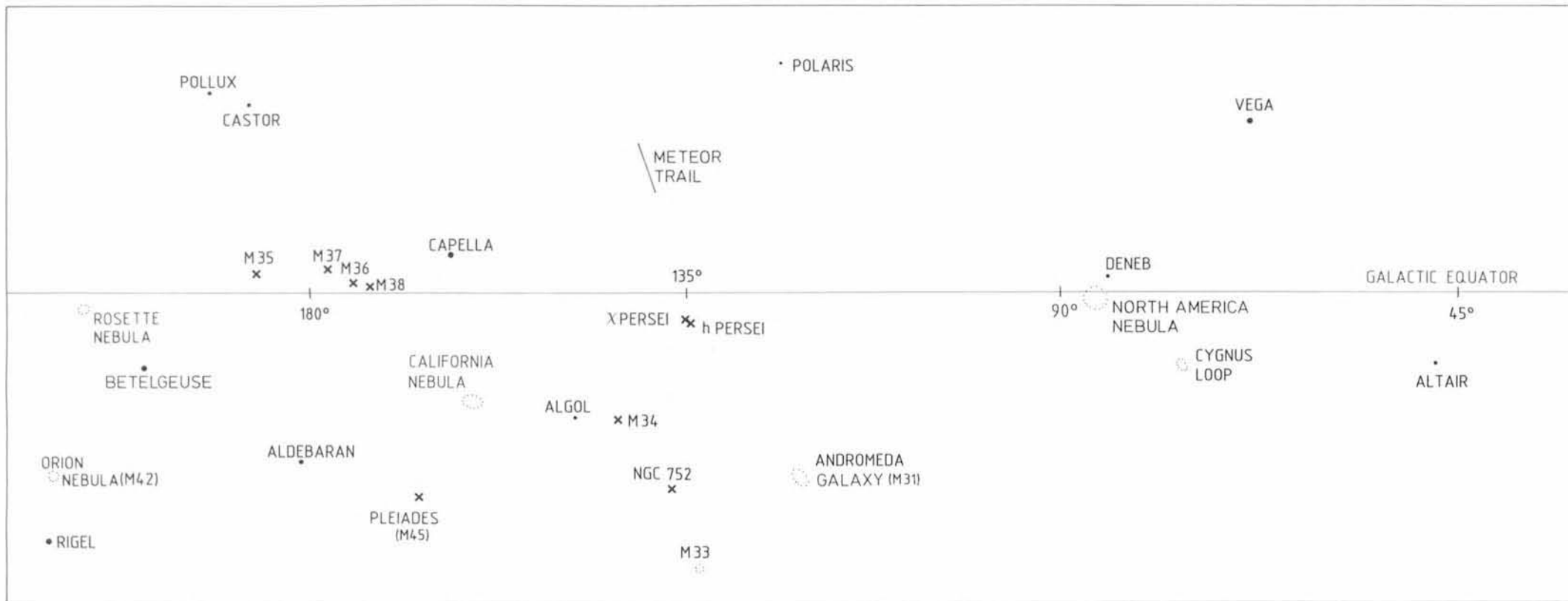

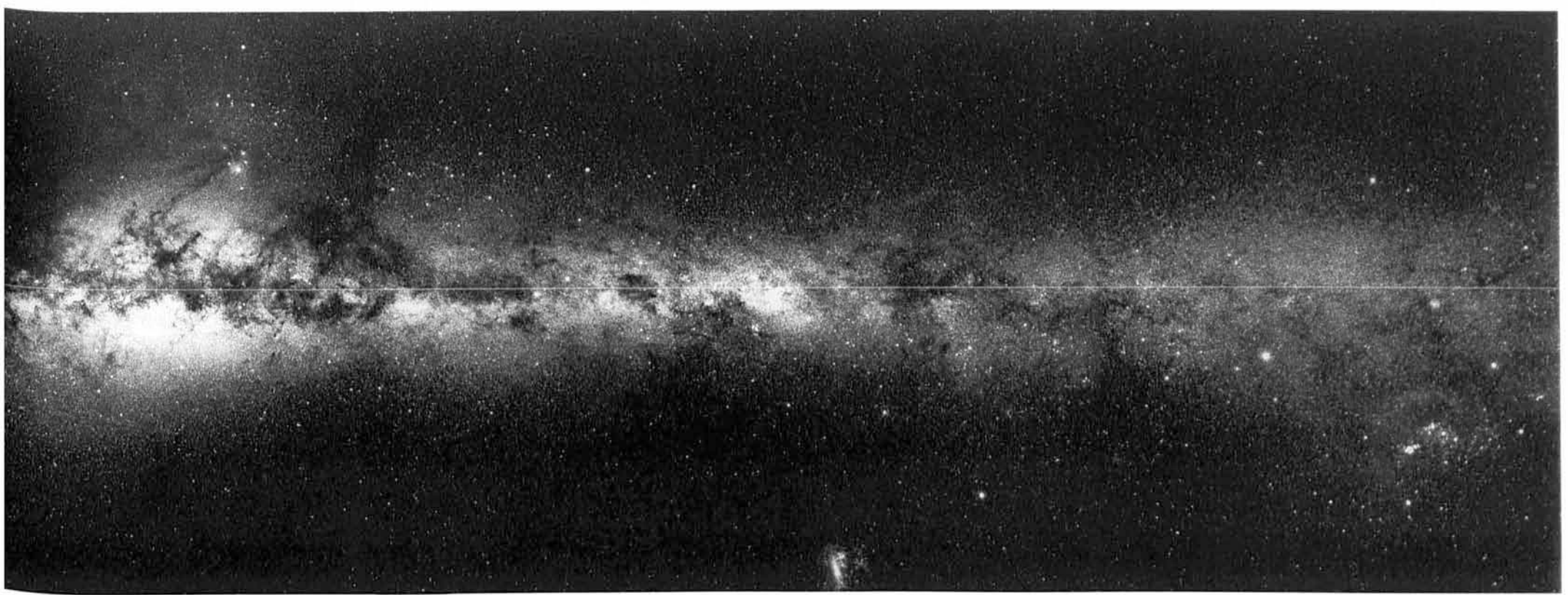
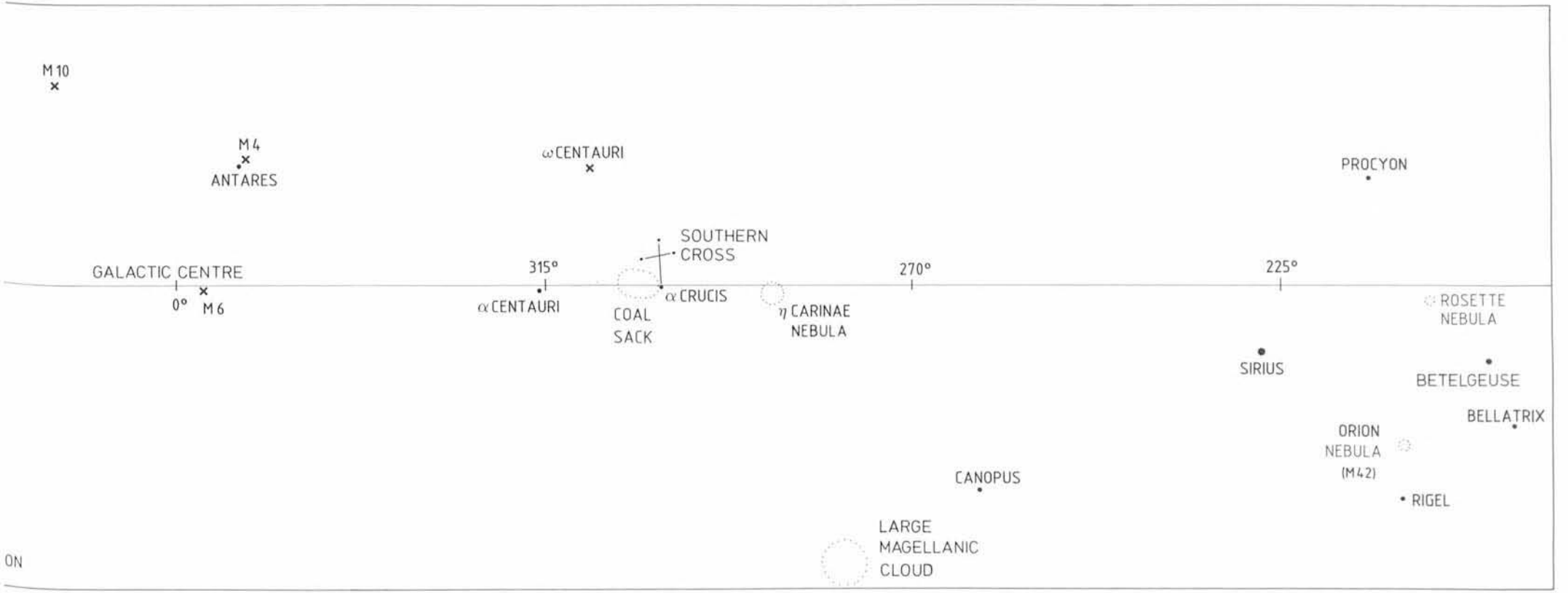

The original plates were enlarged by a factor of 4.2, and when the outermost parts of the fields were cut away, the resulting average scale of the full-size panorama became approximately 3 mm per degree on the sky. The angular resolution on the plates is close to one arcminute, which means that two faint stars separated by one arcminute will just be recognizable as two separate stars. This resolution is about the same as that of the human eye. The limiting magnitude is around 11th visual magnitude. The faintest stars visible to the unaided eye are of 6th visual magnitude, so the plates show stars that are one hundred times fainter than the faintest ones visible to the naked eye. For technical reasons, both the resolution and the limiting magnitude of this print are inferior to those of the original plates.

All fields are centered on galactic latitude 0° , that is on the galactic equator, marked with a white line on the panorama. The northern Milky Way fields were photographed in September 1984 at the Roque de los Muchachos Observatory on La Palma in the Canary Islands. Exposure times were 60 minutes and the Hasselblad camera was mounted on a 60-cm telescope belonging to the Royal Swedish Academy. The telescope motion compensated for the daily rotation of the sky, so that the camera always pointed in the same direction, relative to the sky. The southern fields were exposed at the ESO La Silla Observatory in March 1985. Here the exposure times were 90 minutes and the camera was mounted on the GPO double astrograph. The increase in exposure time was needed to reach the same limiting magnitude because the sensitivity of the photographic material used in 1985 was less than that of the material used in 1984.

Most of the light from the Milky Way comes from stars, and only a small part from emission or reflection nebulae. All along the Milky Way

the absorbing dust clouds show up as dark areas. If they were not there, we would see a fairly smooth stellar distribution with a maximum density in the direction towards the galactic centre in the middle of the panorama. Moving along the equator towards the anticentre, that is the direction opposite the galactic centre, the density would decrease smoothly. The stellar density also becomes smaller when going from the equator towards the two galactic poles.

Let us start with a brief description of the panorama in order to familiarize ourselves with the Milky Way. A more detailed survey of the southern Milky Way will be given in the following chapters. Descriptions are made from right to left, that is with increasing galactic longitude. The right edge of the panorama is at longitude 194° .

In the right-hand quarter of the panorama, a number of bright objects immediately catch the eye. First the bright stars of Orion: *Betelgeuse*, *Bellatrix*, *Rigel*, and the three stars in a row that form Orion's Belt. Just below them we find the *Orion Nebula* and, closer to the galactic equator, we find the *Rosette Nebula*, both impressive emission nebulae. On either side of the equator we find α Canis Minoris, or *Procyon*, and α Canis Majoris, also called *Sirius* or the Dog Star. Sirius is the brightest star in the sky; the second brightest, α Carinae or *Canopus*, is also in this quarter. The physical properties of these two stars are quite different. Sirius is a relatively close (9 light-years), white, giant star, which shines with the brilliance of 400 solar luminosities. Canopus is a much more remote (200 light-years), yellow supergiant with a brilliance of no less than 7000 solar luminosities. It is one of the most luminous supergiant stars known in the Galaxy. Finally, we find in this first quarter our nearest neighbouring galaxy, the *Large Magellanic Cloud*, and also the gi-

gantic galactic nebulosity complex, the *η Carinae Nebula*.

The second quarter is a very beautiful area with the *Southern Cross*, the *Coal Sack*, the galactic centre and the nuclear bulge of the Galaxy. By various methods, the distance to the centre has been determined to around 28000 light-years. In this panorama in visual light we see nothing at all of the central region, because it is completely hidden behind large amounts of dust in the galactic disk. The central bulge, however, shows up very clearly with its myriads of stars. There are especially large numbers within 20° of the centre, or 30 mm on Plate 122, but the bulge has no sharp boundary. It is best seen below the galactic disk, because above the disk the dust clouds extend far out in space. They even reach beyond the bright star *Antares* in Scorpius at a galactic latitude of $+15^\circ$.

The bright star-like object *ω Centauri* is not a star; it is a crowd of a million stars! It is a globular cluster, the brightest one of its type in the sky and visible to the naked eye. Many other globular clusters are seen in this area, for instance *M 4* and *M 10*. Altogether, more than one hundred globular clusters are known in our Galaxy. They have a distribution like that of the so-called halo stars, which occupy a nearly spherical volume, with the highest density near the galactic centre. Moving outwards from there, the density falls off about equally in all directions.

The halo stars and the globular cluster stars are of the same type; we say that they belong to the same stellar population. This is a population of old stars, which were formed early in the history of the Milky Way Galaxy, and which all have a small content of elements heavier than helium. Stars in the flattened disk, on the other hand, have all possible ages and form a population with a higher content of heavy elements. Astronomers use the term *Population I* for the

type of stars found in the thin disk, and *Population II* for the stars in the halo and in other objects, including the globular clusters.

We now pass to the third quarter and move into the northern sky. The area is dominated by three bright stars: α Lyrae or *Vega*, α Cygni or *Deneb*, which almost disappears in the bright background of fainter stars, and α Aquilae or *Altair*. Together these three stars form the well-known *summer triangle*, easily recognizable by northern observers on summer evenings. Here the band of the Milky Way is split in two by the *Great Rift* caused by a nearby dense dust cloud. Near the left end of the Rift we see the *North America Nebula*. Part of the *Cygnus Loop*, or the *Veil Nebula*, can also be seen. It is a well-known supernova remnant. The bright spot at the lower edge is not a real image, it is an optical reflection in the camera of light from the bright planet *Jupiter*, which at the time of the exposure was situated just outside the camera's field.

Moving into the fourth quarter, we first come to the Cassiopeia-Perseus area. We are now far north; the celestial *North Pole* is in the field, with the bright star α Ursae Minoris or *Polaris* close by. The area holds many interesting objects, such as the double stellar cluster *h Persei* and χ *Persei*. Like these, *M 34* and *NGC 752* are also impressive open star clusters. Close to *M 34* we find the famous variable star β *Persei* or *Algol*. Our giant neighbour in the Universe, the *Andromeda galaxy*, or *M 31*, is clearly visible, while the image of the fainter, Local-Group spiral galaxy *M 33* can still be distinguished from that of a star. In this area we also find the straight trail of a bright meteor, the only one on the panorama. Near the centre of this quarter, we find the very bright star α Aurigae or *Capella*, and further down the *California Nebula*. We shall return to the left-hand part of this panorama in Plate 124.



123 *Pardies Chart of Orion*. Ever since antiquity the constellations have carried impressive names, reflecting the divine nature of the heavens. The sense of glory is conveyed in a most beautiful way by this stellar chart, which was originally drawn by the French Jesuit and profes-

sor of mathematics, Ignace G. Pardies (1636–1673). It was published in Paris in 1674, together with five other charts. The present picture has been reproduced from a third version of the atlas, published in Nuremberg about 1700.

2.2 The Milky Way from Orion to Puppis

124 A part of the Milky Way panorama (Plate 122) is here reproduced in a negative print, showing the area of sky that includes the constellation of Orion and its impressive surroundings. The great hunter Orion is an easily recognizable constellation in the Milky Way. Since it extends on both sides of the celestial equator, it is known equally well to southern and to northern observers. The galactic and the celestial equators intersect at a steep angle, east of Orion, in the constellation of Monoceros (the Unicorn).

When we look in that direction, the centre of our Galaxy is behind us. The galactic anti-centre lies in Auriga at 180° galactic longitude.

In this area of Auriga, Taurus, Orion, Monoceros and Gemini, the galactic disk appears broad, due to the presence of branches of a spiral arm of the Galaxy. The nearest branch is called the Orion arm, and much of the material seen in the area forms part of that arm. The Sun is situated between two spiral arms, but fairly close to the Orion arm.

Remarkably large, but faint, nebulae in Orion are *Barnard's Loop* and the λ Orionis nebula, which are clearly shown on the next Plate. The brightest nebulae in the area are the *Orion Nebula*, M 42, and the *Rosette Nebula*. Over a dozen open star clusters are marked on Fig. 13. The Seven Sisters are familiar to all stargazers. This cluster is also called the *Pleiades* or M 45, and is a fairly young cluster of stars, still embedded in part of the dust cloud from which they were

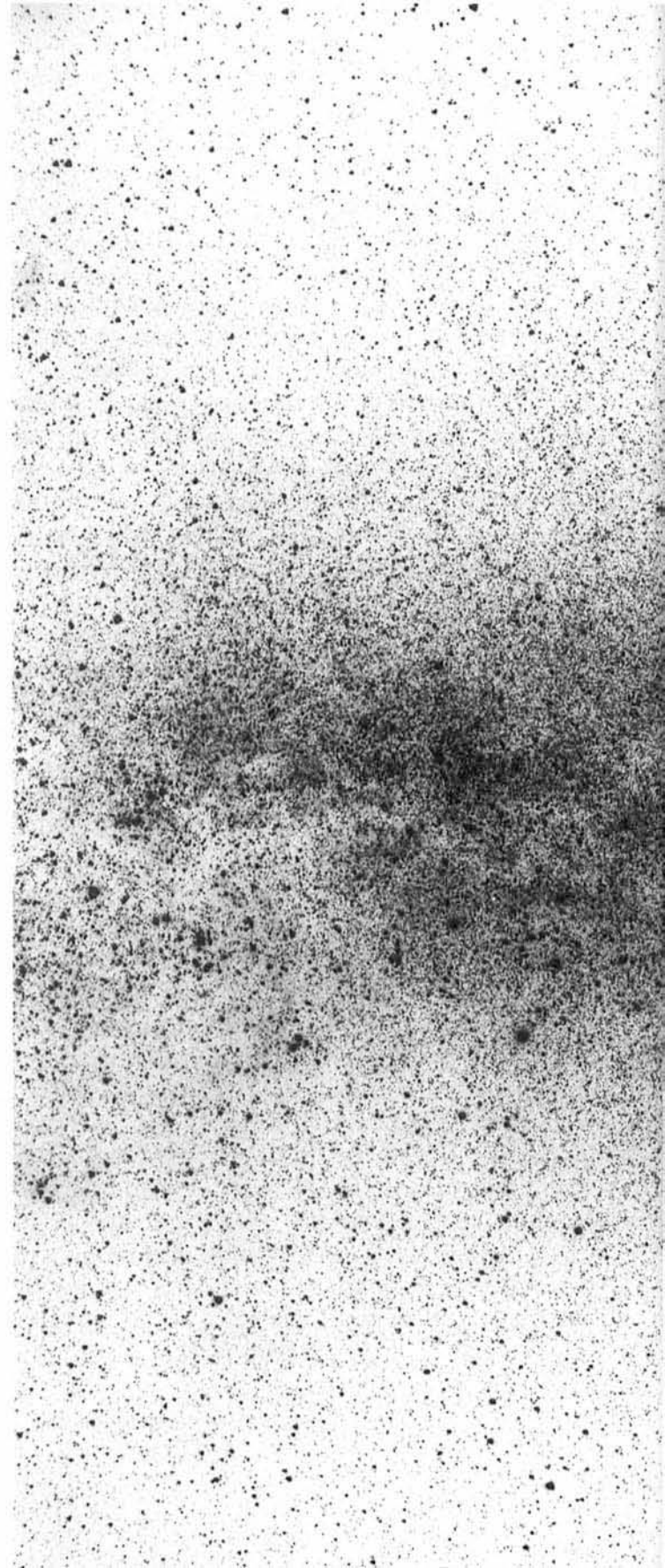
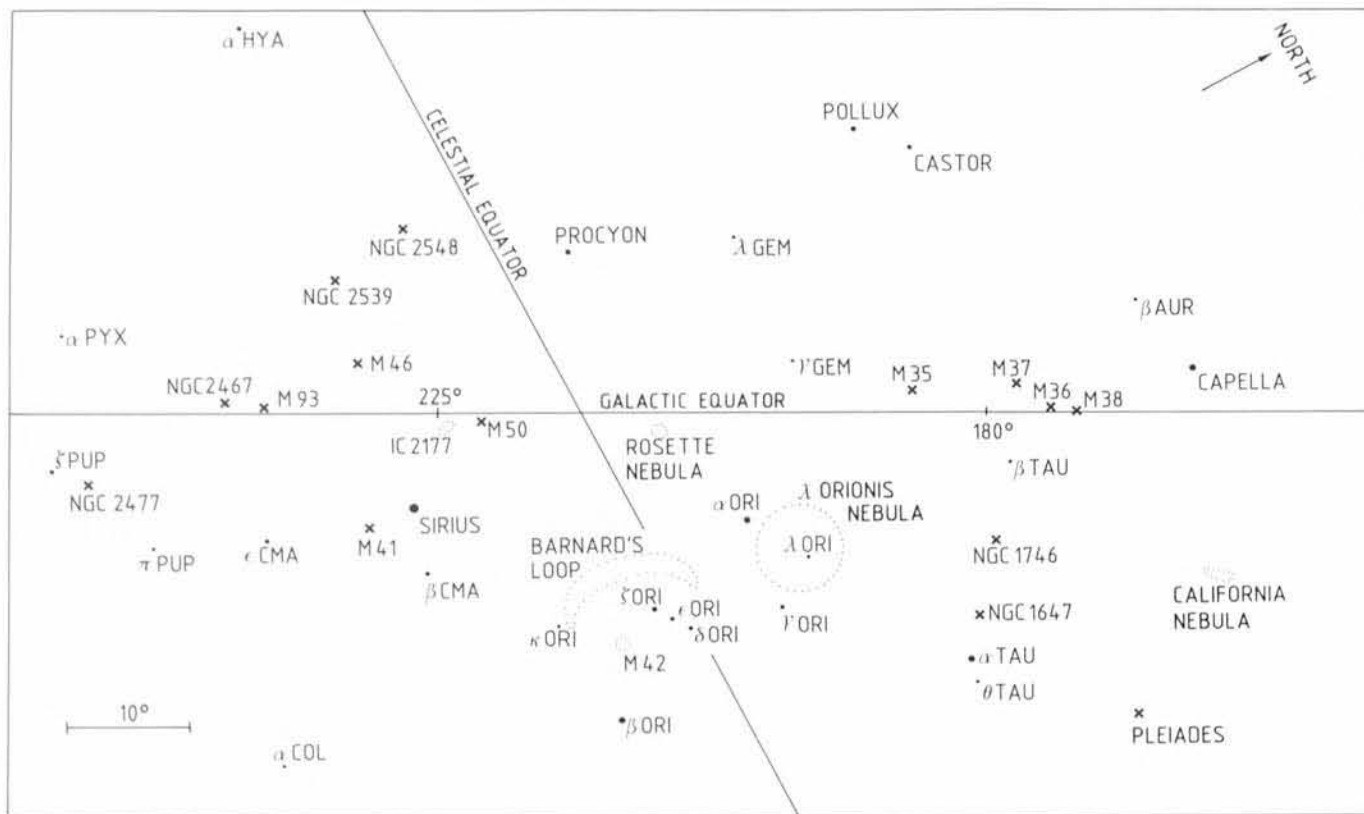

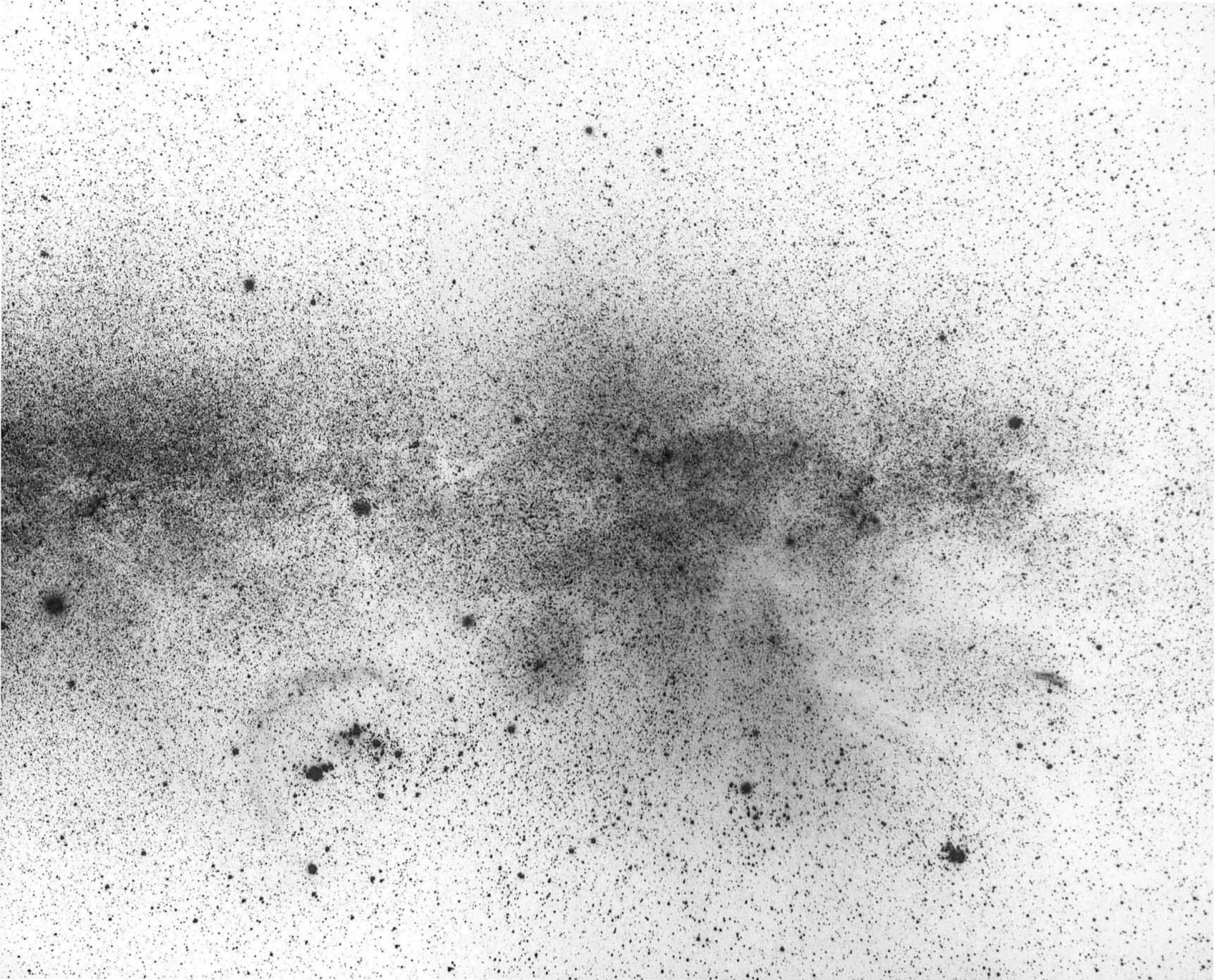



born. The Pleiades are only 400 light-years away, but another star cluster, the Hyades, is still closer. The Hyades are so close to us that its member stars are spread out over a large area of the sky, and it is not immediately obvious that they make up a cluster.

The Hyades are a perfect example of a moving cluster, and its centre is near the binary star θ Tauri. All its stars move through space in parallel orbits, and all travel with very nearly the same velocity of 43 km/s. When seen in perspective, as from our standpoint on Earth, they all appear to move towards a particular point in the sky, the so-called “convergent point” for the parallel orbits. Since the Hyades’ stars are distributed over a large area of sky, this convergent point can be determined with good accuracy. Combined with basic geometry, this allows us to make a rather precise distance determination for the Hyades. The method is called the *moving-cluster method*, and from accurate velocity mea-

surements it is possible to determine distances of individual member stars. In this way, the average distance of the Hyades’ stars has been found to be about 150 light-years. This accurately measured distance plays a very important role in scaling other distances in the Galaxy, as well as the much larger distances to other galaxies. The distance scale of the Universe itself is to a considerable extent based on the distance to the Hyades, as determined by the moving-cluster method.

125 The Orion complex of ionized hydrogen is most clearly seen in this H_α exposure. The main components are Barnard’s Loop, the bright arc to the left, and the λ Orionis Nebula, which is the ball-shaped structure at the top. It is believed that the fainter nebulosity to the right, part of which is seen as a line running north-south, is another result of the event that formed Barnard’s Loop. The Loop also emits ultraviolet radiation and, on the convex side of the visible loop, a corresponding, but more massive loop of neutral hydrogen has been detected by radio astronomers.

The picture that emerges from the available observations is one of a large shell of hydrogen. Most of the hydrogen is in the neutral state, but the inner side of the shell is ionized. Inside the shell there is a cavity that contains a hot, low density, ionized gas, and here we also encounter a group of O and B-type stars, the so-called *Orion OB1 association*. These stars are very hot and radiate sufficient energy in the form of ultraviolet light to keep the hydrogen in Barnard’s Loop and the related structures ionized.

But the stars of the Orion OB1 association can hardly be responsible for the creation of the Loop. Neither their radiation, nor their stellar winds at an earlier epoch could have provided enough energy for that. Most probably the Loop was formed by a sequence of supernova explosions, which started some three million years ago. The enormous amount of power thus released could create the shell, which today is still expanding with a velocity of 10–20 km/s. In the direction of the disk of the Milky Way Galaxy, the shell would soon collide with the denser gas of the disk and a deceleration would take place. This is where we find Barnard’s Loop. In the opposite direction the shell has continued to expand much more freely.

The nebula around λ Orionis could well be the result of a similar event, but it must be more recent since the nebula is so much smaller.

Observations have shown that the ultraviolet radiation from Barnard’s Loop is caused by *scattering* of stellar light. Dust particles in the gas reflect starlight, and the efficiency of this reflection is highest in the ultraviolet spectral region. That is exactly the wavelength range where the intensity of the radiation from the hot O and B stars is very high.

Recently, an even more extended, faint, ultraviolet reflection nebulosity has been detected in this area. It has an extent of more than 30 degrees and is therefore much larger than Barnard’s Loop.

126 This colour photo of the southern part of the constellation of Orion was exposed for only 20 minutes. Faint nebulosities like Barnard’s Loop do not come out very well, but the exposure is quite suitable for showing the colours of the stars. The colours of relatively faint stars are seen best – many of the brighter ones are overexposed and therefore just appear white.

For our initial look we select three equally bright stars, HR 1648, HR 1618 and HR 1619, which happen to form an equilateral triangle. They are reddish/yellow, yellow/white and blue respectively. From spectroscopic studies, we have found that their surface temperatures are about 2600, 5250 and 11900 K. In relative terms, red stars are cool and blue stars are hot. For comparison, the Sun has a surface temperature of 5800 K.

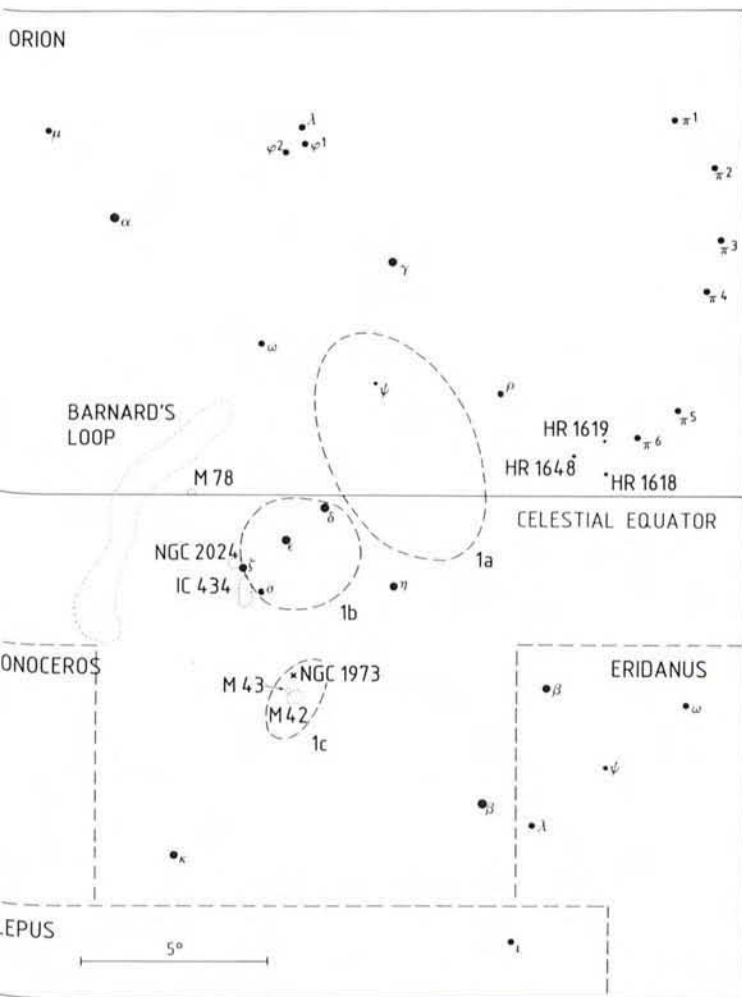

Fig. 14



A closer inspection of the photo reveals a large number of blue stars, which belong to the Orion OB1 association mentioned in connection with Plate 125. An *association* is a loose collection of stars, in which the stars do not remain gravitationally bound for a long time as do the stars in clusters. The B-type stars are massive, hot and luminous and they have a relative short life-span. The O-type stars are even more massive, hotter and much more luminous. Their lives are also shorter.

The Orion OB1 association can be divided into sub-associations, normally called 1a, 1b, and 1c (as indicated on Fig. 14), and 1d, which is the small sub-association in the Orion Nebula, M 42 and M 43. The ages of the stars in these sub-associations have been determined at around 10, 6, 4, and 1 million years, respectively. It is apparent that the smaller the extent of the sub-association, the younger it is.

The bright star *Betelgeuse* or α Orionis is red, and its surface temperature has been measured as 3450 K. It is a supergiant, which radiates no less than 50 000 times as much energy as the Sun. But how can a star that is cooler than the Sun radiate so much energy? Only one explanation is plausible, it must be much bigger than the Sun. In fact, the diameter of Betelgeuse is 600 times that of the Sun. This star is much larger than the diameter of the Earth's orbit around the Sun, and is even bigger than the orbit of Mars. It is indeed a supergiant!

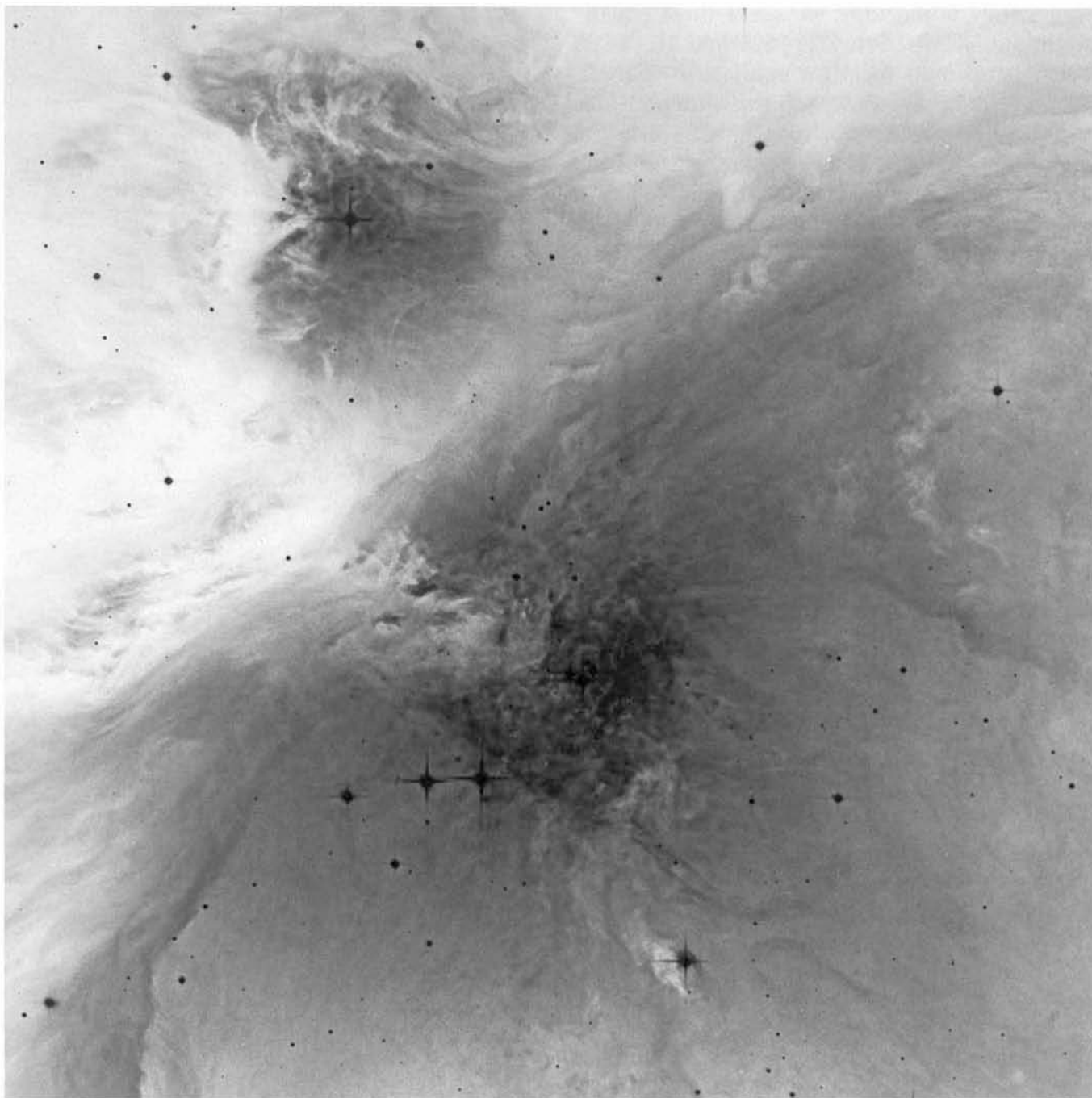

127 This is the central part of the Orion Nebula, which has two Messier numbers, M 42 and M 43. Due to its relatively moderate distance (1600 light-years) it is one of the brightest H II regions in the sky, and it is certainly the one that has been most intensively studied. And yet our actual understanding of its physical nature is still somewhat fragmentary.

The heart of the Orion nebula is the *Trapezium*. This is the quartet of stars θ^1 Orionis A, B, C and D. At the same time they are the central objects of the Orion OB 1d sub-association mentioned before (Plate 126). θ^1 Orionis C is the most prominent star. It has a surface temperature of 40000 K, a radiative power equal to 400000 Suns and most of its radiation is emitted in the ultraviolet part of the spectrum. The other Trapezium stars and other stars in the sub-association 1d, like θ^2 Orionis A and B, also in M 42, as well as NU Orionis in M 43, contribute to the strong ultraviolet radiation in this region. These stars are indicated in Fig. 15.

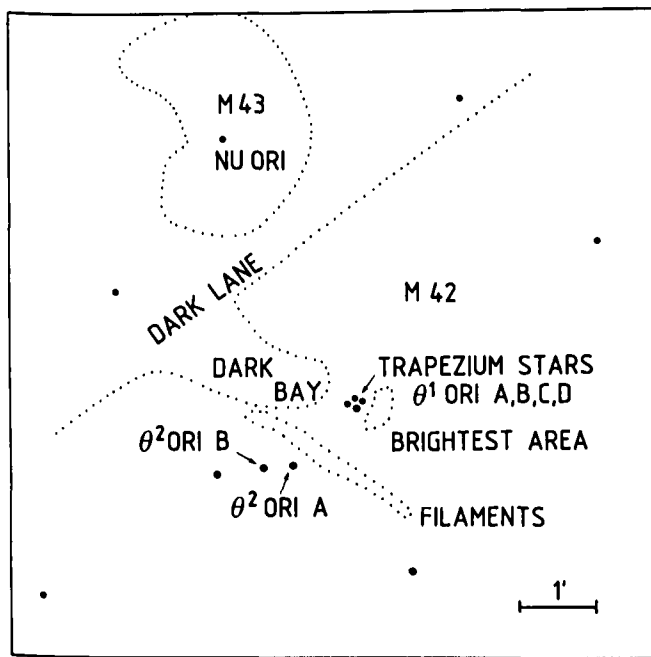

Fig. 15

By means of infrared observing techniques it has been possible to look behind M 42, where a large and very massive, cold interstellar cloud was detected. The core of the cloud is a source of strong infrared radiation. Around this compact core there is a dense molecular cloud which is again surrounded by a rather dense zone of neutral gas, as shown schematically in Fig. 16. The relative motions along the line of sight are also indicated; they are important for the astrophysical interpretation of these phenomena.

The cold cloud is moving in the direction of the Sun at a velocity of 9 km/s. The Trapezium stars recede at 11 km/s, and on the average the ionized gas of M 42 moves towards the Sun at 2 km/s. From these basic measurements astrophysicists have arrived at the following plausible model:

At the border zone between neutral gas and ionized gas, the neutral gas is illuminated by the strong ultraviolet radiation from the Trapezium

stars. The cold neutral gas is heated and ionized. The hot, ionized gas escapes from the cold surface of the cloud and flows outwards past the Trapezium into a region on the front side of M 42, where the density and the pressure is much lower. This process may have started shortly after the formation of the Trapezium stars, about one million years ago, and it may continue for millions of years, or as long as the stars can provide the necessary ultraviolet radiation power. The life of the Orion Nebula is not determined by the size of the cold cloud; it can continue to provide gas for a long time since its mass is estimated at more than 100000 Solar masses. On the other hand, the influence of the Trapezium stars may trigger a new burst of star formation within the cloud, resulting in the creation of a new association of O and B stars. Thus, there may well be a new, and possibly much bigger, nebula shining in Orion a million years or so from now.

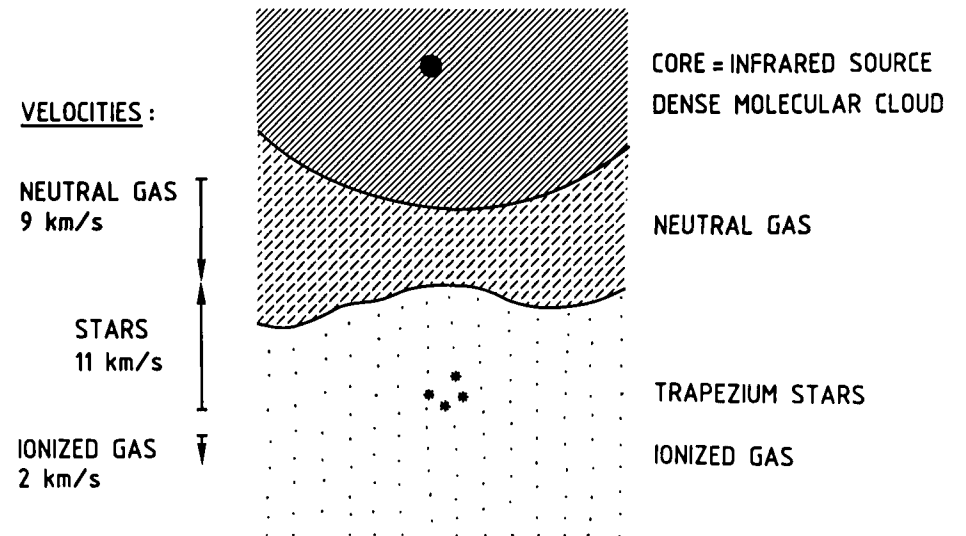

Fig. 16



128 The Orion Nebula in the light of H_{α} is an impressive sight indeed. The photo gives a good impression of the streaming of luminous gas, mainly in the direction towards the observer, but with many whirls and swirls.

129 Just south of the Orion Nebula we shall look at a newly detected phenomenon, connected with the formation of a new star.

In recent years much attention has been given to the formation and early evolution of low-mass

stars. This is partly because young stars have been found to be associated with a number of fascinating and unexpected phenomena, and partly because these studies yield new insight into the birth of our own Sun and our Solar System.

Young stars are normally found in regions of dark clouds, many of which contain large amounts of simple, organic molecules. In clouds with active star formation, we often encounter additionally the so-called *Herbig-Haro* objects. These are tiny nebulae with a knotted structure and emission line spectra. They are named after the American astronomer George Herbig and the Mexican astronomer Guillermo Haro, who first called attention to these objects in 1950. Radial-velocity and proper-motion measurements of Herbig-Haro objects have shown that they often have very large velocities, up to 400 km/s, in directions away from nearby young stars. The advent of highly sensitive CCD detectors has allowed us to study in detail the relationship between young stars and Herbig-Haro objects.

The plate shows a deep CCD image of the region around a Herbig-Haro object, which is the bright nebula in the lower part of the image. A striking linear feature, a jet, is seen to emanate from a faint young star in the upper part. The jet can be followed at a very low light-level, all the way back to the star. The total length is about 26 arcseconds, which, at the distance of the Orion Nebula, corresponds to about one fifth of a light-year. The main body of the jet consists of a number of knots. The radial velocity of the jet is 60 km/s towards us.

A likely explanation of these phenomena is that a narrow beam of hot gas is escaping at supersonic speed from the young star. Because of high-velocity collisions in this gas stream, the gas is visible as a clumpy jet. While moving away from the star, the gas cools and eventually be-

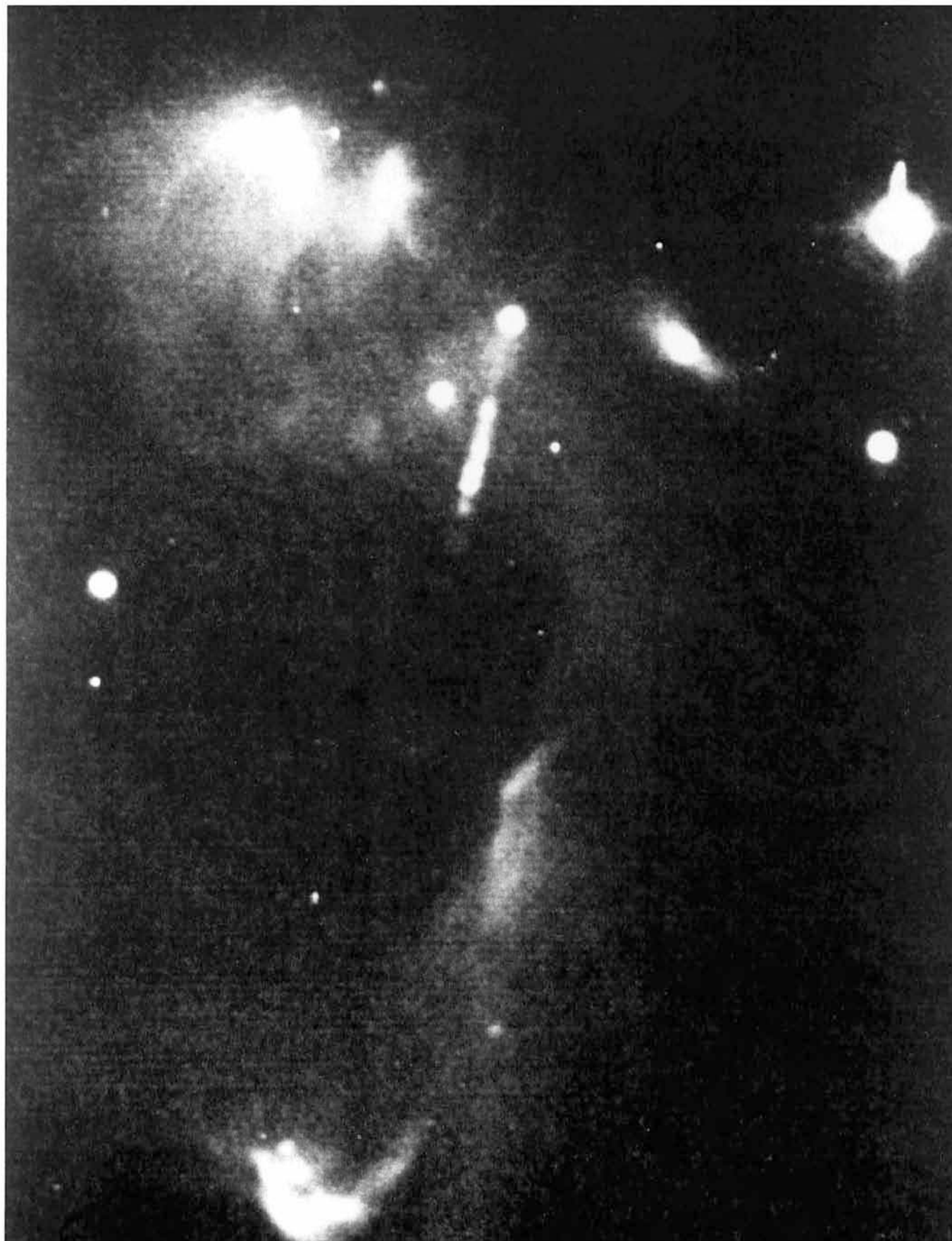

comes invisible. It does, however, still continue its outward movement, and at the location of the Herbig-Haro object it rams into the surrounding medium, creating the luminous region. In this view, Herbig-Haro objects are "shock" regions where outflowing material from young stars is pushing its way through the interstellar medium. Such outflows are obviously collimated in regions very close to the stars. Observations with radio telescopes at millimetre wavelengths have revealed dense disks of material around the young stars, lying at right-angles to the outflow direction. These disks are remnants of the clumps that initially created the young stars, and the outflows are probably formed by strong stellar winds from young stars, channeled into high-velocity beams of gas by the dense disks. The innermost regions of such disks may eventually create new planetary systems.

130 *The Horsehead Nebula* is one of the most famous objects in the sky. It is at the edge of IC 434, an otherwise not very impressive H II region, which is ionized by radiation from σ Orionis. σ Orionis is seen on Plate 126 below Orion's Belt, while here it is way outside the field to the right. Due to the low angular resolution, Plate 126 does not show that the star is in fact a multiple system of luminous O and B type stars, similar to the Trapezium (see Plate 127), but even more compact.

The birth of the σ Orionis stars, probably a few hundred thousand or a million years ago, caused a drastic change in the cloud in which they were born. Strong ultraviolet radiation and stellar winds from the stars led to evaporation of some of the dark material in the cloud. A large cavity was excavated, within which tenuous, but luminous, material now constitutes the IC 434 nebula. The rim of this nebula extends from top to bottom in the photo. From here



streaks of luminous material point roughly in the direction of σ Orionis.

The original dark cloud contained several dense cores of dust and molecules. The Horsehead Nebula is such a core that is now being isolated. It is under attack by radiation and stellar winds. This is clearly illustrated by the sharp edge outlined by a bright rim on the side of the Horsehead that is nearest to σ Orionis. Due to its high density, the dark cloud is able to withstand the attack, at least for some time, and possibly long enough to outlast the σ Orionis stars.

The Horsehead is a *cometary globule* in the process of formation. Some of these interesting objects are shown later (Plates 135–137). Astronomers in several places, including La Silla, have in recent years started a lot of new research on such globules, which have been shown to be the birth-places of low-mass stars. Such a young star is seen in a small nebulosity, embedded in the upper right-hand corner of the Horsehead.

The star has not yet passed its embryonic stage. At this early stage of their lives, stars usually hide away somewhere deep inside dark clouds where they cannot be observed with optical telescopes. The discovery of a star like this one in the Horsehead is therefore interesting. Here, the series of events leading to the formation of a new star may be followed by continued observations.

131 The H II nebula NGC 2467 is at a distance of 13 700 light-years, and is less studied than the Orion nebula. There is a small cluster of stars inside NGC 2467, and around it we find the stars of the Puppis OB2 association, which are quite dispersed. The age of the association has been determined at 2 million years, but its relation to the cluster and the nebula NGC 2467 is not entirely clear.



2.3 The Milky Way from Vela to Carina

132 From the anticentre we have now gone half-way along the Milky Way in the direction of the centre. In the old days, the main constellation in this region of the sky carried the name of Argo Navis, the Ship Argo, which was used by the Argonauts on their epic voyage to Colchis. This constellation proved unwieldy, and was later divided into three: Vela (the Sail), Puppis (the Stern) and Carina (the Keel). At 270° galactic longitude in Vela we are looking at right-angles to the centre-anticentre line at an area between two spiral arms, which may not appear very interesting. The area, especially the upper part, is covered by dark clouds, but the absorption must be moderate because myriads of faint stars and several open clusters are visible.

But here also we find exciting objects. If we study a wide-angle photograph, preferably obtained in the light of H_{α} , the very extended *Gum Nebula* becomes visible. Or we may look at a long-exposure photograph, when many so-called globules show up, several of which are connected with the Gum Nebula. We may also enjoy the beautiful view of the Vela Supernova Remnant. But let us first have a look at one particular star in the field, γ Velorum (Velorum is the Latin genitive of Vela).

γ Velorum is the brightest star in Vela, and it is a remarkable star. It was known as Al Suhail al Muhlif (the Suhail of the Oath) to the Arabs. The first observers who looked at it through a spectroscope admired its beautiful continuous spectrum, superimposed on which were broad emission lines of various colours. Very poetically, they called it the "Spectral Gem of the Southern Skies". It is a multiple star, probably with 5 components, but there may well be more.

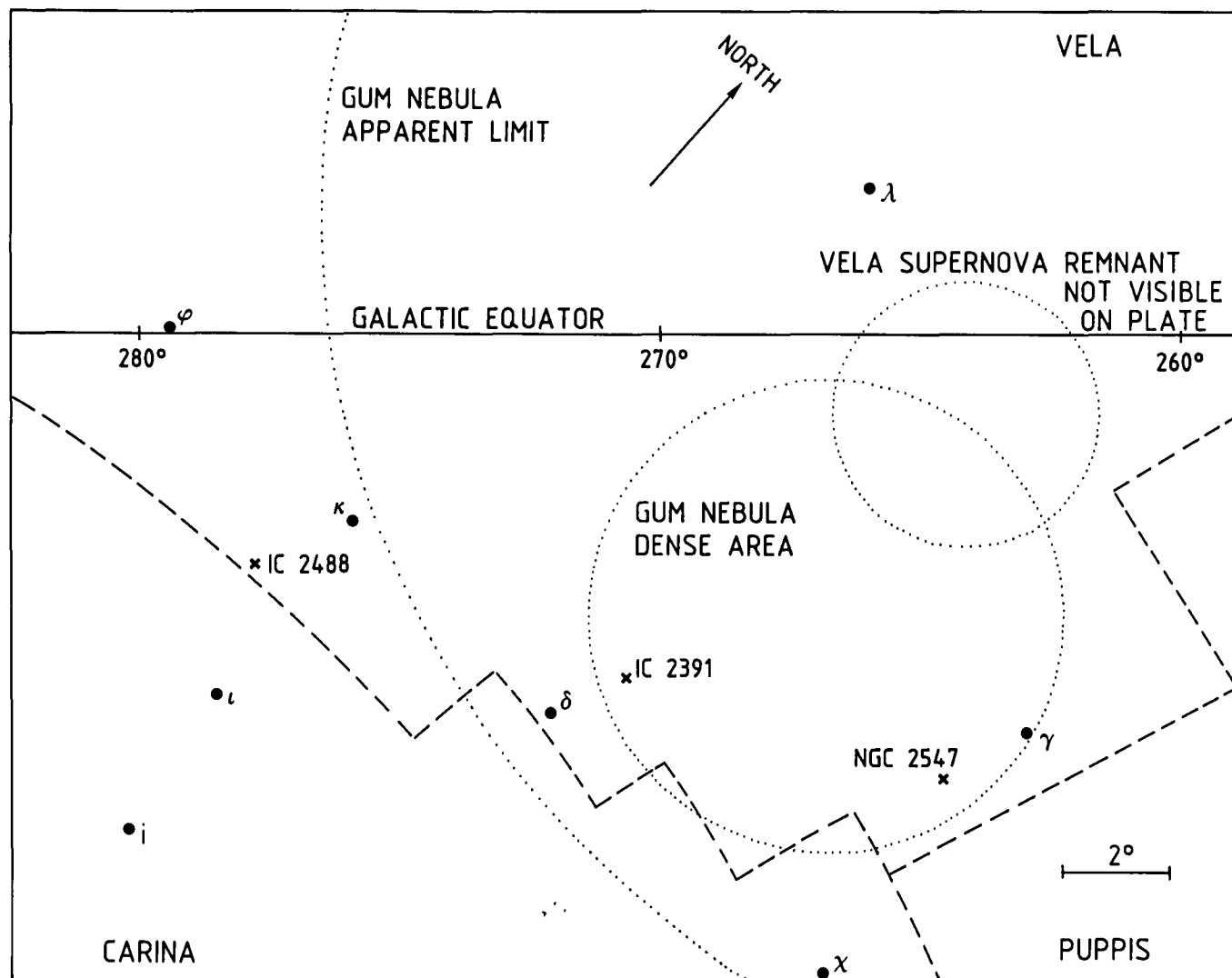

The three main components are γ^1 , a blue sub-giant, and the two stars comprising γ^2 , a close double star consisting of a famous, so-called Wolf-Rayet star, and an O-type blue star. Wolf-Rayet stars are named after the French astronomers C. Wolf (1827–1918), and G. Rayet (1839–1906), who discovered this class of stars in 1867.

The γ^2 Velorum system is the brightest, and therefore presumably the nearest, binary system with a Wolf-Rayet component. The orbital motion has been studied spectroscopically; a full revolution lasts 78.5 days, and the masses of the Wolf-Rayet star and the O-type star are around 20 and 38 solar masses, respectively. Wolf-Rayet stars are high-luminosity stars with extended envelopes of material, which is being pushed away by vigorous stellar winds. The star in γ^2 Velorum



is 15000 times as luminous as the Sun, and its surface temperature is more than 30000 K. Its companion, the O-type star, is also very hot (36000 K) and luminous. The two stars radiate much of their energy in the ultraviolet spectral region. As we shall see, this plays an important role in the evolution of the Gum Nebula (Plate 134).

133 This is the Milky Way in Carina and the adjoining regions of Vela, Centaurus, Crux (the Cross) and Musca (the Fly). As in Orion, we encounter here a nearby spiral arm of the Galaxy. It is appropriately called the Carina arm, and it extends along the line of sight. The area is dominated by the η Carinae Nebula, NGC 3372, which is the most luminous H II region known in the Milky Way. In Carina there are also fainter emission nebulae, and in Centaurus we find a complex of nebulae around the cluster IC 2948. The field is rich in open clusters, some of which are very bright.

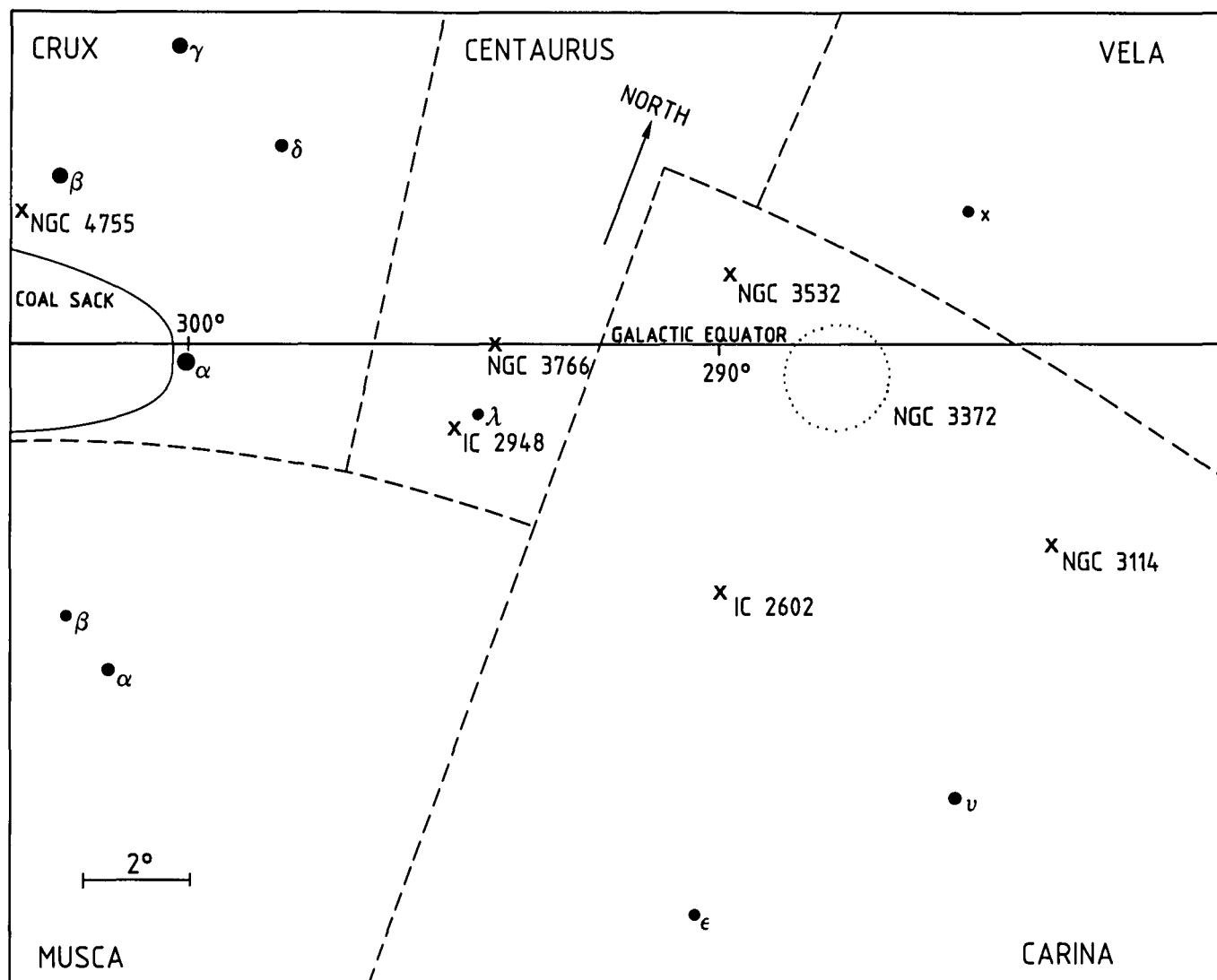

134 This photo of the Gum Nebula in H_α light was taken with a special wide-angle camera. The nebula is almost circular and has an angular diameter of no less than 36° . Parts of it can be seen on Plate 132, especially the dense area that is indicated on Fig. 17. Its distance is estimated at about 1300 light-years and its diameter is 800 light-years, so it is a really large object. Re-

cent observations show that the Gum Nebula is in fact a shell of interstellar matter expanding at a velocity of 20 km/s.

The origin of the Gum Nebula is a matter of some dispute. Several models have been suggested of which only the currently most plausible one will be mentioned here. According to this model, the Gum nebula is an old supernova rem-



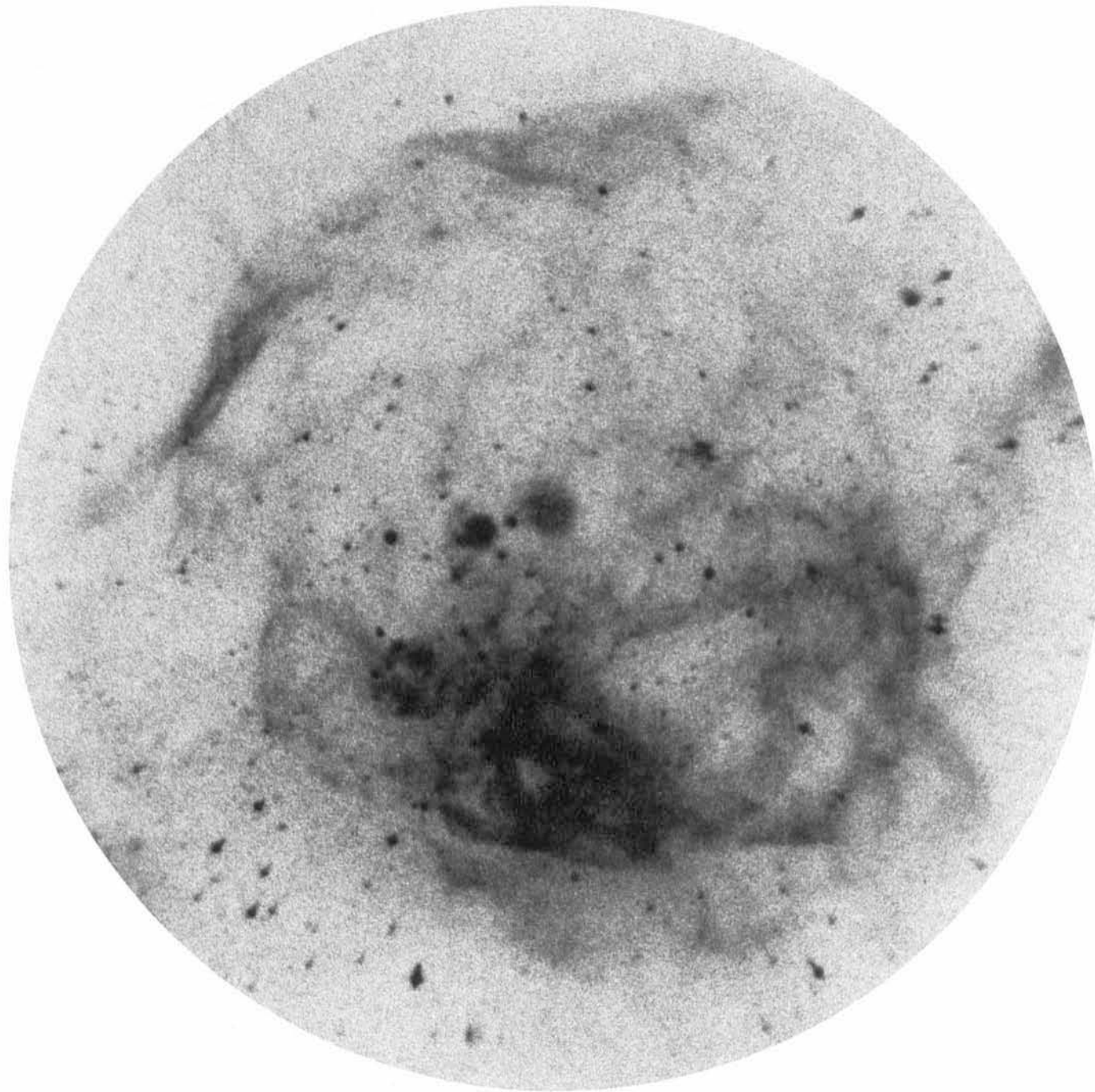

nant, in which a high temperature is maintained by a few hot stars. Based on observations, the age is estimated to be one million years or more. Normally such an old remnant would have cooled down to a very low temperature and so have become invisible, but inside this remnant there is an association of O and B stars. Its brightest member is γ Velorum, the multiple star mentioned before (Plate 132), of which two components emit strong ultraviolet radiation. Even brighter, especially in the ultraviolet, is the star ζ Puppis, a single star seen on Plate 124. It also lies deep inside the Gum Nebula, but it is outside the OB association. It is an interesting fact, however, that this star also seems to originate in the association. ζ Puppis is a so-called *runaway* star. It is moving at a high speed directly away from the OB association, and by tracing its motion backward in time, we find that one million years ago it was located within the association. Runaway O stars are believed to come from double stars, one of which component has exploded as a supernova, while the other has transformed its orbital motion into linear motion away from its origin. We may further speculate that it was the former companion of ζ Puppis that underwent a supernova explosion one million years ago and formed the remnant that we now see as the Gum Nebula, but this cannot be proved. However, the two hot stars γ^2 Velorum and ζ Puppis are probably the sources of the radiation that today keeps the old supernova remnant shining.

135 The Gum Nebula contains almost 40 *cometary globules*, of which the more impressive ones are shown in this and the following Plates. It should be mentioned that most cometary globules are rather faint objects, and these ones have been made clearly visible by means of advanced photographic contrast enhancement.

The present group of cometary globules originates from a cloud that must have contained several cores. Five globules are seen in the group, with the largest one in the middle, two smaller ones to the right, a medium-sized one containing a diffuse nebula to the lower left, and finally a very small globule down below. Behind them all stretches a large, slightly luminous tail.

The cometary globules are the dense cores of clouds, which, by the effect of ultraviolet radiation from nearby hot stars, are being excavated from more tenuous dark clouds. The ones seen here are more evolved than the Horsehead (Plate 130), but have not yet evolved into Bok globules (Plate 161). The original cores of the cloud have become the dense heads of the cometary globules, and in the shadow of these heads are the tails, in which some of the original cloud material still survives. Some parts of the tails also consist of material that has been eroded and swept away from the surface of the globules.

The hot stars mentioned above are massive O and B stars which burn their nuclear fuel at a prodigious rate and therefore seldom live longer than a few million years. If a cloud's core can survive until the disappearance of the destructive OB stars, it will remain as a long-lived, dark Bok globule.

Star formation is taking place in this region, because several young stars are found around the globules. The diffuse nebula in the middle of one of the globules is a Herbig-Haro object similar to the one seen on Plate 129, and this too tells us that a new star has very recently been formed. The star is still embedded in the globule, but it is detectable at infrared wavelengths.

The straight line passing down through the entire plate is the trail of an artificial satellite, which happened to cross the field during the exposure.

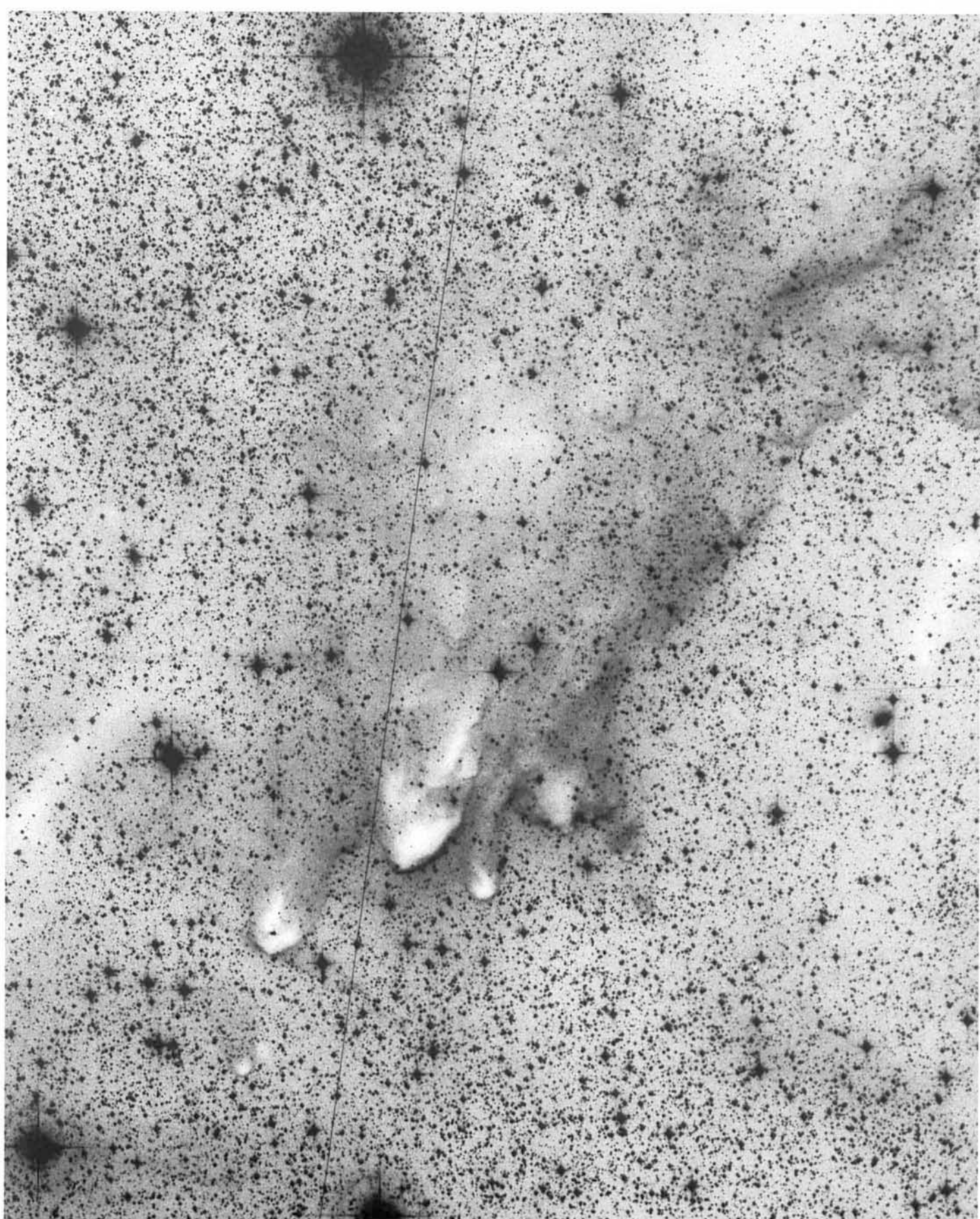

136 This is another cometary globule, also situated inside the Gum Nebula. Its tail points away from the centre of that nebula, where a number of luminous stars reside. Most cometary globules are faint, but they are not small. The dense, pointed head of the one seen here is about 2 arcminutes wide, and its tail is 25 arcminutes long. At the distance of the Gum Nebula, this corresponds to 1 light-year and 10 light-years, respectively.

Partly embedded in the head of the globule there is a young star, which is known as *Berney 135*. It is the brightest star just above the “nose” of the globule. This star was born in the globule, probably as a result of its violent history.

The elongated pattern in the tail behind the head of the globule is a reflection from a nearby bright star, which is outside the field of this photo.

137 This is another example of cometary globules in the Gum Nebula. The dominant one is unusual, because its highly structured head appears to be in the process of breaking up. The size of the head is 3 light-years, and the total length including the tail is 10 light-years. Behind the tail, there is a large diffuse cloud with at least two cores, which may eventually become new globules. Above the cloud is a smaller cometary globule, which apparently was excavated from the side of the diffuse cloud. No young stars have been detected in the two globules, but the cores in the large, diffuse cloud contain several young stars.

The reflected image at the upper right corner of the plate is an optical effect in the telescope. It originates from the third magnitude star σ Puppis.

138 The Vela supernova remnant appears in projection against the Gum Nebula in the sky. It has a diameter of 6° and is much smaller than the Gum Nebula, with which it probably has no direct physical connection. Its distance is uncertain, but it is believed to be somewhat farther away than the Gum Nebula. Half of the remnant is visible on this Schmidt plate. As may be seen, its eastern part is covered by some of the dark clouds in the area. The filamentary structure of the remnant is very prominent.

In order to trace its origins we have to go back some 12000 years. At that time, a red giant star experienced an energy crisis. For a long time it had been using its nuclear fuel profligately, and all of a sudden there was almost nothing left. The energy production in its interior decreased rapidly and the star could no longer support the heavy weight of its outer layers. The core of the star suddenly collapsed. The collapse released enormous amounts of gravitational energy and soon resulted in a gigantic explosion.

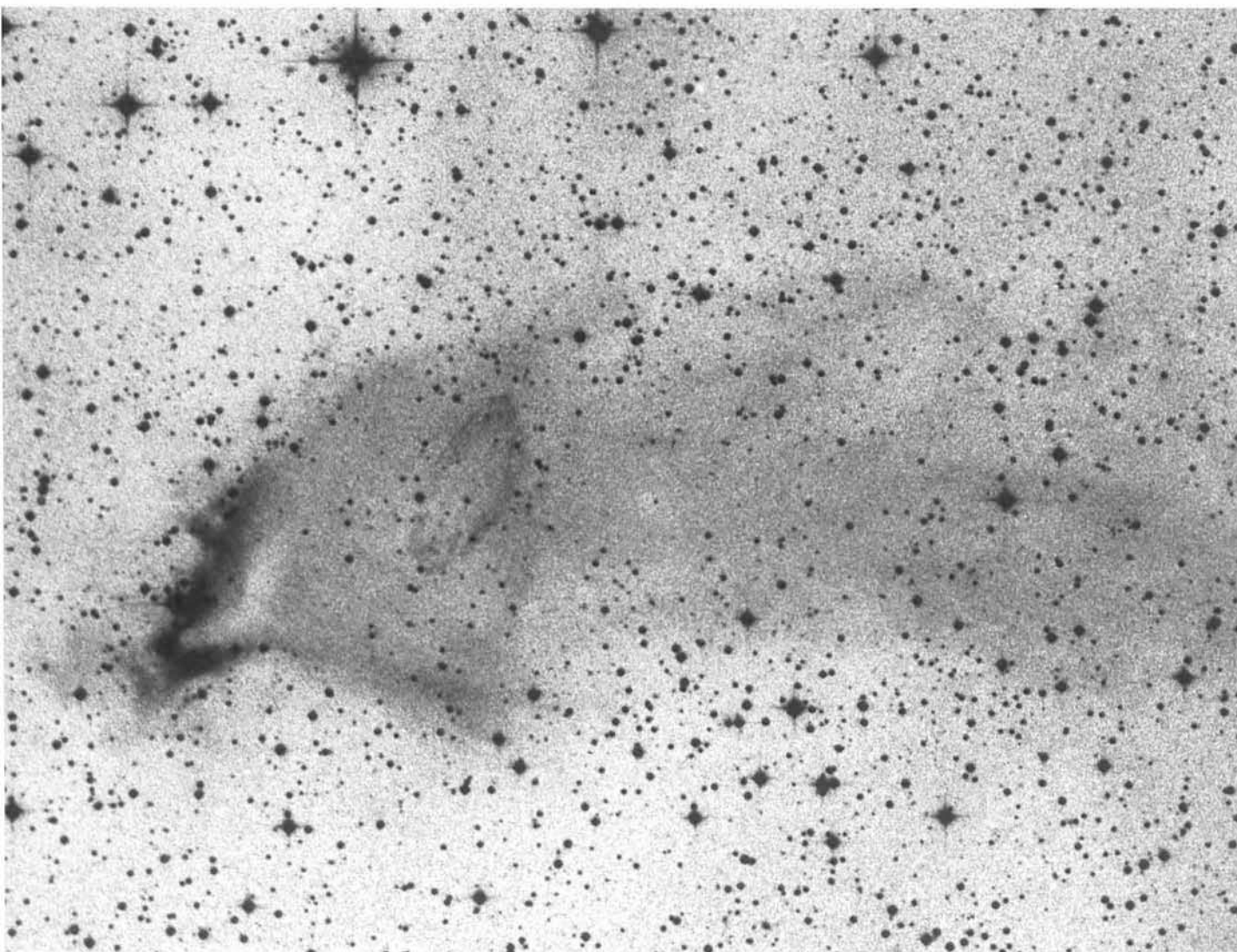



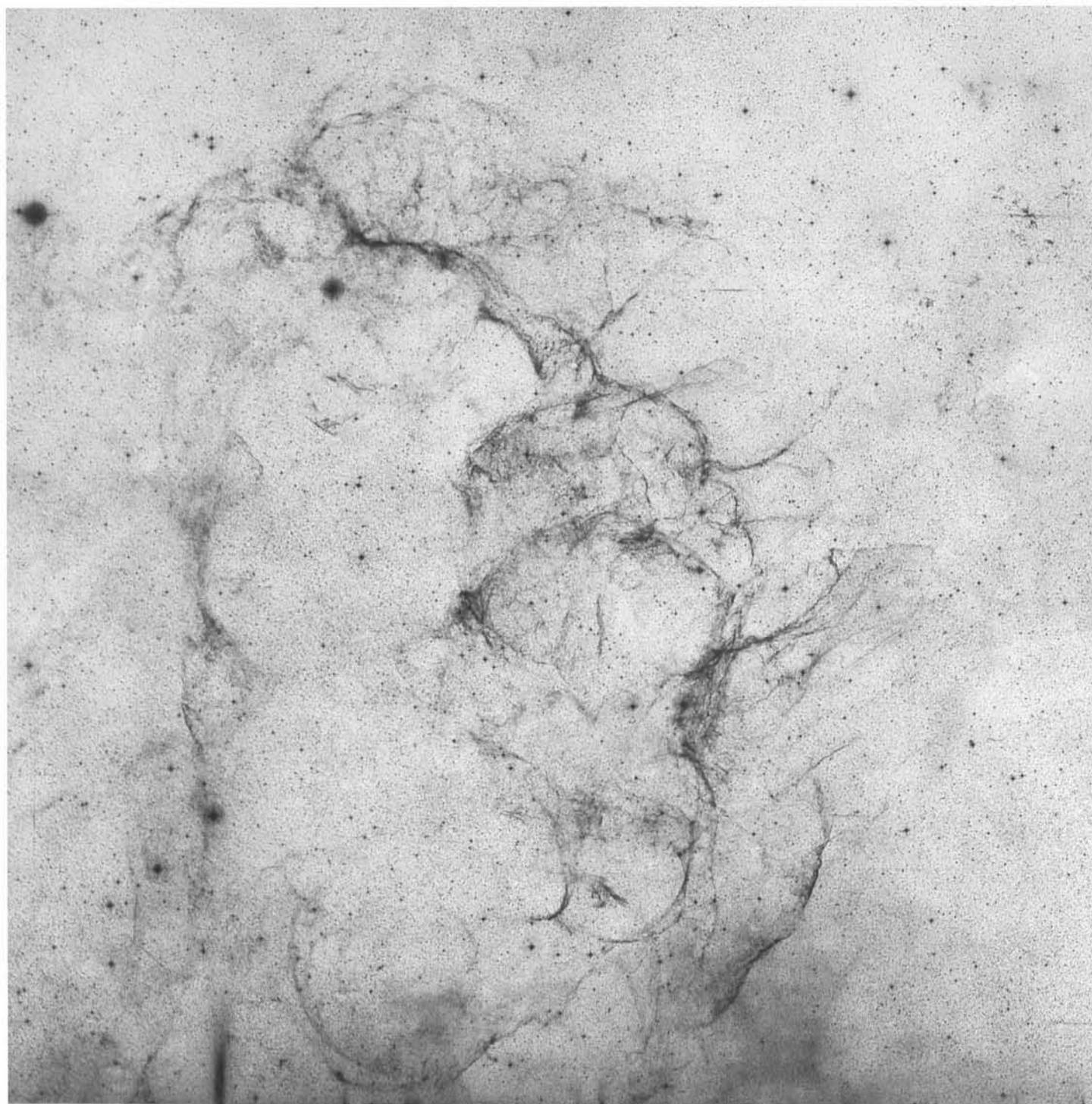

This was a *supernova explosion* during which, for a short while, the star radiated like a billion Suns, or as much as an entire, fair-sized galaxy. Most of the outer layers of the star were blown off during the explosion and ejected into space as a shell, expanding with a speed of many thousand kilometres per second.

The shell collided dramatically with the surrounding interstellar gas. By the shock of this collision the gas was heated and ionized, and started shining by itself. Repeated collisions have slowed down the expansion of the shell, but still today, about 12000 years later, we observe how the Vela shell expands with such speed that the surrounding gas shines with the beautiful colours seen on the next plate.

139 The filamentary structure of a part of the Vela supernova remnant is here seen in colour. Two colours are prominent, *red* which is H_{α} emission from hydrogen, and *blue* which is an emission of ionized oxygen. The excitation of oxygen and thus the production of blue emission requires a lot of energy. This emission is therefore strongest on the front side of the expanding shell, where the gas collides with the surrounding interstellar material. The convex sides of the filamentary arcs are therefore blue, while the red colour dominates on their concave sides.

But now back to the star that exploded. Did it vanish completely in the explosion or are there still remains of this star near the centre of the Vela nebula? The remains are there, in the form of a neutron star which revealed itself at radio wavelengths as a so-called pulsar in 1968. One year earlier, the exciting discovery of the first pulsar had been made. Today over 300 radio pulsars are known, but only two of these, the famous Crab pulsar in Taurus, and the much fainter Vela pulsar, have been observed to emit optical pulses.

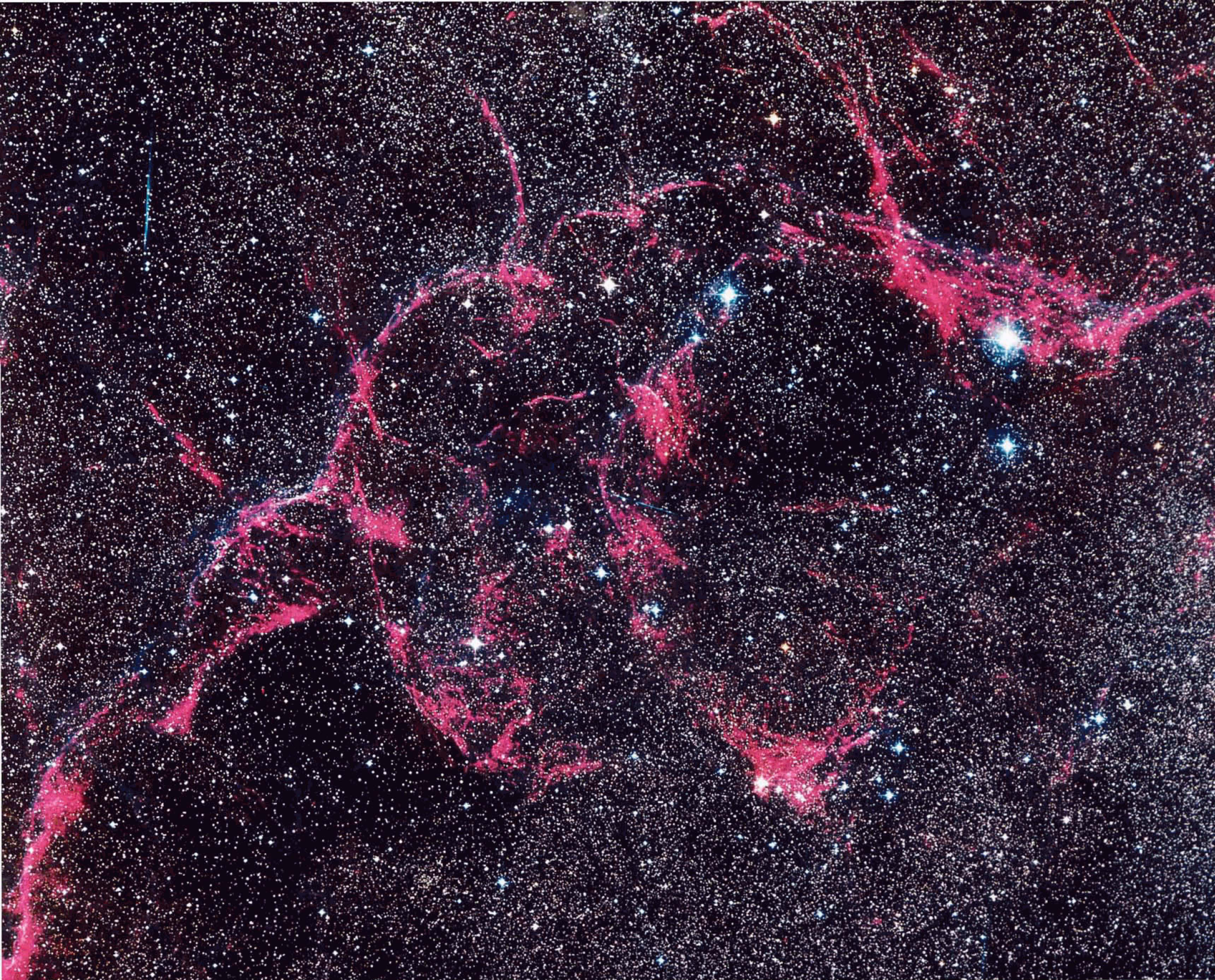

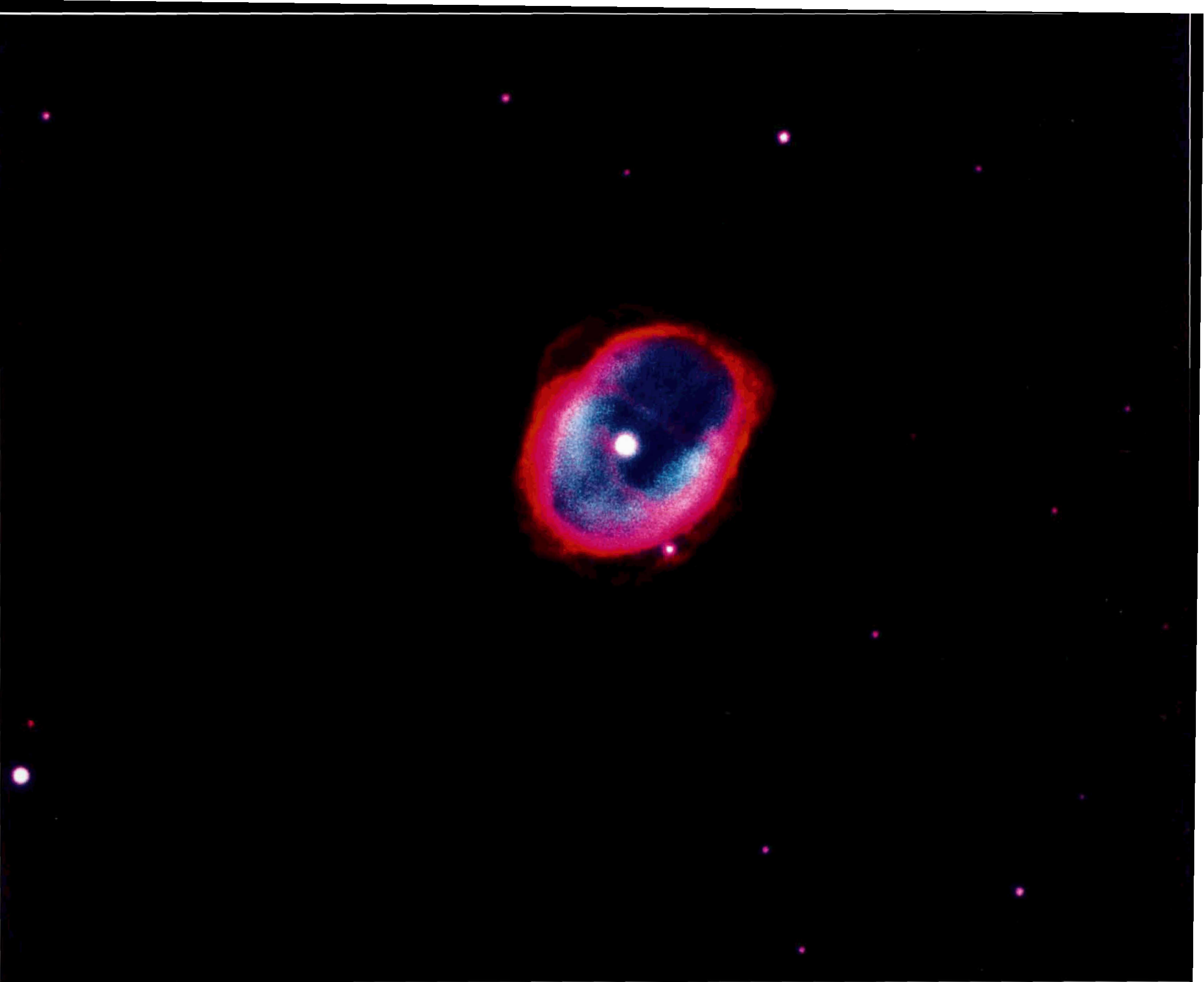

A pulsar emits short bursts of radiation in extremely regular sequence. The Vela pulsar is among the faster ones, with 11.20640115 bursts or pulses per second. The pulsars are neutron stars, which are incredibly compact and very small. Their diameters are 10–15 km, but they still weigh as much as the Sun. A pinhead sized sample of neutron-star matter, therefore, has the mass of a fully loaded oil tanker! They rotate furiously; they are like lighthouses, emitting a beam of radiation that sweeps over the surroundings. The neutron star in Vela makes a little more than eleven revolutions per second, corresponding to the pulse rate just mentioned.

There is little doubt that the neutron star of the Vela pulsar is the central body remaining after the Vela supernova explosion 12000 years ago.

Likewise, the neutron star of the Crab pulsar was created during the Taurus supernova explosion, which was observed in the year 1054. This extraordinary event was recorded by both Chinese and Japanese observers. Its gaseous remnant is the famous Crab Nebula, M 1, in Taurus.

The neutron stars slowly lose energy and become weaker. With age, the rotation becomes slower and slower. The relatively young Crab pulsar has a pulse rate of 30.1201319 per second, about 3 times as fast as that of the older Vela pulsar. Most pulsars observed are much less energetic, and rotate much more slowly – the slowest known pulsar makes only one revolution every 4 seconds. Accordingly, they are much older than the Crab and Vela pulsars. This agrees with the fact that the gaseous remnants from those supernova events cannot be detected at all; they have completely dispersed into interstellar space in the meantime. Note that in this Plate North is to the left.

140 Another interesting object in Vela is NGC 3132, a pretty planetary nebula. Planetary nebulae are small gaseous structures surrounding a central star. More than 1500 such objects are known. Most of them have regular shapes, like spheres or shells, which appear like rings when projected onto the sky. The term “planetary nebula” or “planetary” for short, was given to these nebulae long ago, because when viewed through a moderate-sized telescope, they look like planetary disks.

The central star of a planetary nebula is usually faint, but it is always very hot. It is typically a star of a few solar masses in an advanced evolutionary stage, which has nearly depleted its energy sources. Before it becomes a white dwarf star, it throws away some of its mass. The star’s outer layers are blown off and form a small nebula which expands with a velocity of 20–30 km/s. Eventually this matter disperses into interstellar space.

The matter in the nebula, mostly hydrogen, is heated by the short-wave radiation from the central star. It is hottest near the star, where the radiation is strongest. Here, the oxygen atoms are ionized and shine with a beautiful blue colour. Further out, the radiation is weaker, and consequently the gas is less hot. Here, the red H_α line becomes the dominant one.

141 The bright star that is seen near the centre of NGC 3132 posed a problem for many years. It is an A-type star and is not sufficiently hot to deliver the energy that is necessary to cause the observed ionization of the atoms in the nebula. But where does the energy then come from? This question was answered in 1976, when the ESO 3.6-m telescope was tested, soon after installation. As shown in this series of short exposures, the A-star has a faint companion. The angular distance between the two stars is only 1.6 arcsecond. A detailed analysis showed that the companion star is very hot, around 100000 K, and very luminous in the ultraviolet spectral region. It is very small; its radius is only 4% of that of the Sun. It is located near the geometrical centre of the nebula and there is no doubt that this faint, hot star is the energy source that keeps the NGC 3132 planetary nebula shining.

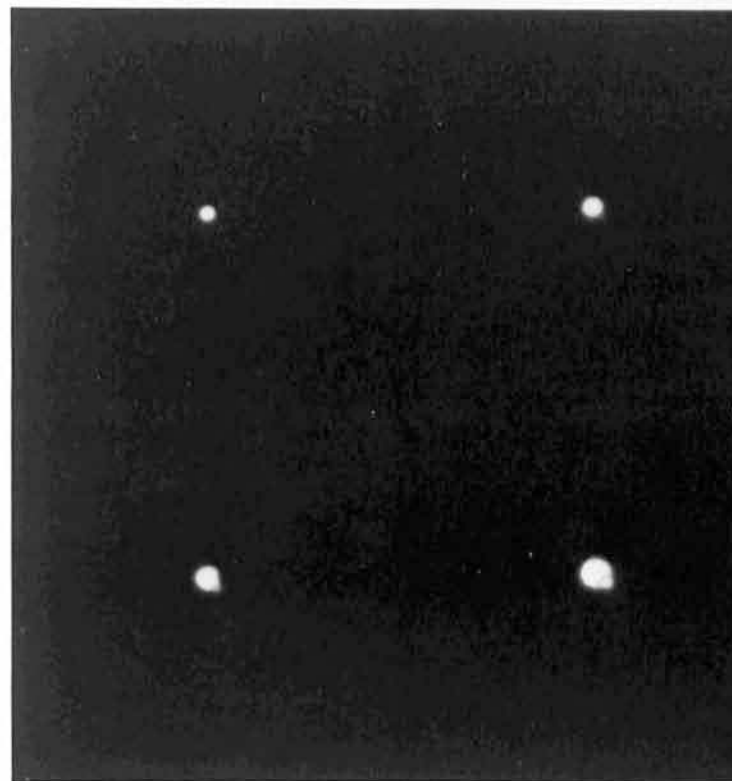



142 The *η Carinae Nebula*, NGC 3372, is a giant H II region. It lies in the Carina spiral arm at a distance of 8000 light-years. Inside the nebula we find the Carina OB1 association, with an estimated age of a few million years, and there are also a few young clusters. One of these clusters is NGC 3293 at the edge of the nebula, near the upper right corner of the photo.

The nebula has a diameter of 3°, or 400 light-years, and is much bigger than the Orion Nebula. Although it has been less studied, here too we have the impression of enormous amounts of luminous gas flowing from a central area. The centre of the nebula is near the tip of the overexposed V-shaped area, above the two broad lanes of absorption.

143 This photo of the central part of the *η Carinae Nebula* has been given a special treatment, which was recently developed at ESO in order to reveal the maximum detail. The nebula appears here as a very complex structure with several star clusters, with emission nebulae in the form of arcs, rims and filaments, and with a large number of dark clouds, of which several have the size and shape typical of globules.

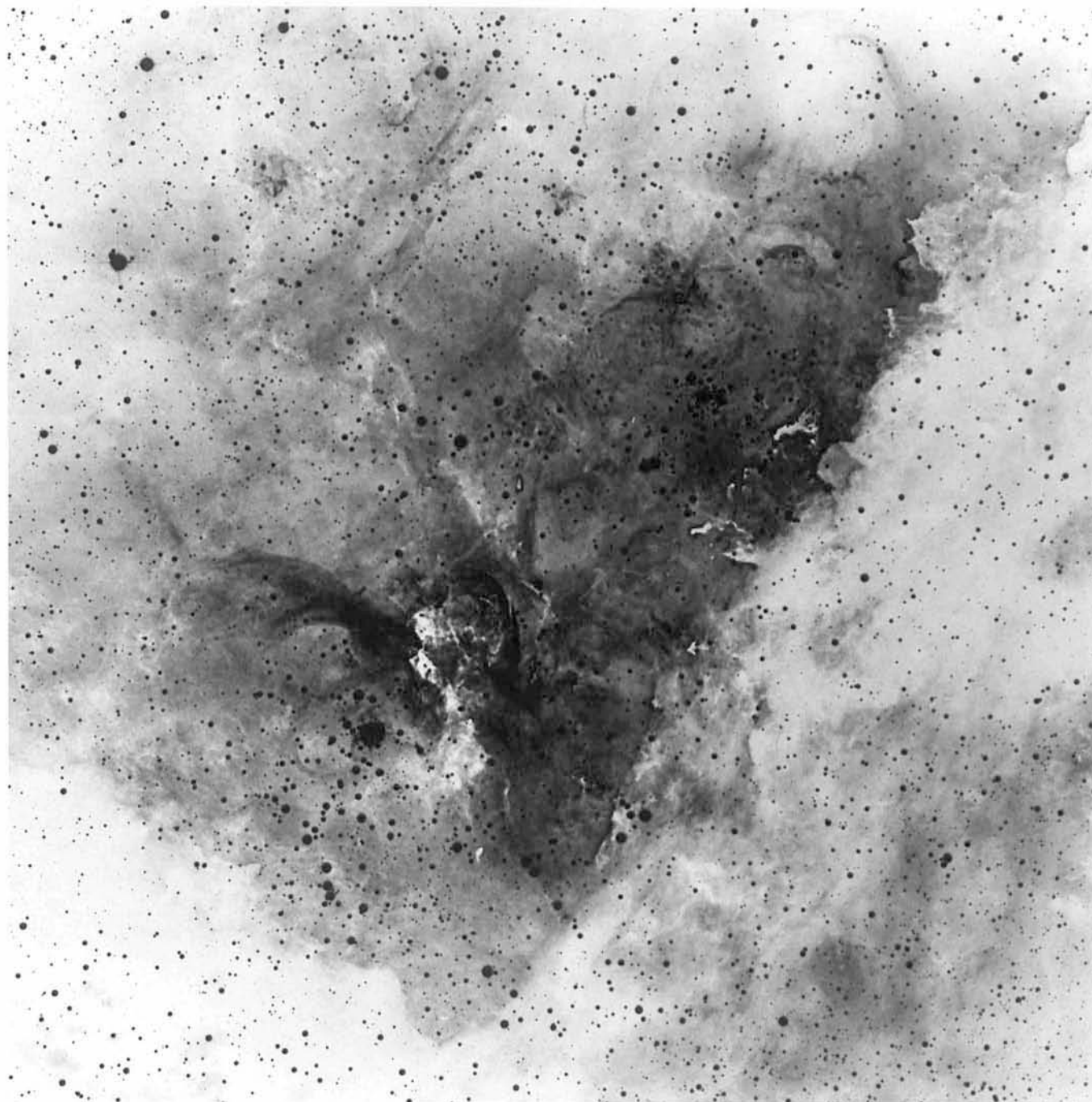

144 The heart of the η Carinae Nebula is the star η Carinae itself, seen here to the left of the centre. It is a peculiar star with a remarkable history. It was observed in 1677 by the English astronomer Edmond Halley (1656–1742) as a 4th-magnitude star. Later it was recorded as an irregular, variable star and towards 1840 its brightness increased considerably. It reached a maximum in 1843, and was then brighter than Canopus, α Carinae. η Carinae was at that time the second brightest star in the sky, surpassed only by Sirius. During the following decades it faded and it has been invisible to the naked eye for more than one hundred years. Now it is again slowly increasing in brightness.

Upon closer examination, however, it appears that it is not the star itself that has varied so dramatically. The star is now embedded in a small nebula, 0.4 light-years in diameter, which is so dense that it absorbs most of the light from the star in the visual region; only a small part is re-emitted. In the infrared spectral region the nebula is much more transparent, and η Carinae is in fact the strongest infrared source in the sky, apart from Solar System objects. Spectral measurements in the infrared show it to be a star with extreme characteristics. With a luminosity 5 million times that of the Sun, it is one of the most luminous stars in the Galaxy. Its total mass is over 100 Solar masses, but it loses gas at a rate of 0.07 Solar masses per year, much more than any other known star. The outflowing gas produces the surrounding nebula, which expands with a velocity as high as 700 km/s. The fast rate of mass-loss appears to have started when the star was at maximum luminosity. During the following decades, the outflowing gas condensed into so much dust that the obscuration soon caused a noticeable decrease of the star's apparent brightness. Such a high rate of mass-loss cannot, of course, continue very long, a few hundred years at the most. Coming generations of astronomers may anticipate further dramatic changes in η Carinae; it may possibly become the next supernova in our Galaxy.

This photo is a colour-composite made from wide-band filter exposures in blue and red, together with a narrow-band filter exposure in the green oxygen line. The colours are not entirely natural. The Keyhole Nebula at the centre is worth noting. Its upper part is a dark, circular area, partly covered by patches of luminous gas.

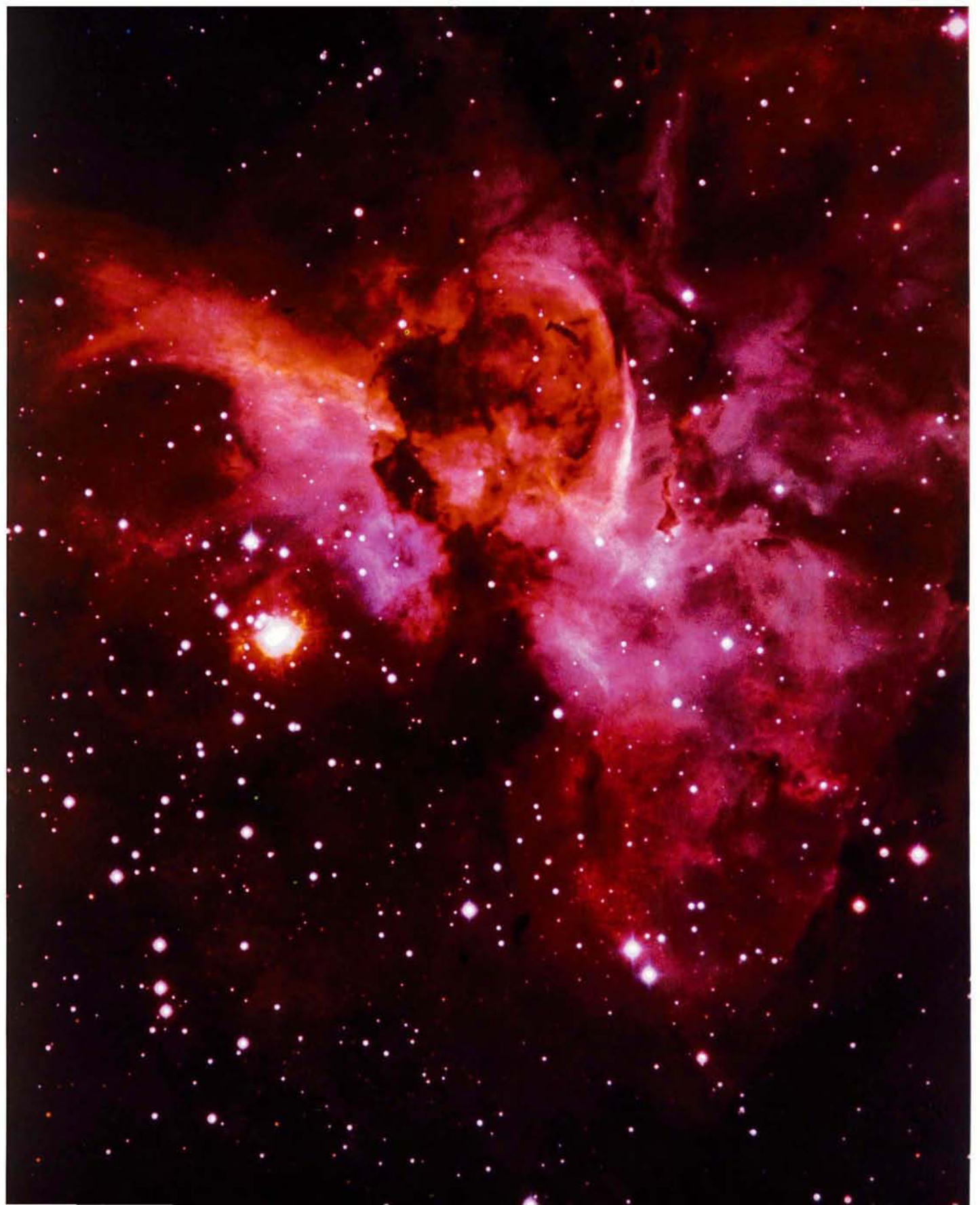

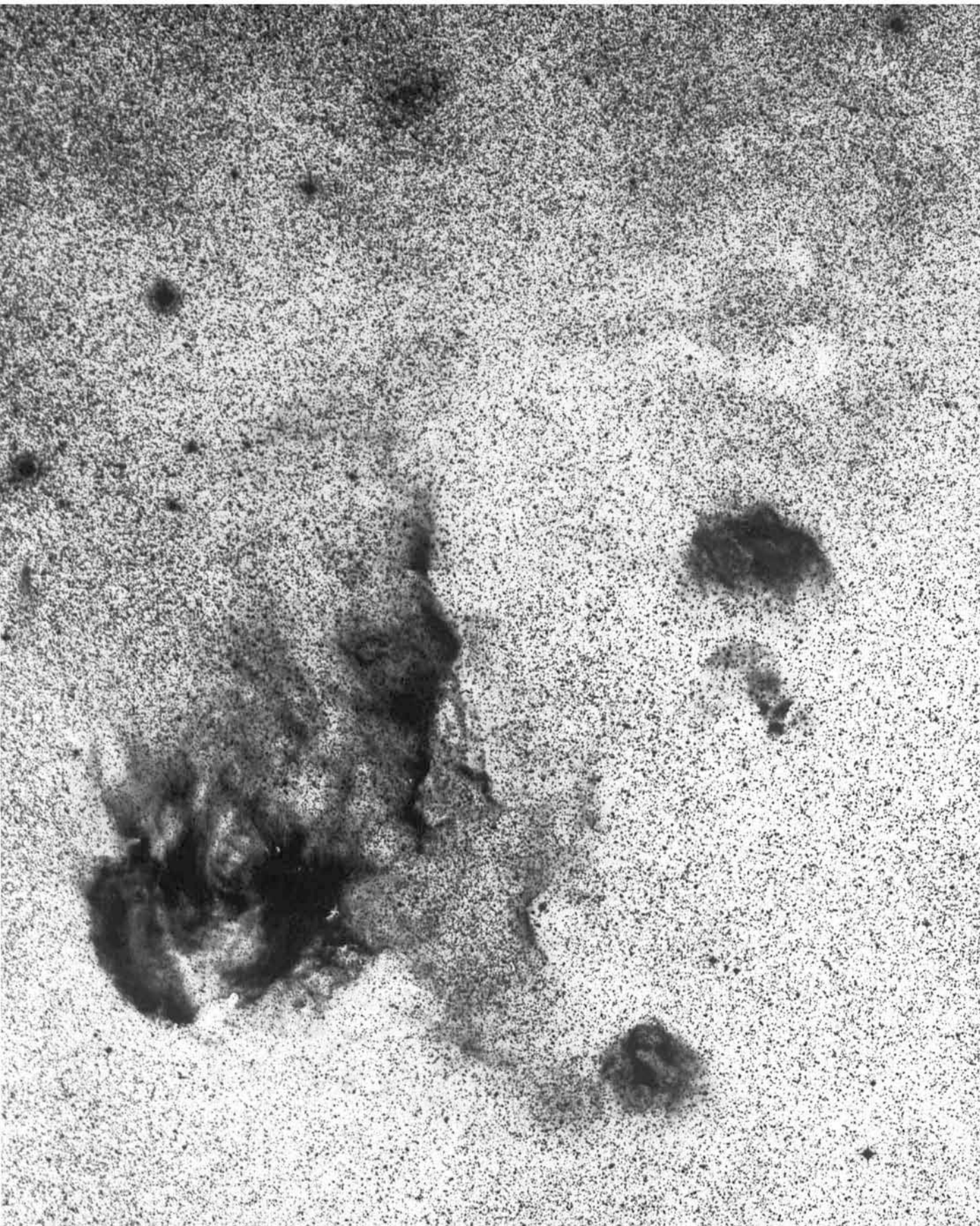

145 On our tour along the Milky Way, we encounter Centaurus twice, both before and after Crux. Most of the part of Centaurus that lies west of Crux is covered by this photo, which has been enhanced to reveal faint nebulosity. It is a composite of two plates; note the optical reflection of λ Centauri in the upper half.

We are here also looking at the Carina spiral arm, at a distance of 6000–8000 light-years. The emission nebula IC 2944 contains one of the richest groups of luminous O and B stars in the southern sky, known as the Centaurus OB 2 association. The massive stars were born inside a giant molecular cloud, and created an expanding bubble of hot gasses inside the cloud. Eventually,

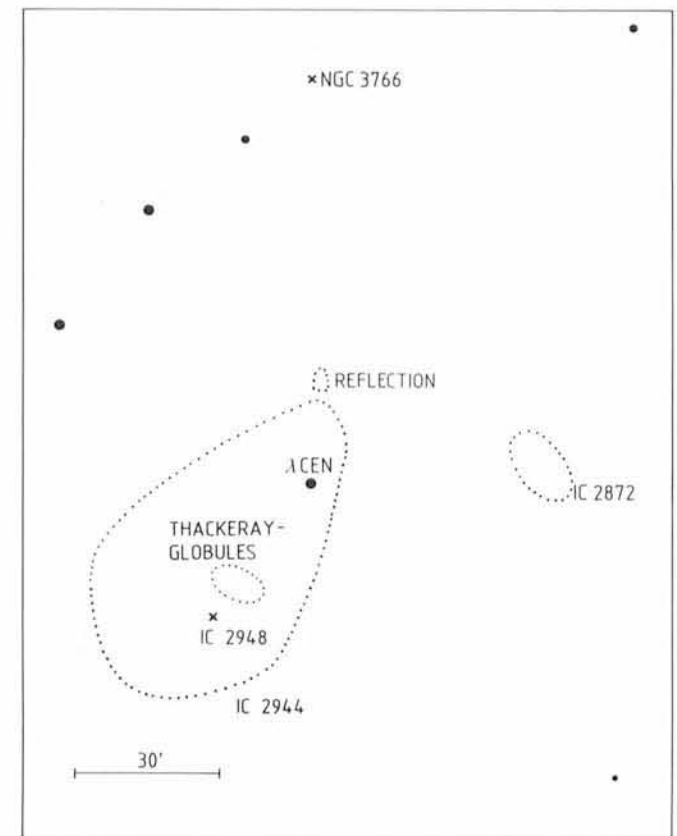

this bubble reached the surface of the cloud and burst wide open. We are at present looking down into the remaining cavity, and the rugged walls are clearly visible, particularly along the western edge of the nebula. The hot gasses are still slowly expanding and escaping from the cavity.

Towards the centre of IC 2944 a number of tiny dark objects are visible. They are known as “Thackeray’s globules”, after the South African astronomer A.D. Thackeray (1910–1977), who first discovered them in the early 1950’s.

146 This is a closer look at Thackeray’s globules in the nebula IC 2944. The immediate impression from the photograph is that the globules are breaking up and somehow being destroyed. Indeed, this is probably just what is happening. The hot and luminous OB stars, one of which is seen just beneath the biggest globule, emit intense ultraviolet radiation. When this radiation hits the globules, it creates an “ionization shock-front”, an area in which hot gas is in rapid motion. The front slowly eats its way into the globules, evaporating their surface layers. This can be seen as a bright rim around the biggest globule. Inhomogeneities in the globules and instabilities in the shock fronts create the jagged appearance of the globules, and all over their surfaces small pieces and clumps break off. Eventually all the globules will be destroyed by evaporation and will disappear.



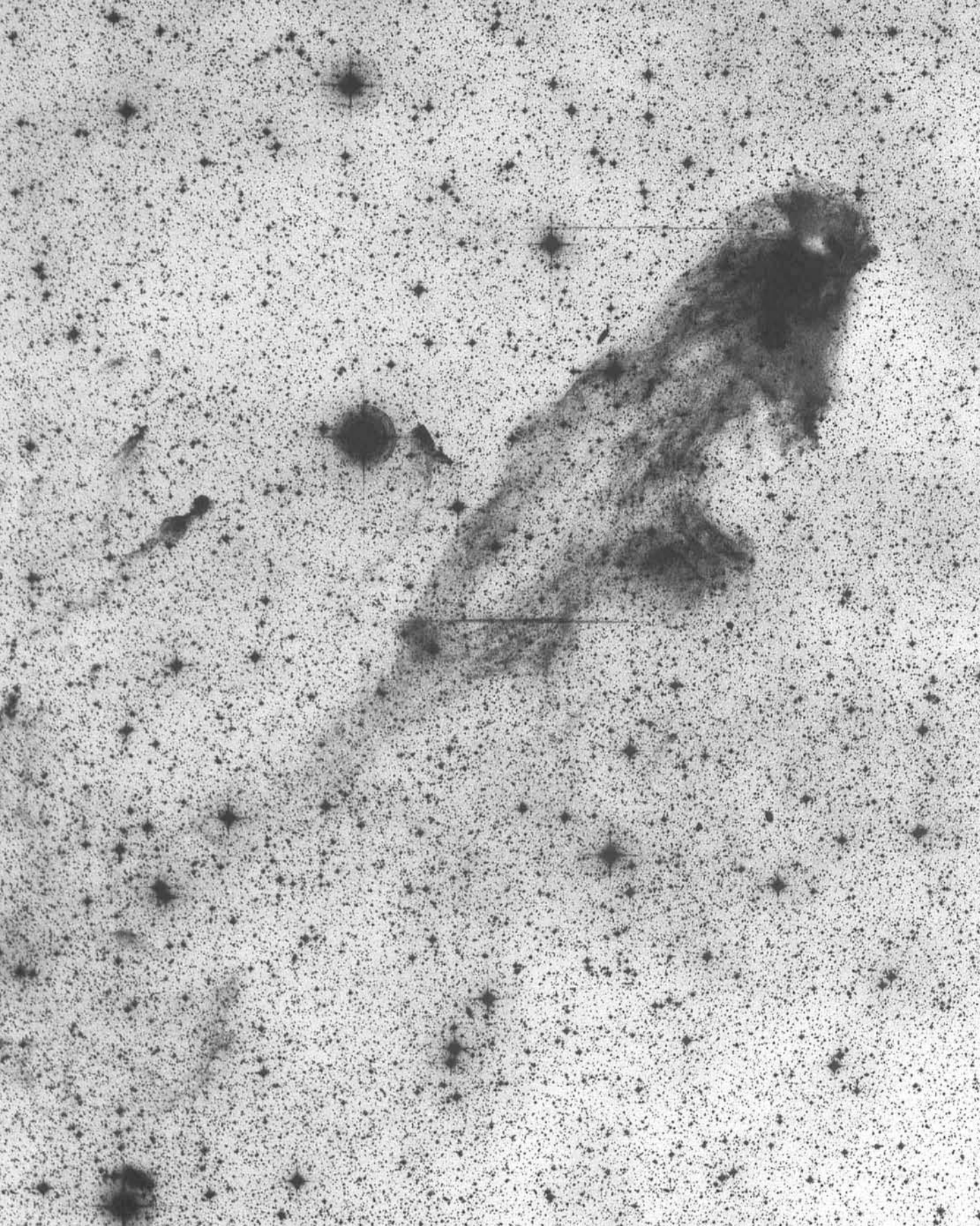

147 NGC 5367 is a cometary globule, with a dense head bordered by a bright rim, and with a long, luminous tail. Its apparent size is fairly large; from the tip of the head to the end of the tail it covers more than one degree of the sky. Its actual size is less well known, because it has proved difficult to determine its distance. If it is between 1 500 and 3 000 light-years away, its size would be no less than 30 to 60 light-years.

Star formation usually occurs in the galactic plane, where most clouds of gas and dust are located. However, some clouds at higher galactic latitudes are known, and young stars have been found in some of these. NGC 5367 is such a case, situated 21 degrees above the galactic plane.

Four young stars are associated with the dense head; one of them is a binary star. The components of this binary are B-stars, that is, they are more massive than the young, low-mass stars that are usually associated with globules. Infrared observations of the dense head itself have revealed an infrared source, which is a young star still embedded in the globule.

Little is known of why this globule has developed its long tail and how star formation was initiated. Contrary to the cometary globules in the Gum Nebula, which all point towards very luminous O stars, there are no such stars near NGC 5367. A possibility is that a massive star, somewhere to the north-west, exploded as a supernova some time in the past. The blast wave moving out through space could have hit a small cloud, forming the long tail and, by compressing the cloud, it might have initiated the birth of new stars.

148 This negative print shows the nebulosity NGC 3576 and some other objects in Carina, south of the cluster NGC 3590, which is visible close to the upper edge. It is obviously an active area with many hot spots, dark clouds, globules and pretty nebulous arcs.



In astronomical research, the century-old technique of photography has for several purposes been overtaken by a variety of more powerful methods, which also permit observations over a wider spectral range. However, photography is still superior whenever large regions of the sky have to be searched in order to identify interesting areas that are worthy of subsequent, dedicated research efforts. This photo is a typical example. A previously little-known nebulosity, east of the famous η Carinae Nebula, here appears as a most exciting field in this photographically masked and enhanced print.

There are plenty of possibilities for interesting research in this area, but little has been done so far. Perhaps this new photo will persuade some scientists to have a closer look.

2.4 The Milky Way from Crux to Norma

149 The Milky Way in Crux and Centaurus is a narrow band that contains very few bright objects. One reason for this is that the nearest spiral arm in the area, the Carina-Sagittarius arm, is far away at a distance of 8000 light-years. Crux got its name from the cross that is formed by its four bright stars, α , β , γ , and δ Crucis. This is the celebrated *Southern Cross*, easy to spot in the sky and well known from poetry, but in reality somewhat less impressive than most travellers from the northern hemisphere anticipate. Next to it, the naked-eye observer sees the *Coal Sack*, a veritable “hole” in the Milky Way. It is an oval-shaped, dark cloud, 8° long and 5° wide, on the borders of Crux and Centaurus. At times it has also been called the Black Magellanic Cloud or Magellans’s Spot. Only a single, faint star is visible to the naked eye inside

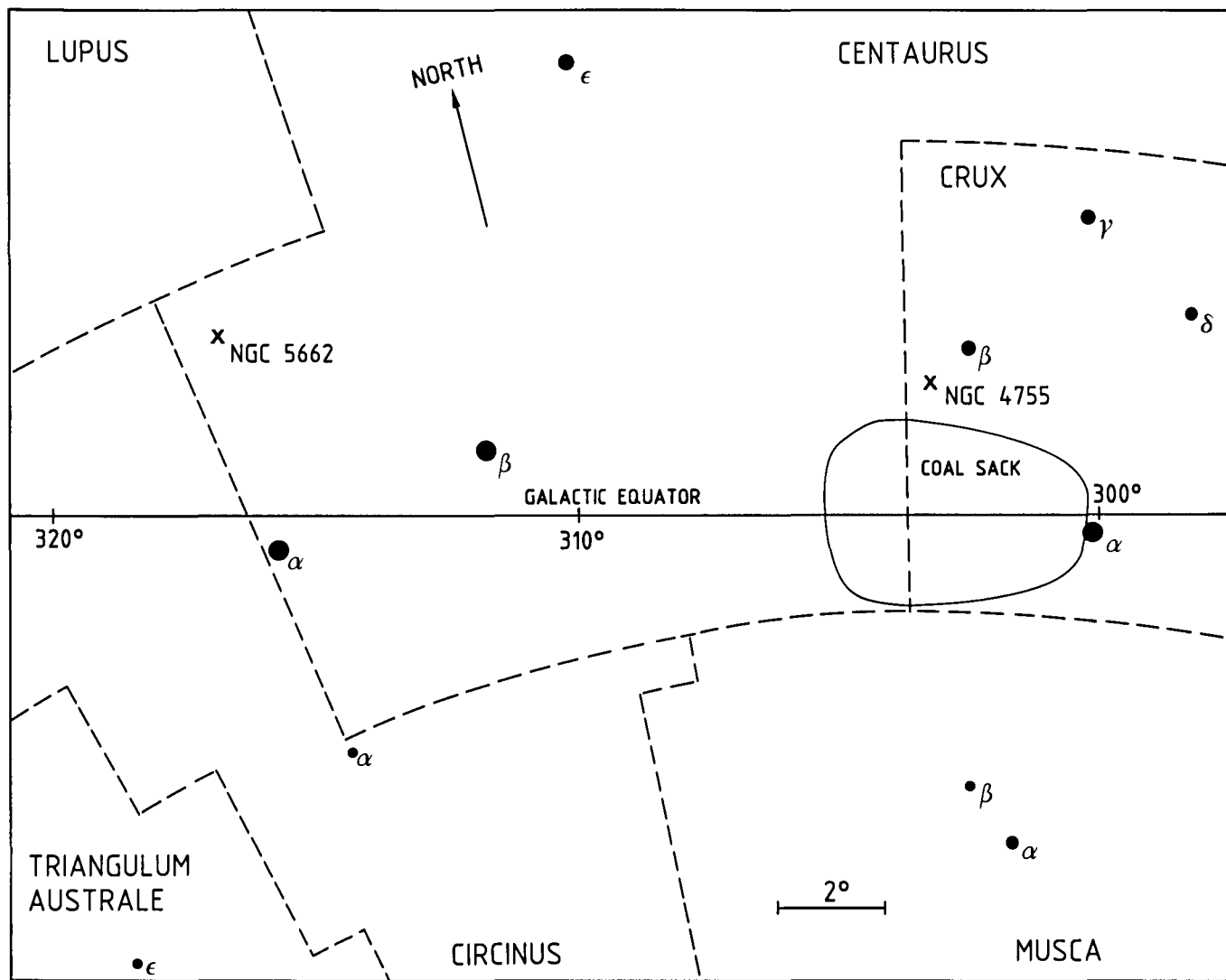

the Coal Sack. But this photo clearly shows that it is no hole; lots of stars are seen behind the cloud. The Coal Sack is quite inhomogeneous. There are areas where many stars are seen, and areas where only a few stars can be seen through the cloud. Analysis has shown that the absorption of light by the cloud varies from 50% in some areas to 90% in others. The distance to the Coal Sack is 550 light-years.

In Centaurus we find two very bright stars: α and β Centauri. In the list of the brightest stars they rank as number 3 and 10 respectively. α Centauri is a binary of low luminosity, only a little more than that of the Sun. It owes its apparent brightness to the fact that it is very close, only 4.3 light-years away. It is the second nearest star, while the nearest one (apart from the Sun, obviously!) is a remote, companion or-



biting α Centauri. It is a small dwarf star called Proxima Centauri, with a luminosity only 0.01% of that of the Sun.

The distance of Proxima Centauri is 4.2 light-years, while the Sun is only 8.3 light-minutes away. This difference clearly shows the emptiness of space even in the galactic disk. The British astronomer Sir John Herschel (1792–1871) illustrated the distance to α Centauri (Proxima Centauri was not yet known) with the following words:

“to drop a pea at the end of every mile of a voyage on a limitless ocean to the nearest fixed star, would require a fleet of 10000 ships of 600 tons burthen, each starting with full cargo of peas”.

An investigation of the population of stars in the solar neighbourhood has shown that, in the mean, there is only one star per 260 cubic light-years.

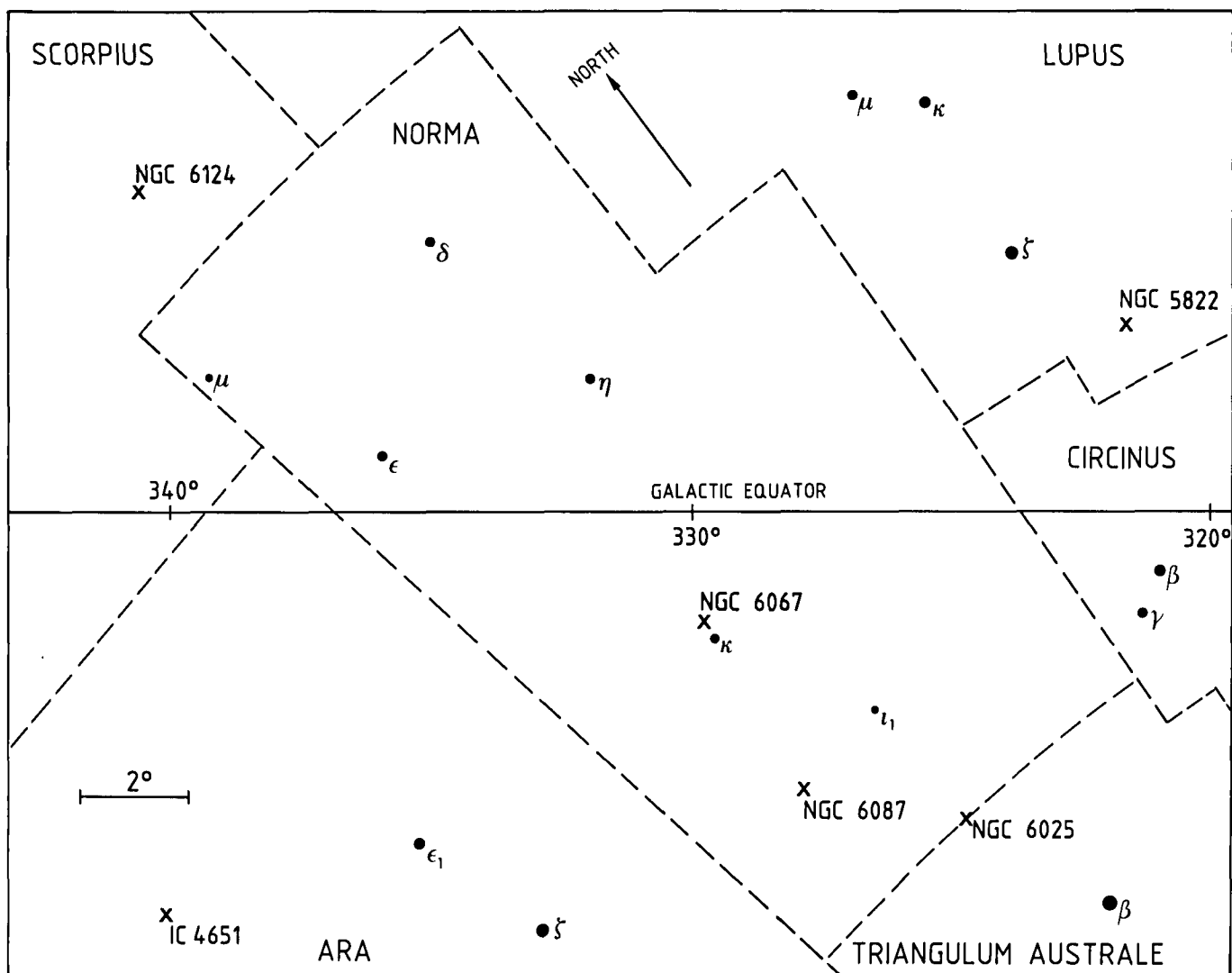

150 The Milky Way in and around Norma is rich in faint stars, while there are few bright ones. A lane of dark matter, stretching from α Centauri to Scorpius, crosses the field, but the absorption is moderate and many stars are seen through the dark clouds. Like the Coal Sack,

this lane is best seen in the panorama. The field holds a number of pretty galactic clusters, but only a few, faint, luminous nebulae. In Plate 156, we shall have a closer look at a little known nebula in Ara, NGC 6188, which is connected with the cluster NGC 6193.





151 Pardies drawing, South Pole. One of Pardies' beautiful stellar maps (cf. Plate 123) shows the constellations around the celestial South Pole. Notice the "Nubecula Major" and "Nubecula Minor" (the Magellanic Clouds).



152 Crux is the smallest of all the constellations, and it is known not only for the Southern Cross, but also for this beautiful stellar cluster, famous under the appropriate name of the *Jewel Box*. The designation is NGC 4755 and the brightest star is κ Crucis at 6th magnitude. The cluster is young and contains several blue supergiants, like κ Crucis itself, and also a number of more evolved red supergiants. When viewed through a small telescope, it is an impressive cluster of differently coloured stars, and it is also dimly visible to the naked eye.

153 The planetary nebula IC 4406 lies at the outskirts of the Milky Way in Lupus (the Wolf). It belongs to the class of bipolar nebulae. Its shape seems to be cylindrical with material flowing along the axis of the cylinder in both directions.



154 The planetary nebula Shapley 1 is a beautiful example of a regular shell nebula. The shell appears as a misty veil. Its mass is not very impressive, only about 0.1 solar mass.

155 A closer view of the Milky Way at the border of Norma and Ara reveals many patches of dark clouds and a few open clusters. There is an area with emission nebulosity around the cluster NGC 6193, and a strange object, NGC 6164-65, which looks like a reversed "S". NGC 6164-65 has some similarity with a planetary nebula. There is a star at its geometrical centre, but the nebula itself is unusual. From its appearance, it is difficult to decide whether it has the shape of a bar or of a torus. The central star is a triple system with a hot, blue star as its main component. Again it is not clear whether this star or one of its fainter companions ejected the material which formed the nebula.

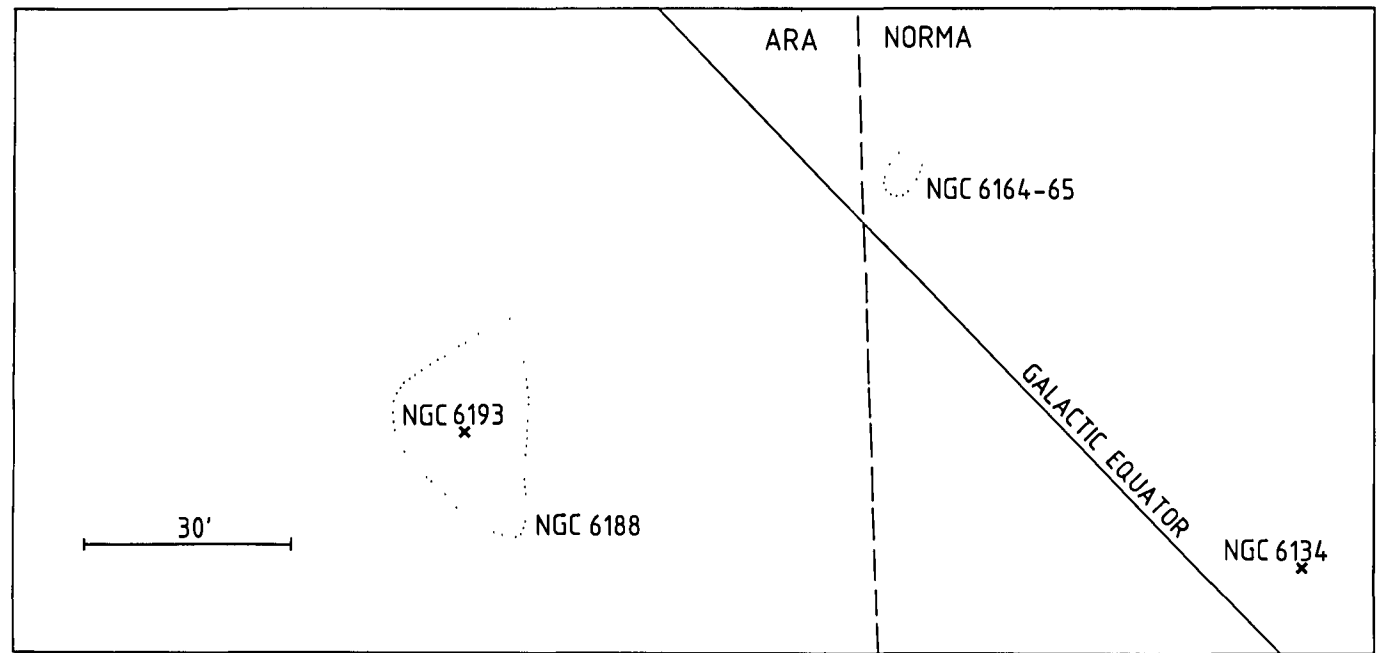

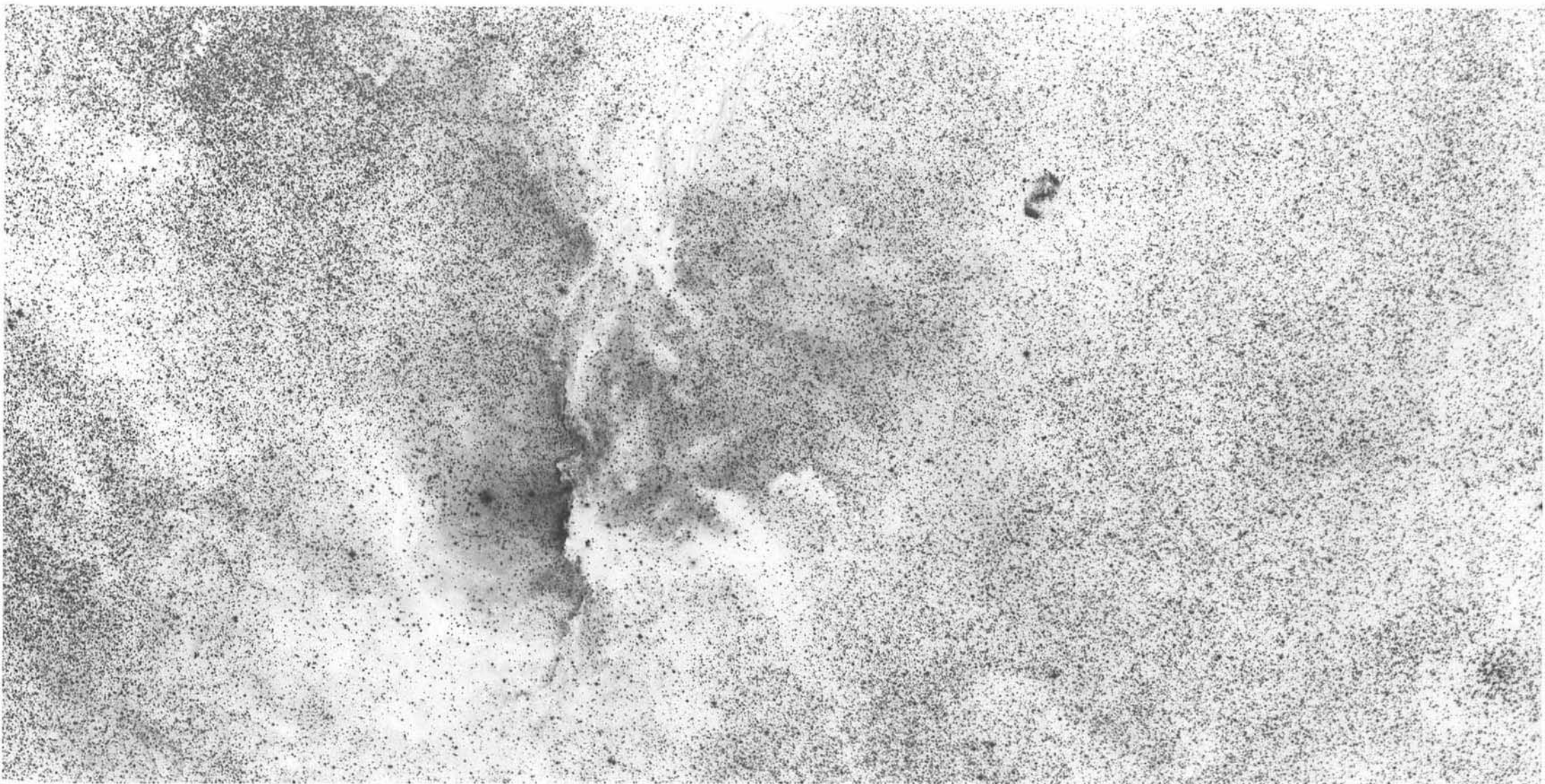

156 The open cluster NGC 6193 in Ara, with the bright star HR 6187, is at a distance of 4000–4500 light-years. It is a young cluster of bright O and B stars, the ultraviolet radiation from which keeps the emission nebula NGC 6188 glowing.

Remnants of the giant molecular cloud out of which the cluster formed are still visible as a long irregular front of dark material to the west of the cluster. On astronomical timescales this is a very short-lived region. The cluster stars were born a few million years ago, but they have already managed to destroy a large part of the original cloud. The bright and diffuse red rims of the molecular cloud's front facing the luminous stars are evidence of the continuing evaporation of the outer layers of the cloud. Such a region, with its violent interaction between a hot emission region and a cold dark cloud, is an ex-

cellent environment for star formation. A star near the plate centre is surrounded by a blue nebula. It is seen in front of the molecular clouds, and provides evidence that stars are being produced in these clouds. Furthermore, a small, red nebula with three faint stars in a line, seen a little further down in the very darkest part of the molecular clouds, has been found to be an active star-forming region. Infrared observations, which enable astronomers to look inside such a cloud, have revealed a small group of newborn stars, still embedded in the cloud from which they were formed.



2.5 The Milky Way from Scorpius to Scutum

157 Here the Milky Way in Scorpius, Ophiuchus and a part of Sagittarius is shown. As indicated in Fig. 23, the direction of the centre of our Galaxy is in Sagittarius, near the borders of the two other constellations. Scorpius is well populated with open clusters. Two open clusters, M 7 and M 6, are outstandingly bright. M 7 is the brightest and the nearest of the two. Their distances are 800 and 1600 light-years and they are both of medium age, of the order of one hundred million years. M 7 is the southernmost object in Messier's catalogue. Two bright globular clusters, NGC 6388 and M 62, are situated in Scorpius and Ophiuchus. The nebulae in this area are faint and very red. This is to some extent due to absorption of their light in the intervening clouds, which are clearly seen on this Plate.

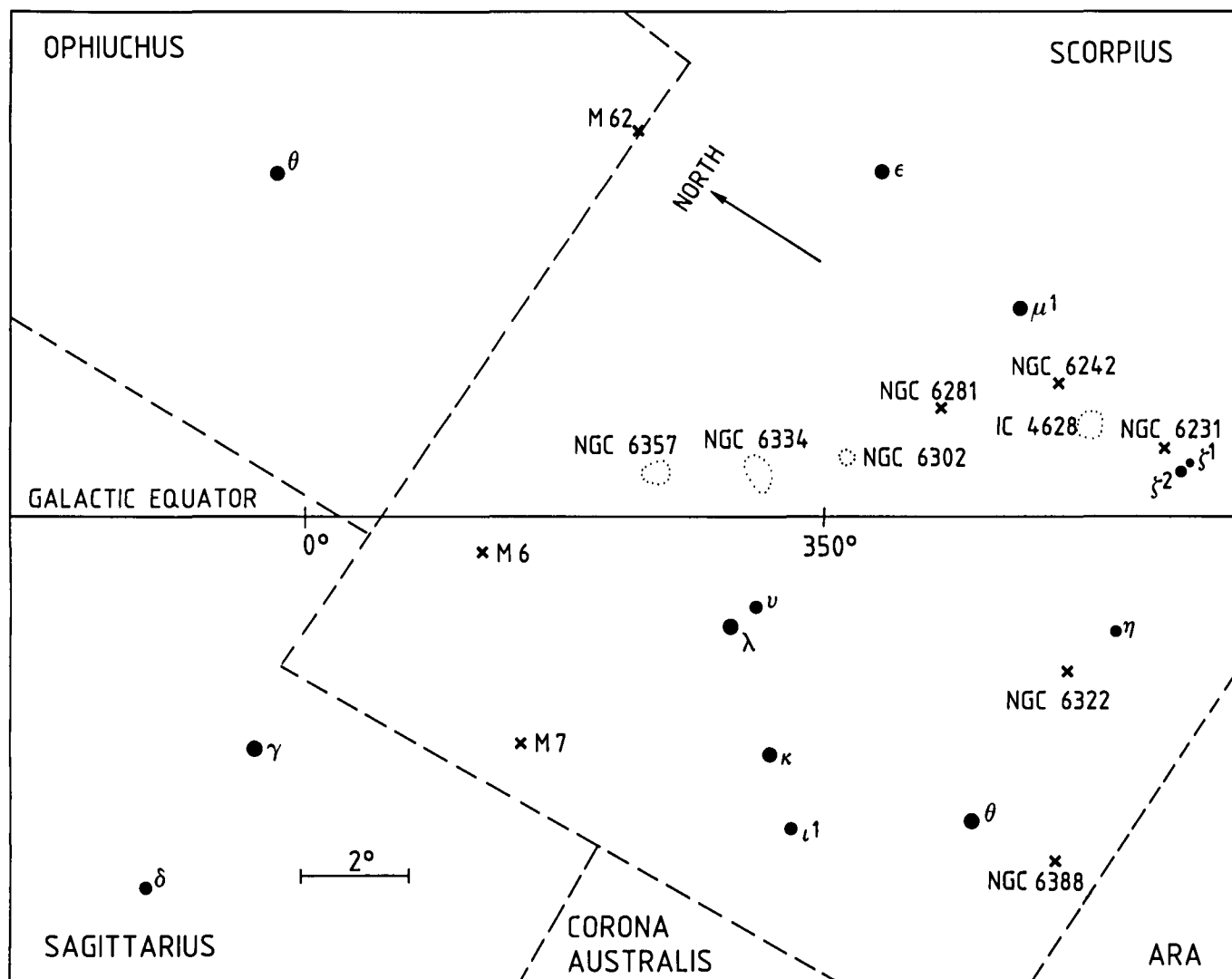



158 This area of the Milky Way in Sagittarius, Serpens Cauda (the Serpent's Head) and Scutum (the Shield), completes our tour along the southern Milky Way. The celestial equator crosses the galactic equator east of Scutum in Aquila, just outside this field.

It is a magnificent area, especially in Sagittarius, and it contains no less than 13 Messier objects. Here we find several famous emission nebulae, the Lagoon Nebula (M 8), the Trifid Nebula (M 20), the Omega Nebula (M 17) and the nebula M 16. There are also several open clusters, M 21, M 23, M 25, M 18, M 26 and M 11, and two globular clusters M 22 and M 28, which appear nearly starlike on the small scale of this photo. M 24 is not a cluster, but a cloud of stars, or rather a bright area of the Milky Way seen against the surrounding dark clouds.

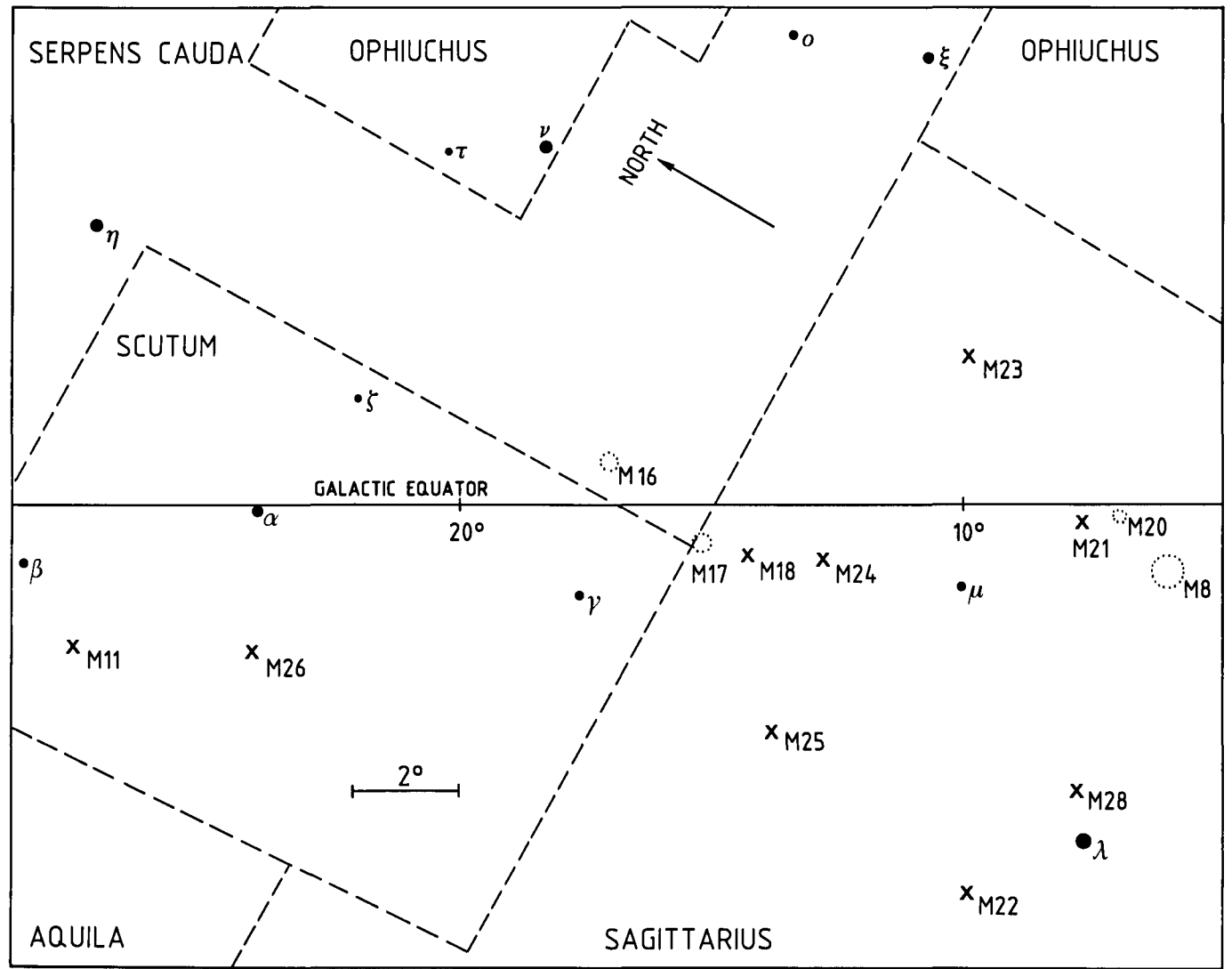



159 We start our tour at the right edge of Plate 157 and shall first take a closer look at the cluster NGC 6231 and its surroundings. It is a young cluster with many hot stars, and it forms the nucleus of the Scorpius OB1 association. This association, at a distance of 6500 light-years, contains 70 O-type stars in a volume about 200 light-years in diameter. The ages of the association and the cluster are similar and have been determined as 5 million years. The region must have been a very effective birthplace for massive stars. Among the many luminous stars, the most magnificent one is ζ^1 Scorpii. This star is very luminous, it may radiate as much energy as one million Suns. Its close neighbour, as seen from Earth, ζ^2 Scorpii, is much less luminous, although it looks brighter. This is because ζ^2 is a nearby star, only 100 light-years away, while ζ^1 is at a distance of 6500 light-years.

Today the area of the Scorpius OB1 association is no longer a fertile area for star formation. Ultraviolet radiation and stellar winds have blown away most of the material and have made a large cavity. The cavity is enclosed by a shell of gas that is ionized and shines in H_α light, as seen on this photo exposed in red light.

The shell, of which the southern part is clearly seen, might be interpreted as the remnant of a supernova explosion, although its appearance makes this explanation less likely. Moreover, we now know that strong stellar winds from hot stars are able to produce low-density cavities in the interstellar medium.

The nebula north-east of NGC 6231 is IC 4628. It seems to be swept by strong winds which blow more or less at right-angles to the direction of NGC 6231. IC 4628 is somewhat closer, at a distance of 5300 light-years, and it probably has no immediate connection with NGC 6231.

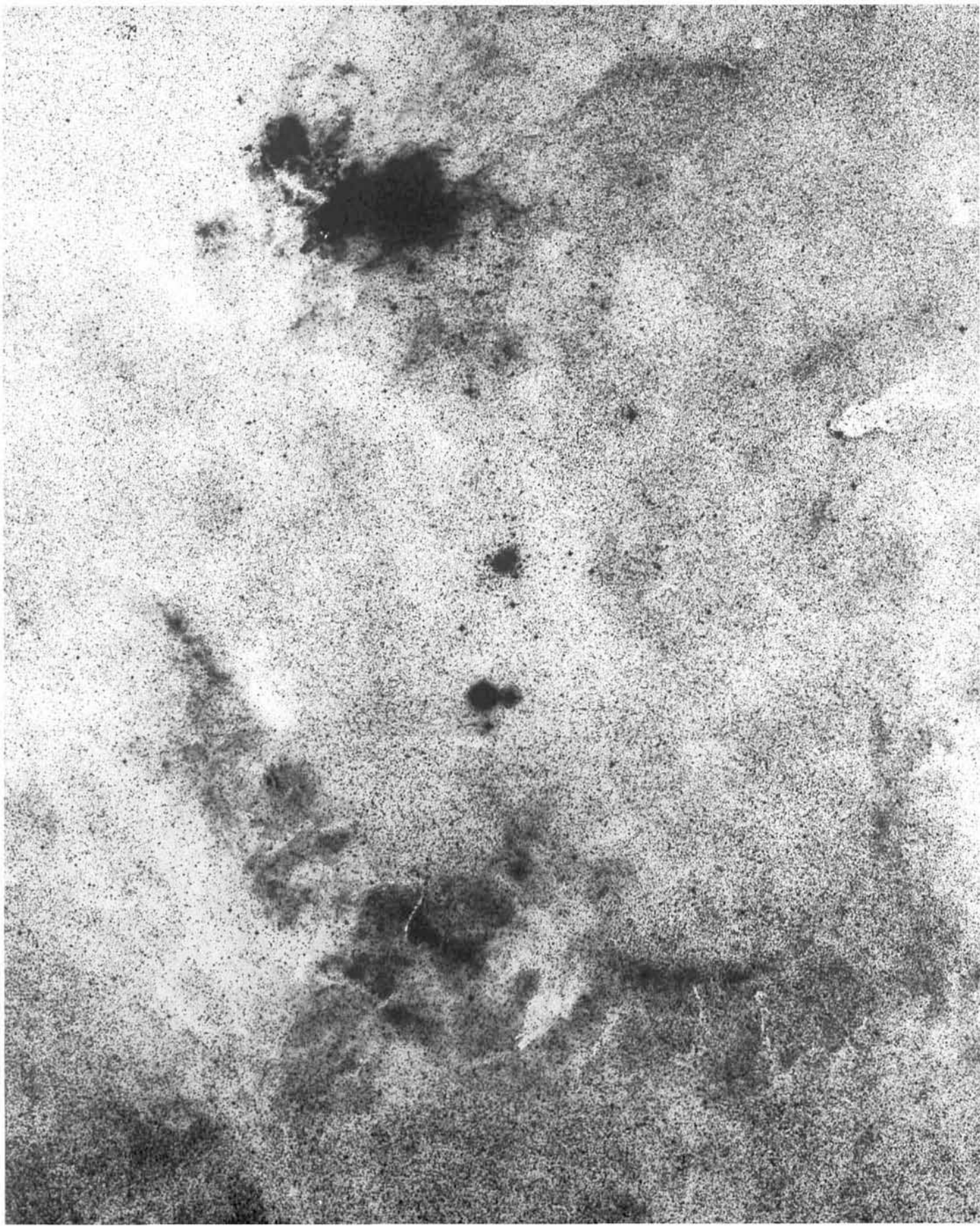

The unusual, elongated object seen on the right belongs to a category that is known among astronomers as “elephants’ trunks”. Such structures are often found at the edges of H II regions, and they have received this peculiar name, because of the striking resemblance. They are formed when newborn massive stars appear in a dark molecular cloud and start to push the surrounding material away, creating an expanding bubble of hot gas. The walls of such a bubble are unstable, and while most of the walls continue to recede from the luminous young stars, dense tongues of material are sometimes left behind. These objects therefore always point towards one or more massive O and B stars. In the particular case seen here, the elephant’s trunk points toward NGC 6231. Because of the compression of the material, new stars can be born here. The nebulous stars seen in the front of and along the elephant’s trunk have just been formed. Spectroscopic observations have shown that these young stars are more massive than our Sun, but much less massive than the luminous stars in NGC 6231.

160 IC 4628 has an interesting morphology. The nebula is split into two separate parts, which are connected by a bridge of strongly absorbing matter. It is also dotted with patches of dark and of luminous matter. The stars in the cluster just below the nebula are responsible for the ionization of the gas, possibly together with some other stars imbedded in the nebula. Other open clusters in the area are NGC 6242 at the top of the Plate, and NGC 6268 near its north-eastern corner.

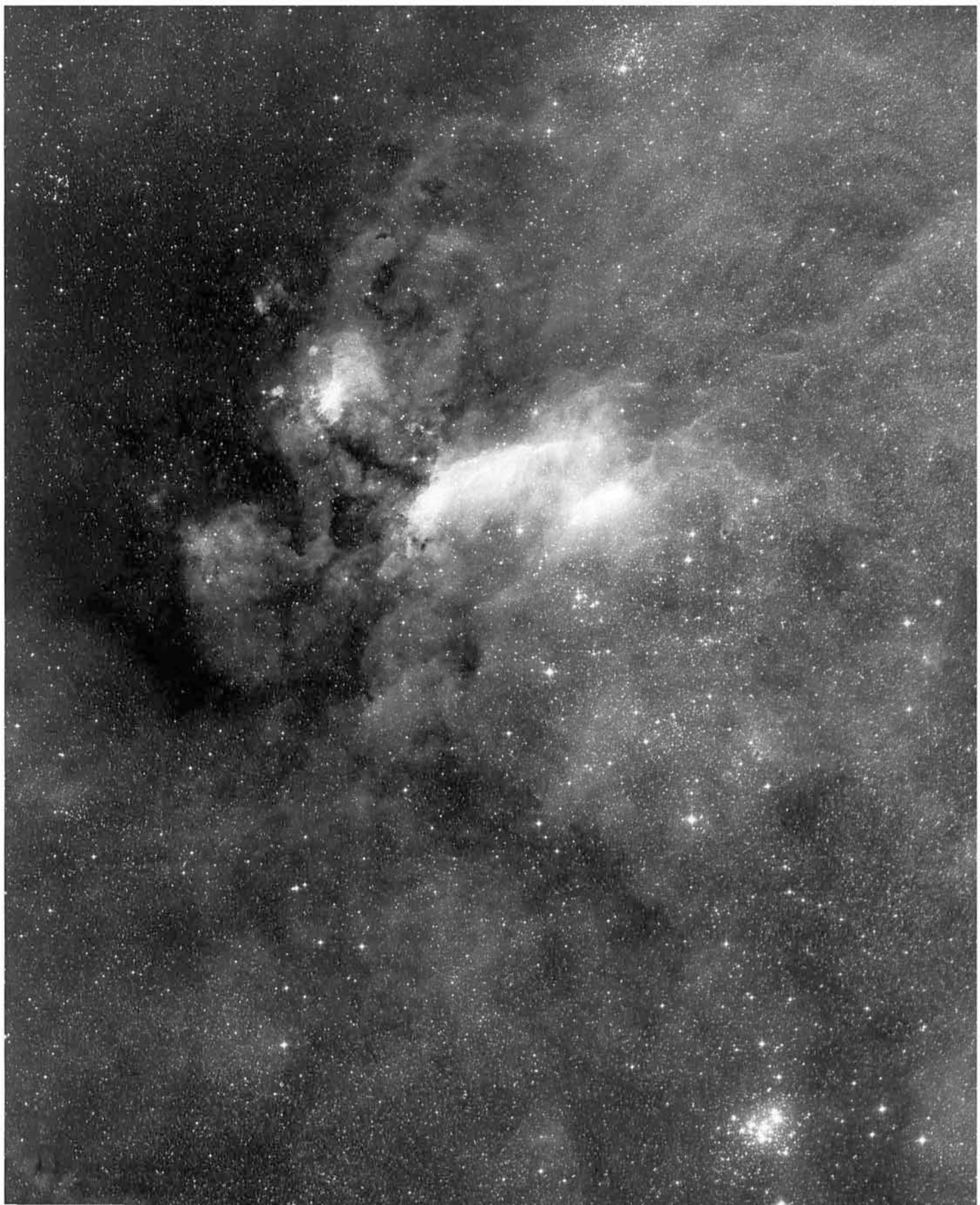

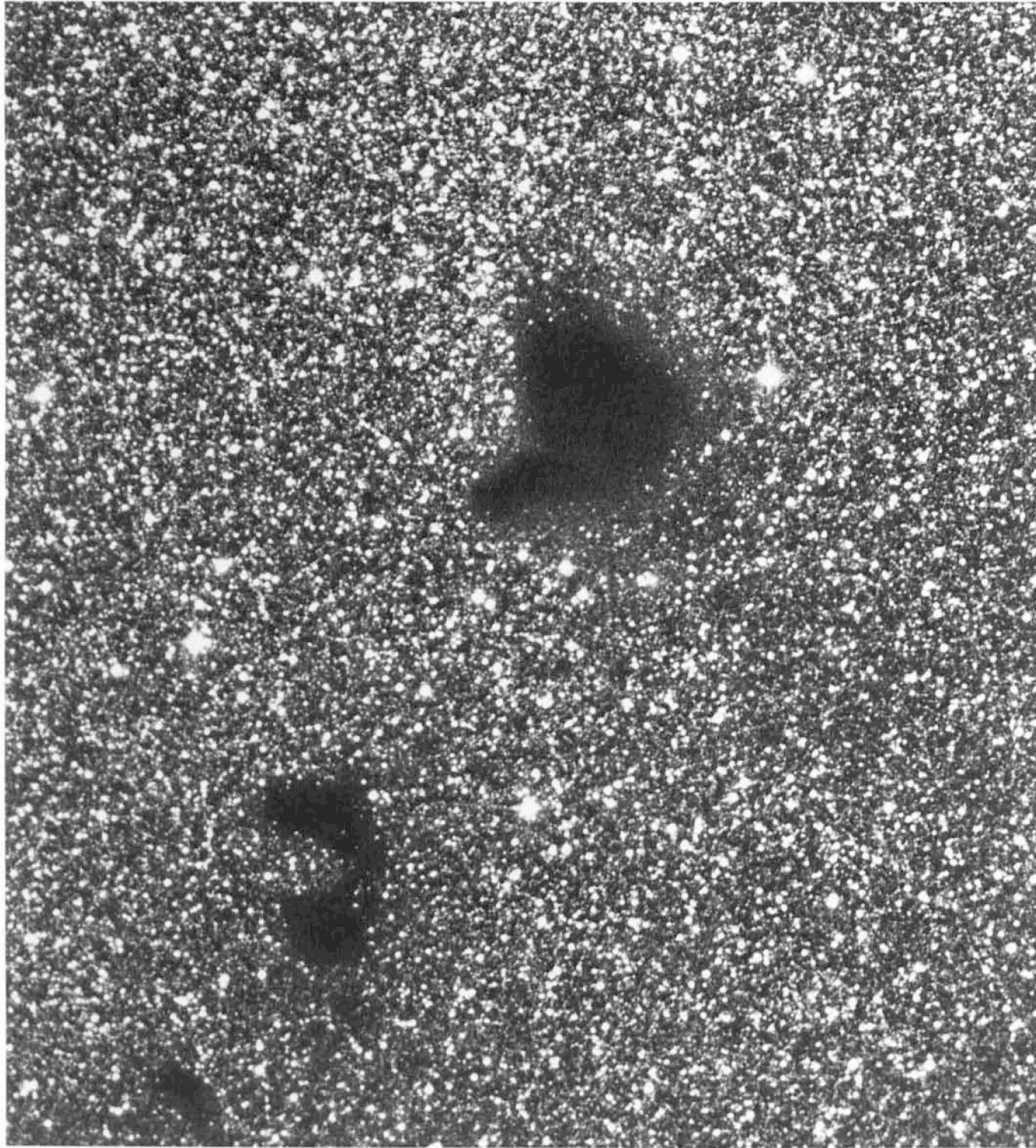

161 We find this globule in the constellation of Ophiuchus. Such globules, which are named after the Dutch-American astronomer Bart Bok (1906–1983), are small, isolated and very compact clouds, often with a strikingly round or symmetrical shape. They normally have sizes between 0.5 and 3 light-years, which is rather small when compared to an average interstellar cloud. They are usually very dense at their centres, and they therefore completely block off the light from the stars behind them. When a Bok globule is seen through a large telescope against a rich, Milky-Way star field, it looks like a dark “Hole in the Heavens” – as William Herschel described it when he first saw one in his telescope.

162 The bipolar nebula NGC 6302 has several features in common with planetary nebulae, but it is much more energetic. Its gas flows outwards with velocities of up to 400 km/s, which is ten times faster than usual in planetaries. Until now, no central star has been found in this nebula, but spectroscopic measurements have revealed that the central area is very hot and active.

NGC 6302 is very close to the galactic equator and is seen on Plate 157 as a small patch deep red in colour, because much of the light is emitted in the red spectral line of H_α and also in two red lines of nitrogen. Furthermore, it is located behind dark clouds and its light is reddened when it passes through these clouds on its way to us (see Plate 163).

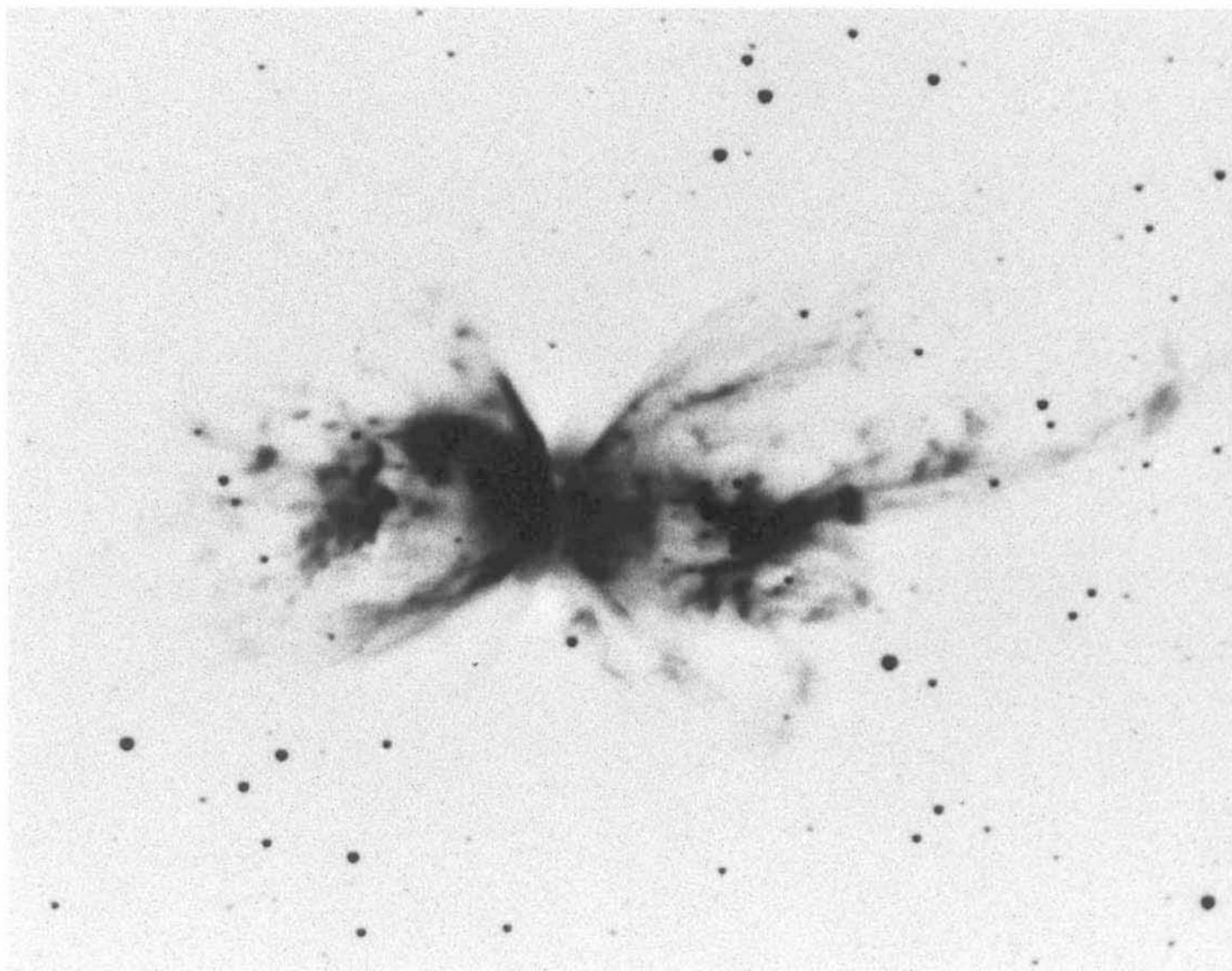



163 NGC 6334 is a small, but complex, emission nebula in Scorpius. It is in the Carina-Sagittarius spiral arm at a distance of 5700 light-years. The nebula shines with a bright red colour, due in the first place to strong emission in the H_α line, and secondly to a “reddening effect”. Reddening is caused by the selective absorption of light by interstellar matter. Blue light is absorbed about five times more strongly than red light. The interstellar matter acts like an optical filter that suppresses the blue light of a background object much more than its red light. As can be seen on Plate 157, the entire area around the nebulae NGC 6334 and NGC 6357 is filled by dark, partly transparent clouds. These clouds are at a distance of 3500 light-years and are therefore in front of the two nebulae. In the case of NGC 6334, the clouds absorb 98–99% of its blue light, but only 90–95% of its red light. This is why it appears redder than it really is.

The blue stars that ionize the nebula also suffer a strong reddening effect and appear faint in this photo. They are even fainter and there are fewer of them than would be expected. However, radio measurements have confirmed that there are more hot, luminous stars in the nebula than can be seen here. The other hot stars hide within and behind very dense, dark clouds in the nebula itself. Some such clouds can easily be seen in the photo.

164 In this photographically masked picture of the south-west part of NGC 6334, we see an incredibly complex, filamentary structure. It is not yet known how such a pattern is created in the interstellar medium.

165 The nuclear bulge of our Galaxy is best seen as a whole on a wide-field photo like the panorama in Plate 122. On the present Schmidt plate the bulge is resolved into myriads of stars. The centre of the field is at -6° galactic latitude, at a point where there are few nearby stars, apart from the ones belonging to M 7 at the right. This means that the great majority of stars in this photo belong to the nuclear bulge and lie at a distance of about 28000 light-years. However, the stars seen here are still at least 3000 light-years from the galactic centre. Most of them are red giants and although they crowd the field in great numbers, this type of star is not the most common one in the bulge. We know that the bulge is also populated with fainter stars which are much more numerous than the brighter ones recorded here. When these stars are taken into account, the total stellar density in the nuclear bulge greatly exceeds that in the solar neighbourhood.

In the right-hand part of M 7, at the very edge of the plate, we see the globular cluster NGC 6453. It is at a distance of 25000 light-years, just on the near side of the nuclear bulge.



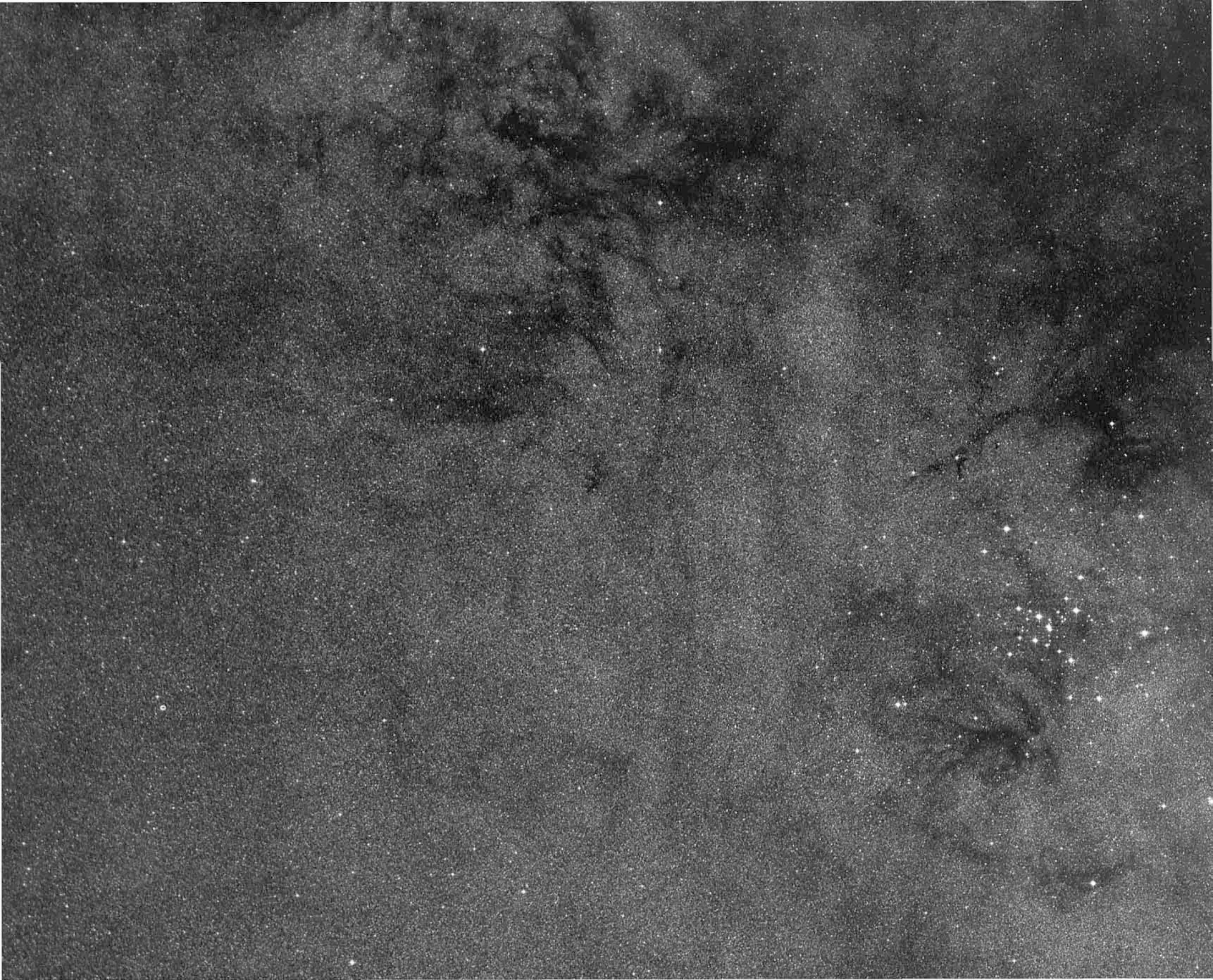

166 This is a view towards the centre of our Galaxy, which is hidden behind a dense, dark cloud (Fig. 26). Behind that cloud there are several others. Together they let so little light pass that any attempt to investigate the nuclear region by optical methods is bound to fail. But the radiation from the centre at other wavelengths is fortunately able to pass through the clouds. From numerous radio and infrared studies, we have begun to learn the true nature of the mysterious nucleus at the centre of our Galaxy.

More than any others, radio astronomers have made decisive contributions to our understanding of the complicated structure of the central region. Early studies in the 21-cm wavelength of neutral hydrogen revealed the presence

of a central rotating disk. Outside it there are a number of isolated condensations, which have apparently been ejected from the centre at high speeds. At a distance of 10000 light-years from the centre, a spiral arm in the galactic disk is moving outward with a speed of 53 km/s. Observations of other spectral lines in the radio region have mapped large clouds of interstellar molecules, such as CO, OH and H₂CO. Many of these clouds seem to lie in an expanding ring, symmetrically arranged around the centre, and which has a radius of 800 light-years.

From radio continuum measurements, it has long been realized that the strong Sagittarius A radio source is associated with the galactic nucleus. Improved angular resolution has split the

source into two, Sagittarius A East, which is probably a supernova remnant with a diameter of 30 light-years, and Sagittarius A West, a spiral-shaped structure of radio emission from ionized gas about 10 light-years across. Recent observations with very high resolution have further revealed a compact radio source, called Sgr A*, in the middle of Sagittarius A West. Sgr A* is coincident with an infrared source and is now considered to be the true nucleus of our Galaxy.

Sgr A* is very compact, its radius is too small to be determined with current radio and infrared techniques, but it must be smaller than 10 astronomical units, that is approximately the orbital radius of the planet Saturn. It has been suggested that Sgr A* is a black hole surrounded by a so-

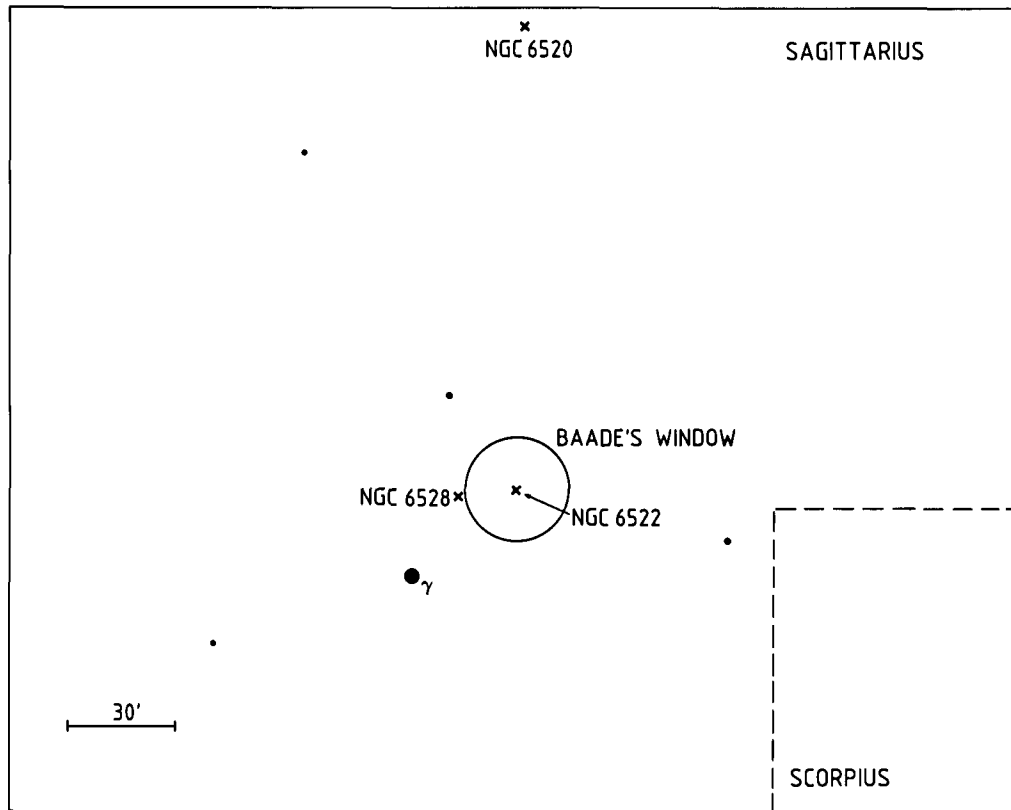

Fig. 25

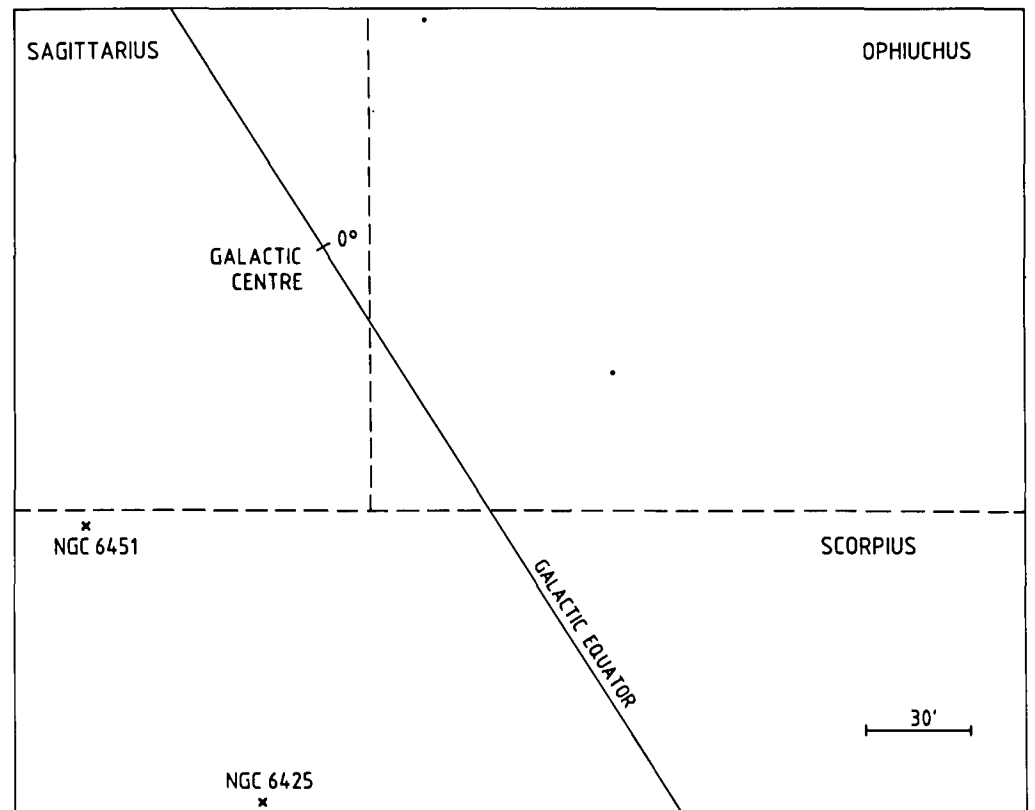
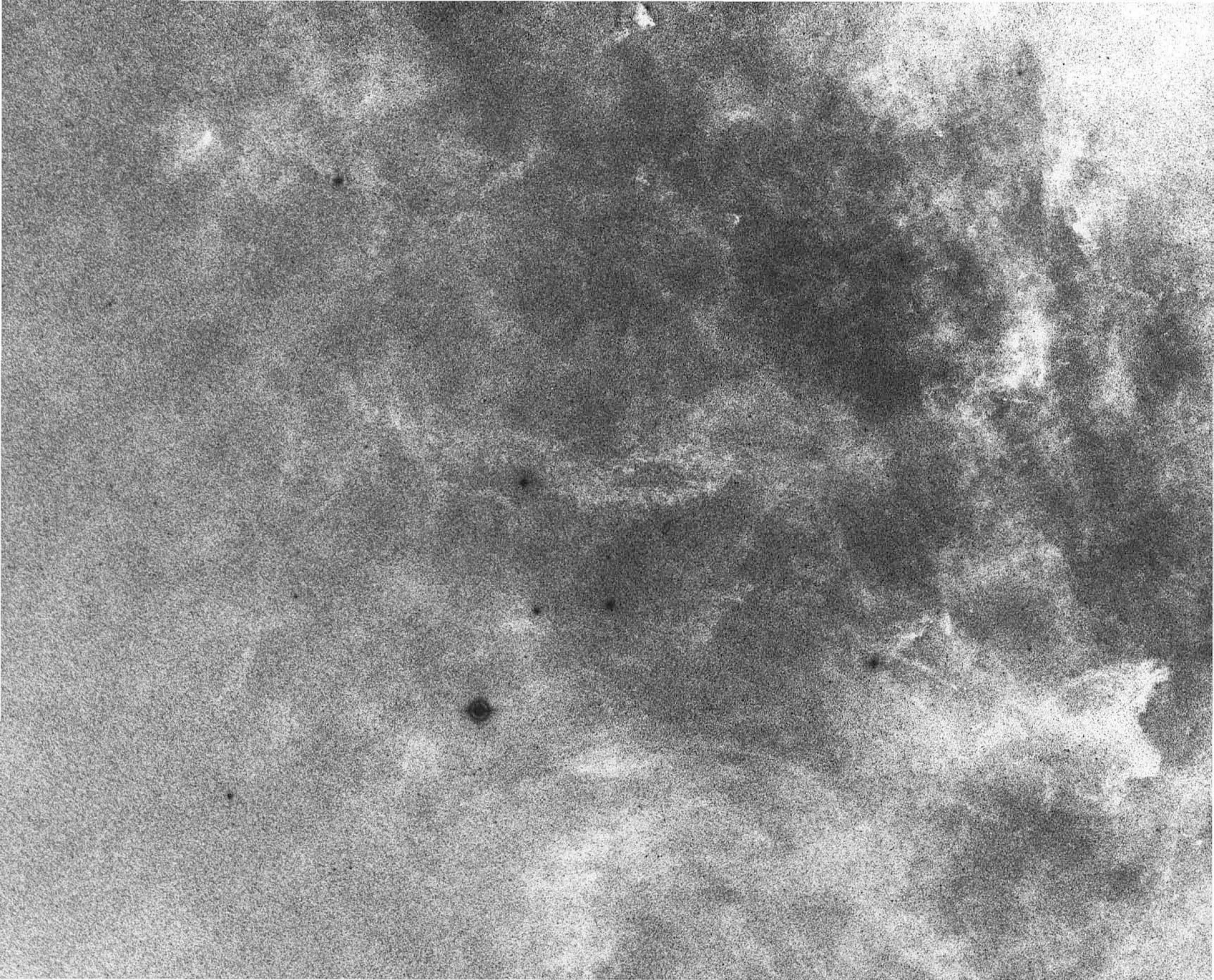
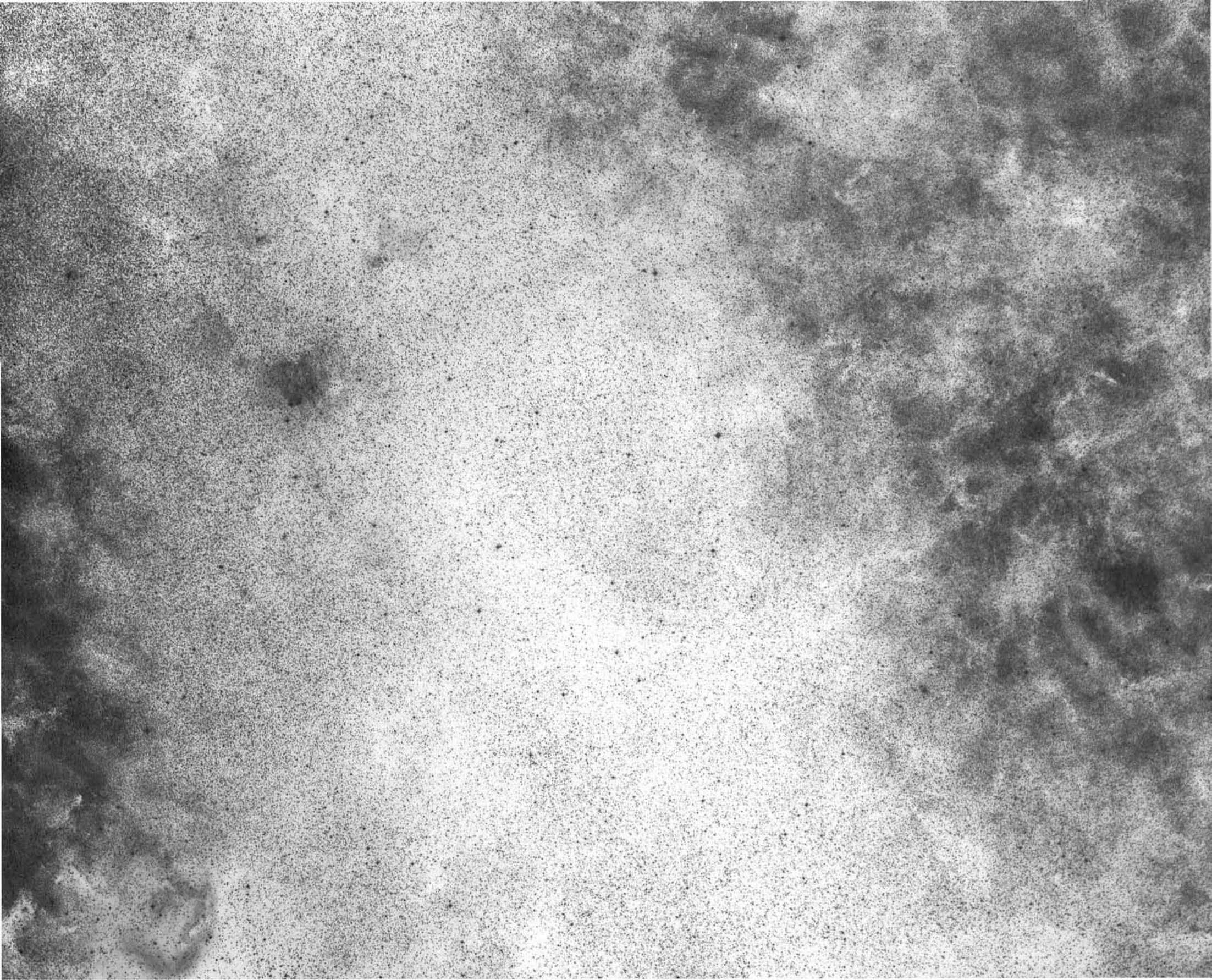

Fig. 26





called accretion disk, a rotating disk from which matter streams into the black hole. The black hole itself is by definition invisible, but radiation in a large range of wavelengths can be expected from the accretion disk. Although Sgr A* is unique in the Galaxy, it is similar to the nuclear radio sources of other galaxies, for instance the one in the Sombrero Galaxy (Plates 16–19).

It is not inconceivable that the properties of the nucleus of the Galaxy are similar to those of the quasars, but on a much smaller scale (Plates 119–120).

167 This field is a continuation of the field on Plate 166 (Fig. 25). It is a transitional area where we move from the disk of our Galaxy, which is dominated by absorbing clouds, to unobscured regions outside the disk where we see the distant stars of the nuclear bulge. Whereas we find half a dozen globular clusters in this field, there is not a single open cluster here. One globular cluster and the area around it is of special interest, because this is where the famous *Baade's Window* is situated. The German-American astronomer Walter Baade (1893–1960) noticed that the area of sky around NGC 6522 is exceptionally rich in stars. He correctly concluded that it is a relatively unobscured area in the disk, where the distant stars in the nuclear bulge, in particular the red giants, can be observed. This is a true window, in which the bulge can be observed optically to within a distance of only 2200 light-years from the nucleus. However, due to the enormous crowding of stars in the window, such observations are not easy.

168 This picture illustrates a classical method of stellar investigation. It shows a Milky Way field around the Omega Nebula, M 17 (just north-east of the centre), and the M 18 stellar cluster (below the centre), as photographed through a prism with the ESO Schmidt telescope. Since this prism is placed in front of the telescope, the technique is known as “objective-prism photography”. The light from each star is dispersed by the prism into a short spectrum; with this particular prism and photographic plate, the upper end of the spectrum is at 5500 Å in the green region, where the spectral sensitivity of the photographic emulsion rapidly falls off. The lower end of the spectrum is around 3000 Å, in the ultraviolet; the terrestrial atmosphere is opaque at shorter wavelengths. During the 2-hour exposure, the telescope was moved slowly in the east-west direction so that the spectra were widened.

Upon closer inspection, it is easy to see lines in the stellar spectra. They are caused by the absorption of light at particular wavelengths in the outer layers of the stars. From the exact position of a line in the spectrum, it is possible to deduce which atoms caused it and consequently, an analysis of the absorption lines in the spectra will tell us the chemical composition of the stars. However, a star's spectrum is even more dependent on its temperature. The appearance of these spectra, therefore, first of all allows us to classify the stars by their temperature.

In general, cool stars have spectra with many absorption lines and hot stars have spectra with few lines. Most spectra of cool stars have two strong lines very close to each other in the middle of the spectrum; they are caused by atoms of ionized calcium in the stellar atmosphere. In the spectra of hot stars, the lines are progressively closer spaced towards shorter wavelengths; these lines are all caused by neutral hydrogen. Note

also some spectra with dark (emission) lines near the top end. Such spectra indicate that the star possesses an envelope of hot gas. One of these objects is near the centre of the picture – there is another near the middle of the right edge.

169 M 8 or NGC 6523 is also called the *Lagoon Nebula*, a name derived from the broad dust lane that crosses the nebula. It is a bright, extended emission nebula containing the galactic cluster NGC 6530, which is at the centre of the Sagittarius OB1 association. The distance to NGC 6530 has been determined as 6000 light-years, and the cluster is only 2 million years old, very young in astronomical terms.

The brightest star on this Plate is 9 Sagittarii, a hot O-type star. It is responsible for much of the ionization of the nebula, including a number of bright rims that face the star. The core of the Lagoon nebula is the *Hourglass Nebula*, here just weakly visible to the right of the dust lane. The Hourglass Nebula is extremely young, probably no more than 10000 years old, and the equally young star next to the nebula, called Herschel 36, heats the Hourglass Nebula. Herschel 36 is a new-born star now emerging from its parent cloud, but which is still very obscured.

In several respects, the Lagoon Nebula is similar to the much closer Orion Nebula (Plate 127). Here too, a dense, cold molecular cloud has been found behind the nebula, and the edge of this cloud is being attacked by the strong ultraviolet radiation from the hot NGC 6530 stars. The evaporated material is the hot and luminous gas that streams away from the cold cloud.

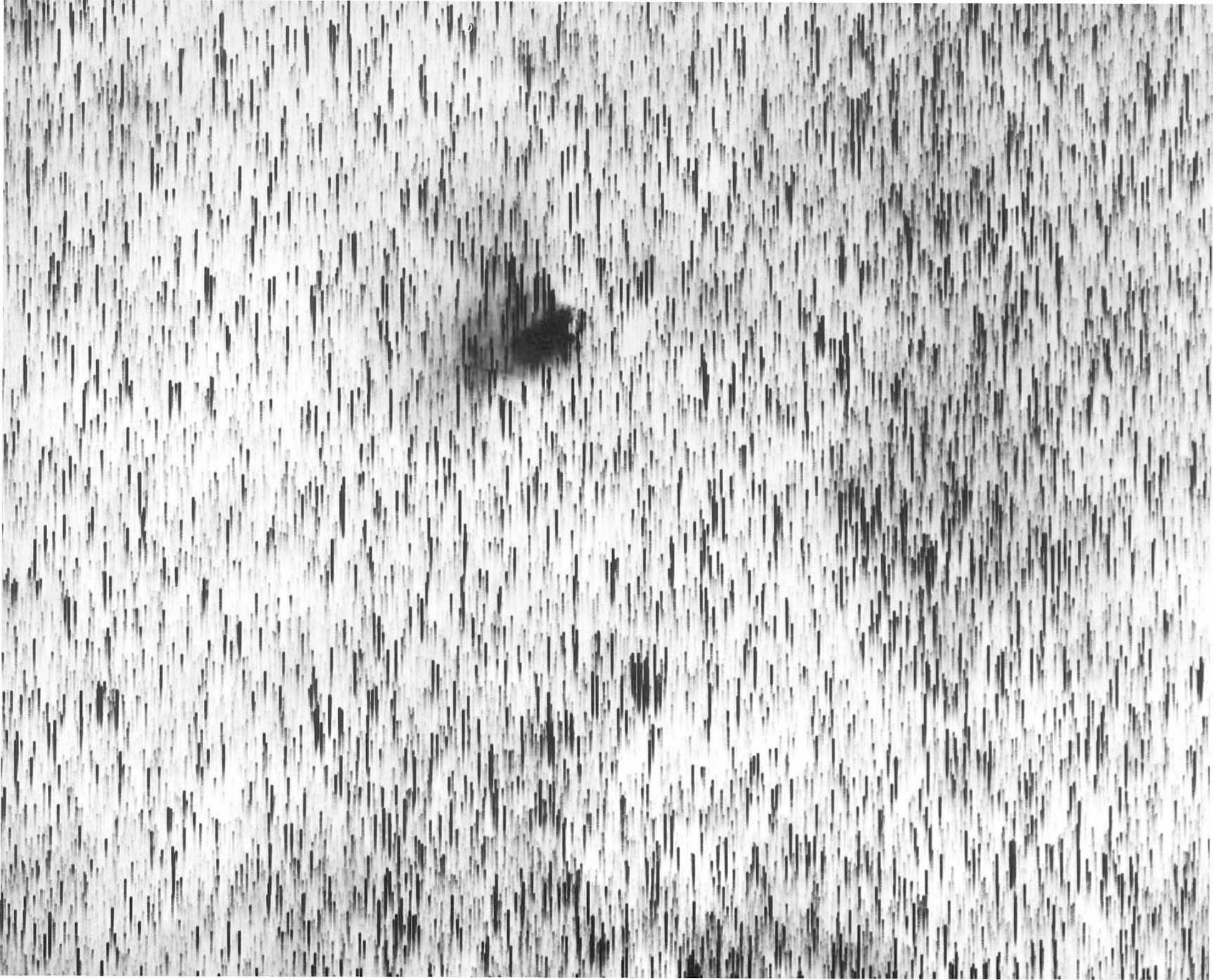

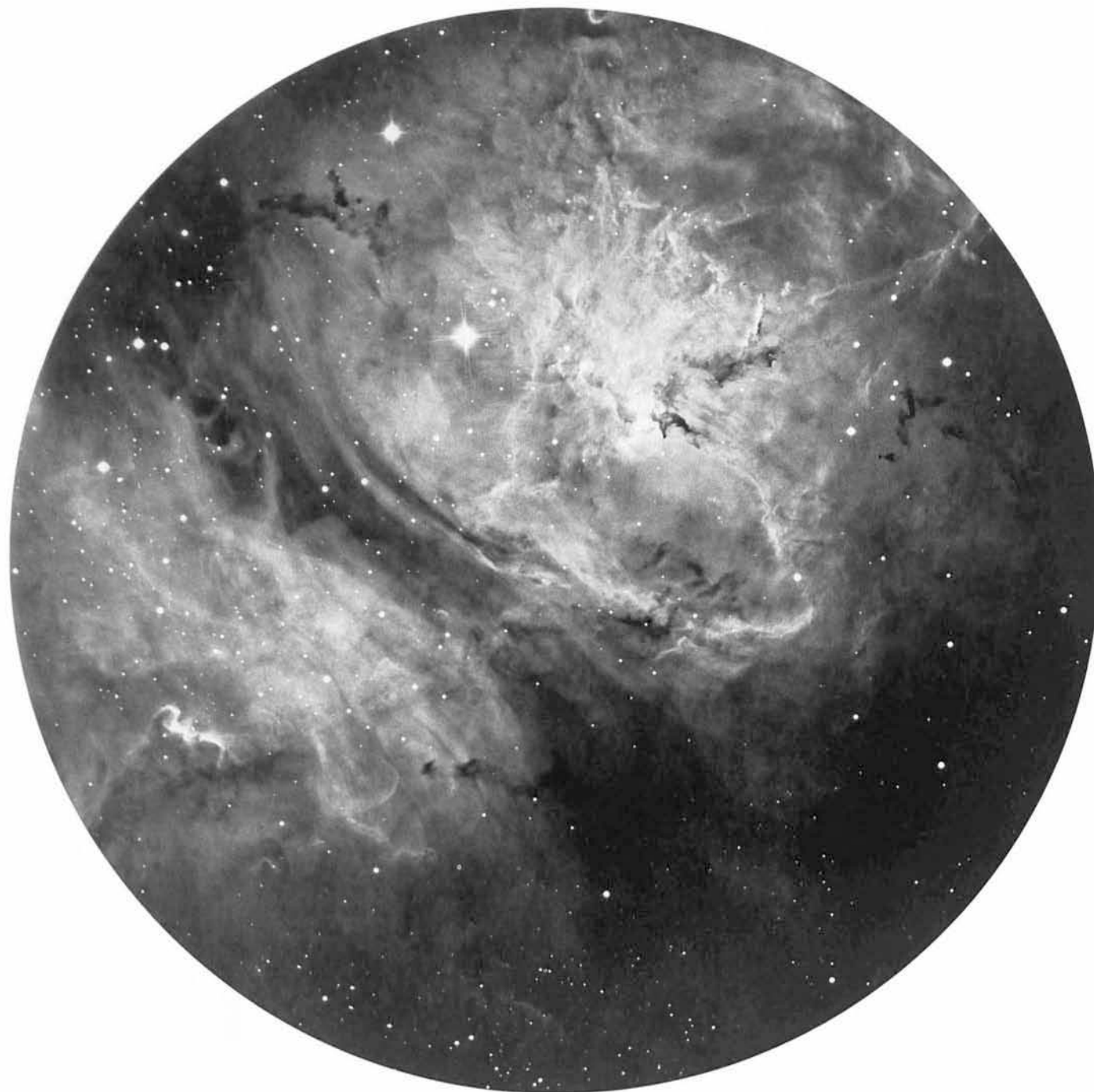

170 On this Schmidt-telescope plate, which was exposed in red light, we see the full extent of the Lagoon Nebula. It is a large object, and the stellar cluster previously mentioned, NGC 6530, is here near the centre of the nebula, whereas most cluster stars are outside the brightest area shown on Plate 169. The large nebula is surrounded on three sides by lanes of dark clouds. To the east it has an extension, a broad but faint band of nebulosity with a number of brighter spots, of which some are emission nebulae and others are reflection nebulae.

The entire area can be described as a huge dark cloud of gas and dust, some areas on the front of which are made visible by illumination from stars. Some of the starlight is reflected by dust particles and produces a reflection nebula, and some ionizes the gas and produces an emission nebula. In some places new stars are born, and among these a few, very hot ones, ionize huge areas of gas and produce the large, bright nebula that we observe as the Lagoon Nebula.

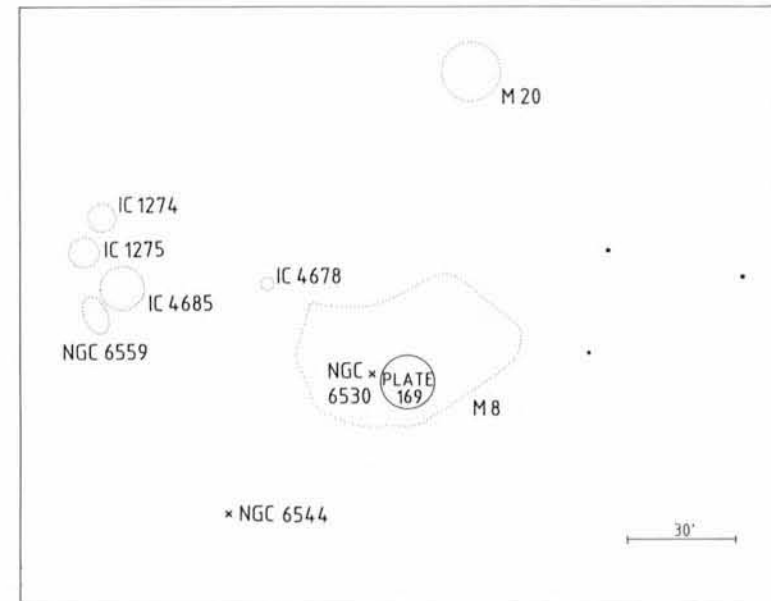





171 M 20 or NGC 6514 is also called the *Trifid Nebula*, since dark lanes of dust clouds within the nebula appear to divide it into three parts. It is an example of a Strömgren sphere (see Plate 58). Near the centre, to the left of the dark lane, there is a small cluster of very hot stars. These stars emit a lot of ultraviolet radiation, which maintains the ionization of the surrounding nebula. At a certain distance from the stars all the UV radiation has been absorbed in this process. All gas outside this border therefore remains neutral. Such a radiation-limited nebula has a sharp boundary between it and the surrounding neutral gas.

172 In Sagittarius, close to the galactic equator, we encounter the red nebula M 17, also named NGC 6618 or the Omega Nebula (see also Plate 168). It has a beautiful red colour, which grades into rose-coloured and white in the hottest areas. In this photo the white area is not just a matter of overexposure. In the hottest part of the nebula, the intensities of the differently coloured spectral lines emitted by the gas are distributed in such a way that the resulting visual impression is one of white light.

The structure of M 17 is similar to that of the Orion Nebula. A strong infrared source and a molecular cloud have been detected southwest of M 17. The cluster of hot stars that heat the gas is less impressive here, and the formation of new stars appears to have come almost to a standstill.





2.6 *Milky Way Objects at High Galactic Latitude*

The Milky-Way objects that have been described so far are all in or near the disk, and are therefore seen in the band of the Milky Way. However, some types of objects are situated outside the disk and are distributed over a much larger volume. For instance, the space occupied by the globular clusters is nearly spherical and their density decreases with the distance from the galactic centre.

This is why we see so few of them in the northern sky, while we find more than one hundred in the general direction of the galactic centre. In addition to the globular clusters, the very old halo stars also occupy a moderately flattened volume. Other types of stars and the planetary nebulae have an intermediate distribution and may also be encountered at high galactic latitudes. The following plates show a selection of globular clusters and planetary nebulae which are situated outside the band of the Milky Way.

173 At a galactic latitude of -24° , in Sagittarius, we find the globular cluster M 55 or NGC 6809, which is here shown in colour. The general impression of its colour is red or orange. The brightest stars in globular clusters are red giants. They are evolved, moderately massive stars that have run short of fuel. At this late stage of their lives, they spend a relatively short period as red giants before their luminosity begins to decrease and they slowly fade into insignificance. They are sufficiently numerous to give the globular cluster its reddish colour. No blue giants are found here, and there is no interstellar gas and dust. The formation of stars in globular clusters ceased billions of years ago.

The determination of ages of globular clusters of our Galaxy is subject to considerable uncertainty. There is no doubt, however, that they are very old; according to modern measurements most are in the range between 10 and 16 billion years. They were among the first objects to be created when our Galaxy was formed. They cover a wide range in mass and luminosity, from the equivalent of a few thousand Suns, up to a few million. M 55 is a moderate-sized globular cluster of less than 100 000 solar luminosities. It is a 7th-magnitude object at a distance of 20 000 light-years.

174 Like several other globular clusters, this giant one in Centaurus, NGC 5139, was originally named as if it were a star. It is called ω Centauri, and on the panorama (Plate 122) it appears as a fourth-magnitude object, 15° north of the galactic equator. Its central part is very dense and luminous; this is why it can be mistaken for a single star. In reality it is a huge cluster, with a diameter of more than one degree, or more than twice the diameter of the Moon. It is significantly larger than the field shown in the present photo. Its outer parts are quite sparsely populated, but the total number of member stars still adds up to several millions.

ω Centauri is an old cluster, about 15 billion years old according to recent determinations. It was formed very early in the history of the Galaxy, at a time when the matter in the Galaxy was a nearly pure mixture of hydrogen and helium, with only a very small percentage of heavier elements. At this very early time, only a few supernovae had exploded, and the gas had not yet been significantly enriched with elements like oxygen, nitrogen, etc. This purity can still be recognized in the atmospheres of the ω Centauri stars, where the metal content is only a few percent of that in the Sun.

ω Centauri is one of the globular clusters with the most variable stars. Periods have been determined for close to 200 of these stars; most of them are of the so-called RR Lyrae type. Like the Cepheid variable stars (Plate 37), these stars are particularly valuable because they can be used for distance determination. From the measured light variation, the intrinsic luminosity of an RR Lyrae variable star can be calculated with good accuracy. It is then a relatively simple matter to find their distance on the basis of their apparent magnitude. The distance to ω Centauri has been determined as 16 500 light-years by this method.

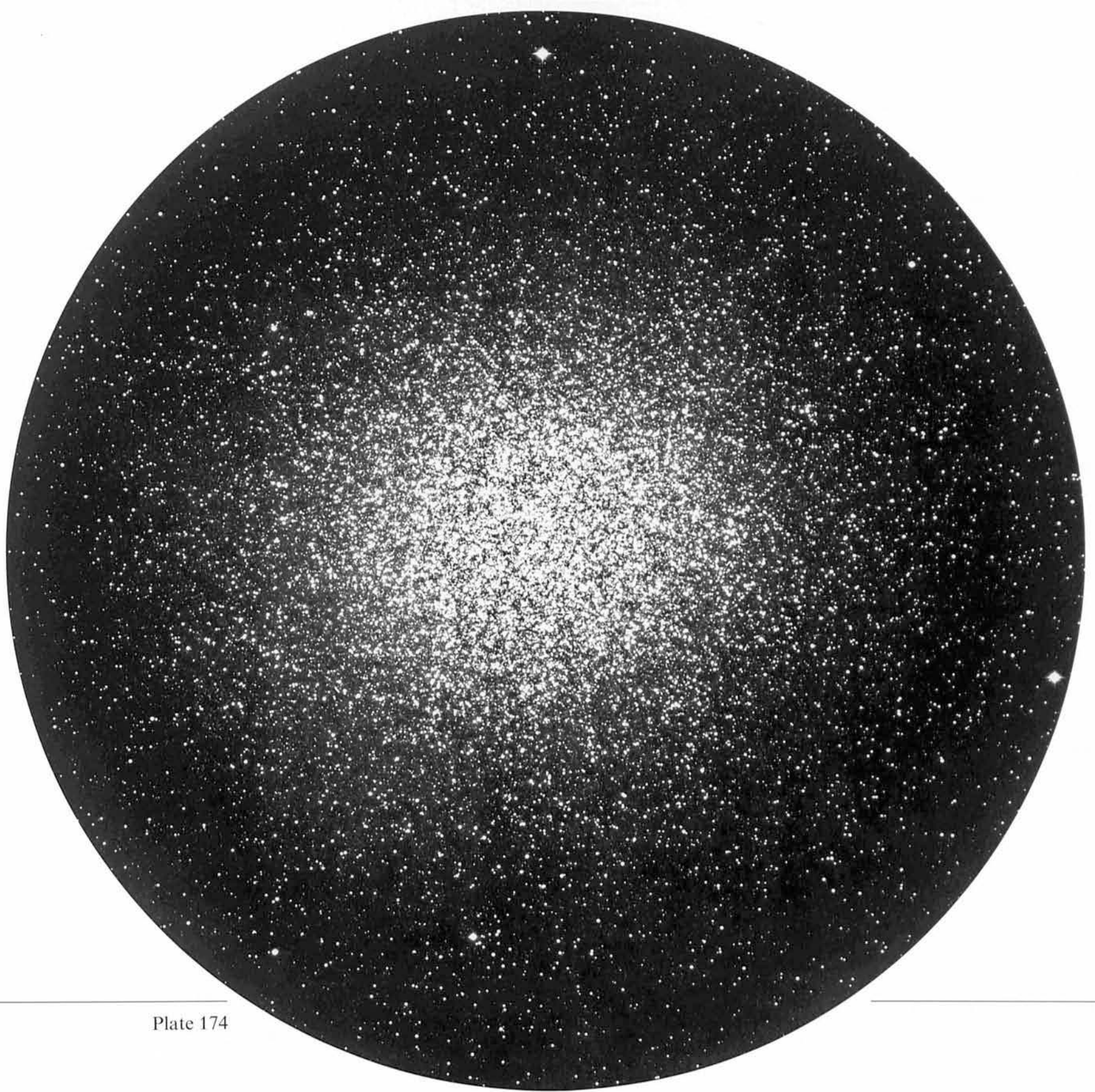



175 Far south in the constellation of Tucana and close to the Small Magellanic Cloud, we find NGC 104 or 47 Tucanae. After ω Centauri it is the second brightest globular cluster in the sky, and to the naked eye it appears like a star of fifth magnitude. It was one of the pioneer observers of the southern sky, the French astronomer Lacaille (1713–1762), who first recognized that it was a cluster and not a single star.

47 Tucanae is so far from the Milky Way that the foreground stars are few. It is also well separated from the SMC, and there are few SMC stars in this field of the sky. It is, in other words, fairly easy to select cluster stars, because most stars seen in this area are members of the cluster.

The 47 Tucanae globular cluster lies at a distance of 13000 light-years and it has a number of interesting features. It is among the “younger” globular clusters; about 10 billion years old, and its stars have a fairly high content of heavy elements. Its metal content is ten times higher than that measured in older clusters, but still three times lower than the metal content in the solar atmosphere. This large difference between old and young globular clusters has puzzled astronomers considerably. It means that the metal enrichment of the interstellar medium during the first few billion years after the formation of the Galaxy must have been more efficient than was previously thought. Heavy elements, including the metals, are produced deep inside massive stars at a late stage in their evolution. The most efficient way of moving the metals from the stars into the interstellar gas is by means of supernova explosions. It is now assumed that supernovae were fairly frequent during the early life of the Galaxy. These first supernovae effectively produced gas with heavy elements out of which new generations of stars were formed.

176 Far from the galactic equator, in the constellation of Grus (the Crane), we encounter this pretty, somewhat diffuse, planetary nebula, IC 5148/50. Its central star stands out clearly and the form of the nebula is very regular. Its shape in space is most likely to be a shell, or possibly two shells, of which the inner one is slightly elongated in the north-south direction.



177 The *Helix Nebula* or NGC 7293 is situated in Aquarius at a latitude of -57° . To visual observers, even to those who use a medium-sized telescope, the Helix Nebula is not particularly impressive. It is large, with an angular diameter about half as large as the disk of the Moon. It has a green hue and one does not see much structure. However, photographic techniques reveal its complicated fine structure. This is particularly true when using a film sensitive to the red H_α line; the human eye is insensitive to faint light of this colour. But best of all, colour photography shows the full beauty of the Helix Nebula. The present colour photo is a composite of three black-and-white exposures in the telescope, as described on page 2.

In the nebula itself, the sequence of colours from the central star outwards is a measure of the intensity of the ultraviolet radiation from the star. Close to the star, the colour is violet because the intensity here is sufficient to ionize neon and oxygen. At the outer edge the intensity is less and the deep red H_α line is dominant. In the intermediate zones the colours are mainly blue and pink; they are produced by a mixture of emission lines from hydrogen, helium, nitrogen and oxygen.

The three-colour superimposition method is nicely illustrated in the photo. Quite accidentally, a minor planet in the Solar System was located in this direction when the exposures were made at the telescope. This object is named "Irene" and is number 14 in the list of minor planets. Since it was moving south-west, the colours are separated along a short trail that points in this direction. The first exposure was obtained in blue light, the second in green light, and the third in red light.







3 Minor Bodies in the Solar System

178 The famous Comet Halley was photographed in the southern constellation of Sagittarius on March 21, 1986. At this time it was moving towards the band of the Milky Way. It had a long, straight gas tail, the outer parts of which are lost in the glare of the Milky Way. The bright object to the right of the Milky Way is the overexposed image of the planet Mars. Compare this photo with Plate 157–158. The orientation of this picture can be seen in Fig. 24.

The previous pages contain many examples of regions in which stars are formed, and we must assume that our own Sun, like any other star, was born in such an area. And yet, the investigations of the events that led to the formation of this particular star and the planetary system around it have a special importance for us. Looking back through billions of years, to the time when the young Sun was about to emerge from its cloud, we try to get a glimpse of our own origin. It is not surprising that many current efforts in observational and theoretical astrophysics are directed towards the understanding of the processes that took place when the Solar System was born.

The minerals in the Earth's crust can be dated by radioactive methods and it has been found that the oldest rocks have ages of about 4 billion years. Slightly higher ages are deduced for some lunar rocks and for some of the meteorites that have fallen on Earth. Combining this knowledge with theoretical investigations of the evolution of the Sun, there is a general consensus that the Solar System was formed 4.5–4.6 billion years ago. At that distant epoch, a small region with gas and dust in interstellar space became denser; it may well be that this was caused by the pressure from an exploding supernova nearby. When a certain density had been reached in the small cloud, its own gravitation led to further contraction, and the Sun was ultimately formed by condensation at the centre. The surrounding cloud was flattened by slow rotation and we must assume that the major planets and many smaller ones were formed from local condensations in this disk. After a relatively short time, perhaps only about 10 million years, much of the remaining gas and dust had been swept up by the planets. Then came a period when the major bodies in the Solar System collided with most of the smaller ones, but once this was over, the remain-

ing planets settled down on their own, individual paths. For reasons that are not fully understood, our Earth was the only planet that came to harbour biological life and that was able to protect it long enough for human beings to emerge as the most complex life-form.

Our Solar System is thus a relative newcomer in the Universe. Its age is only about one third of that of the Universe. The Sun is an entirely normal star of intermediate size, which, according to our computations, has now lived through half of its expected life. During this time, it has been burning hydrogen into helium, and the matter of which it was formed has now been significantly changed. The same is true of the inner planets, where geological processes have left little, if any, of this original material. Even the surface of the Moon was completely transformed during its early history.

Therefore we must turn elsewhere if we want to find samples of the original material of which the Solar System was formed. We must look at the most "primitive" bodies in the Solar System, which still contain such material. These are, first of all, the *comets* and the *meteorites*, but most likely also many of the *minor planets*. Recent years have seen an increased, scientific interest in these minor bodies of the Solar System, and related ground-based as well as space-based research has given us important new insight into our own origins.

3.1 Meteoroids and Minor Planets

Most people who have had the opportunity to observe the night sky from a dark site have also seen a "shooting star", or *meteor*, which appears as a fleeting streak of light in the sky. More rarely, a really bright "fireball" moves across the sky, leaving a long trail behind. Some of these fireballs are so bright that they can be seen during daytime. These events are all caused by meteoroids, solid pieces of rock from space that glow because they are heated by friction when they enter the Earth's atmosphere. Most meteoroids are too small to survive and they burn up entirely, but some of the larger ones fall to the surface, where they can be found and analysed.

Since 1957, there are also *artificial satellites* in the sky. They can be seen as a moving, bright point, sometimes of variable intensity. On astronomical photographs, they produce long, straight lines during the exposure, and it can be difficult to distinguish them from meteor trails. Normally meteors have shorter trails which are rather uneven. This is because of the rapidly changing rate of vaporization as the meteor moves through the increasingly dense layers of the atmosphere.

Most *minor planets* cannot be seen with the naked eye and as they are much farther away than both meteors and satellites, they move much more slowly across the sky and their trails on astronomical photographs are much shorter. Most of the minor planets have orbits between the planets Mars and Jupiter. Their orbits are normally close to the Ecliptic, that is the orbital plane of the Earth. Trails of minor planets are therefore mainly seen in those areas of the sky that are near the great circle of the Ecliptic.



179 This multiple, bright meteor trail was recorded photographically during a two-hour exposure with the ESO Schmidt telescope. A relatively large meteoroid, perhaps weighing a few hundred grams, entered the Earth's atmosphere and due to friction with the air molecules, its surface was rapidly heated. At some point, the meteoroid broke into several pieces, which continued their fall along parallel lines. The picture shows a small portion of at least six trails; another very faint one is seen east of the brightest part. Note how the intensity changes along the trails as they cross the field, which contains a distant cluster of galaxies in the constellation of Eridanus. The bright galactic star at the bottom is of course far beyond the meteor, but the fact that its image is more intense ("whiter") than the trails leads to a well-known optical illusion by which it seems to be in front of the meteor.

180 The straight, unbroken line that crosses this photo from top to bottom is not a meteor trail, but an artificial satellite. The intensity is relatively constant along the trail, indicating that either the satellite rotates very slowly or that it has a spherical shape. A second satellite, which moved in an east-west direction, is rotating relatively fast and its trail shows a regular pattern of intensity variations. The moments of maximum light occur when a small area on the satellite's surface reflects the sunlight directly towards the telescope. Since the satellites may have ap-

peared in the field at any time during the two-hour exposure, in practice it is not possible to identify them. Also the speed with which they moved cannot be inferred from the trail alone.

Nowadays, most wide-field photographs contain one or more satellite trails. Although they are not normally detrimental to the astronomical research done with these plates, the sheer number of Earth-orbiting satellites and space debris recorded this way is a serious reminder of the rapidly increasing "pollution" of space.

181 The first minor planet (or "asteroid") in the Solar System was found on January 1, 1801. It was named "Ceres" and now figures as no. 1 in the official list of minor planets, which by mid-1987 contained no less than 3600 such objects. Ceres has a diameter of about 1000 km and is the largest of them; the smallest known are no more than large boulders, which measure around 100 metres across. Since the end of the last century, searches for minor planets have been based on the discovery of moving objects on photographic plates.

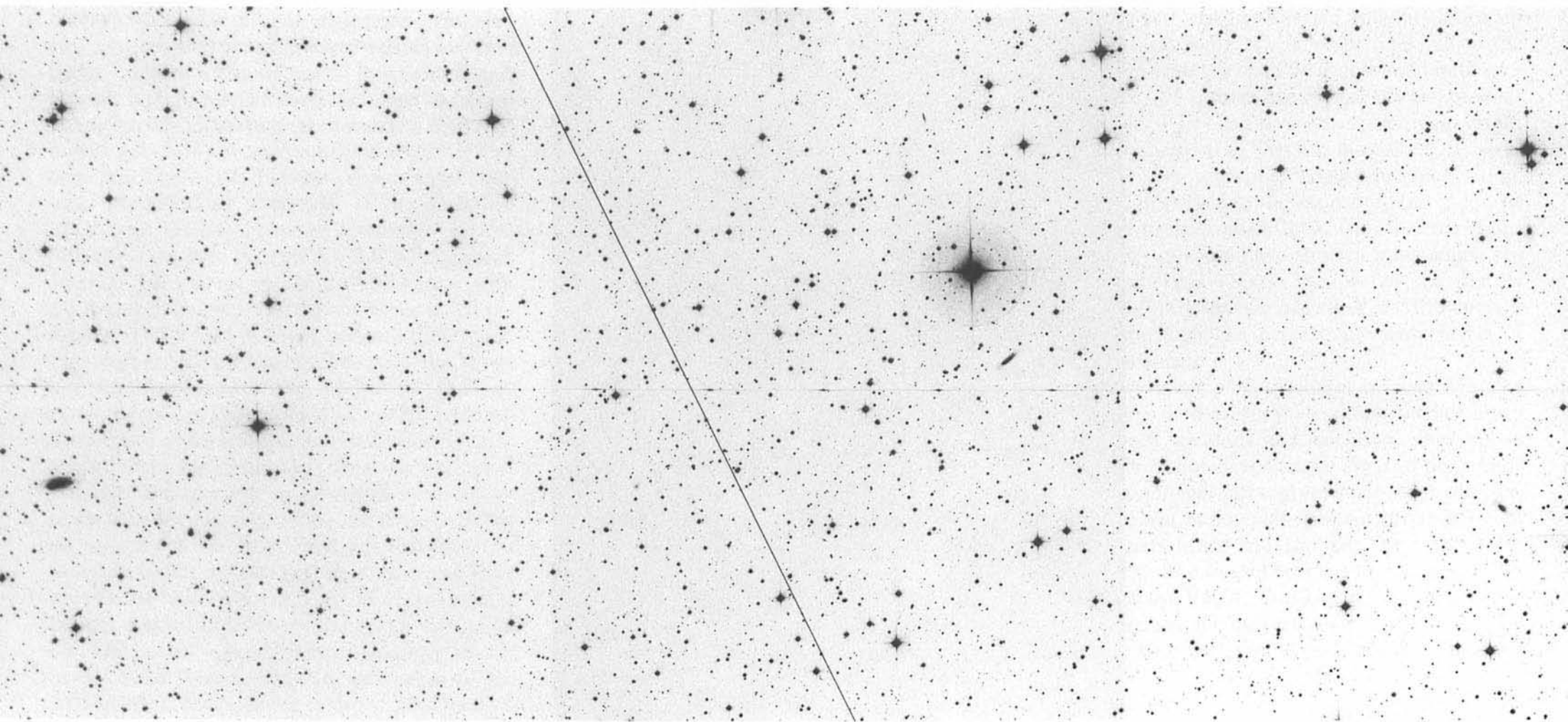



Two techniques are used. The first one consists in comparing two short-exposure plates of the same field of sky, obtained on consecutive nights. Whereas the stars remain fixed, a minor planet will have changed its position in the meantime. It can therefore be identified as a moving, star-like point. The other method is simpler: when the exposure time is long enough, the moving minor planet appears as a short trail. If a similarly oriented trail is seen on later plates, it cannot be that of a meteor, it must belong to a minor planet.

This picture illustrates the discovery of a fast-moving minor planet. On October 2, 1975, a photographic plate was obtained with the ESO Schmidt telescope of the field around the Sculptor Dwarf Galaxy (Plate 68). A long trail was seen, near the very centre of this galaxy. Another plate, taken two days later, confirmed that the trail was that of a fast-moving minor planet. Indeed, it moved so fast that no further plates could be obtained. Fortunately, this object was again discovered in 1978 at the Palomar Observatory. It then became possible to calculate its orbit and it was given the number 2100 and the name "Ra-Shalom". It belongs to a very special

class of minor planets with small, elongated orbits that are almost entirely inside the orbit of the Earth. In the point of its orbit that is closest to the Sun (the perihelion), it is just outside the orbit of Mercury. (2100) Ra-Shalom was about 24 million km from the Earth when this picture was made.

182–185 Although most known minor planets move in orbits between Mars and Jupiter and therefore never approach the Earth, a few have very different orbits and may come much closer. In Plate 181 one of these was shown when it was 60 times more distant than the Moon. Others come even closer, and it is quite reasonable to believe that the Earth once in a while collides with a minor planet. Several large craters on the Earth's surface bear witness to such events, which fortunately must be rare.

A near-miss happened in late 1976. On October 24 of that year, a long trail of a minor planet was found on a photographic plate, obtained at the Palomar Observatory. The object was confirmed two days later and was apparently moving with very high speed, indicating that it must be near the Earth. An announcement

was sent by the Central Telegram Bureau of the International Astronomical Union to all observatories around the world with a request for further observations of this particular object. Four photographs were obtained at ESO on the nights of October 28 (Plate 182), October 29, (Plate 183), October 31 (Plate 184) and November 1 (Plate 185). They are reproduced here at a common scale. Since all of them were made under equivalent conditions and with nearly the same exposure time, they provide a clear illustration of how the small planet rapidly recedes from Earth while at the same time its brightness decreases.

Tracing the motion backwards, it was found that this object passed only 1.2 million km from the Earth on October 20, 1976 – that is about three times the distance of the Moon. At the time of the first ESO picture (Plate 182), it was only 9 million km away. Its diameter is about 100 m and a collision with the Earth would have been dramatic. Since its orbit is being continuously changed by the gravitational pull of Venus and the Earth, such an event may happen in the future. It is now known as (2340) Hathor and it is one of the smallest minor planets known.



186 In 1936, a minor planet was discovered at the Royal Observatory, Uccle, in Belgium. Its orbit was found to cross that of the Earth and it was named "Adonis". It was observed for some months and then became too faint to be photographed with the telescopes then available. Forty-one years later, a determined attempt took place to "recover" this minor planet. The best possible orbit was computed on the basis of the sparse observations in 1936 and extrapolated forward to 1977. However, due to the large uncertainties involved, Adonis' position in the sky was not well known. Several observatories turned their large Schmidt telescopes towards the area of sky in which Adonis was supposed to be seen during a rather close passage to the Earth in February 1977. One trail was found by American astronomers, but it could not be confirmed because of bad weather.

This ESO Schmidt photo provided the definite proof that Adonis had indeed been found after so many years. It was obtained on February 24, 1977. The telescope was set to follow the expected motion of Adonis; this is why the stars are seen as (slightly wiggly) trails. Two exposures were made on the same plate and Adonis is therefore seen twice, as two tiny dots near the centre.



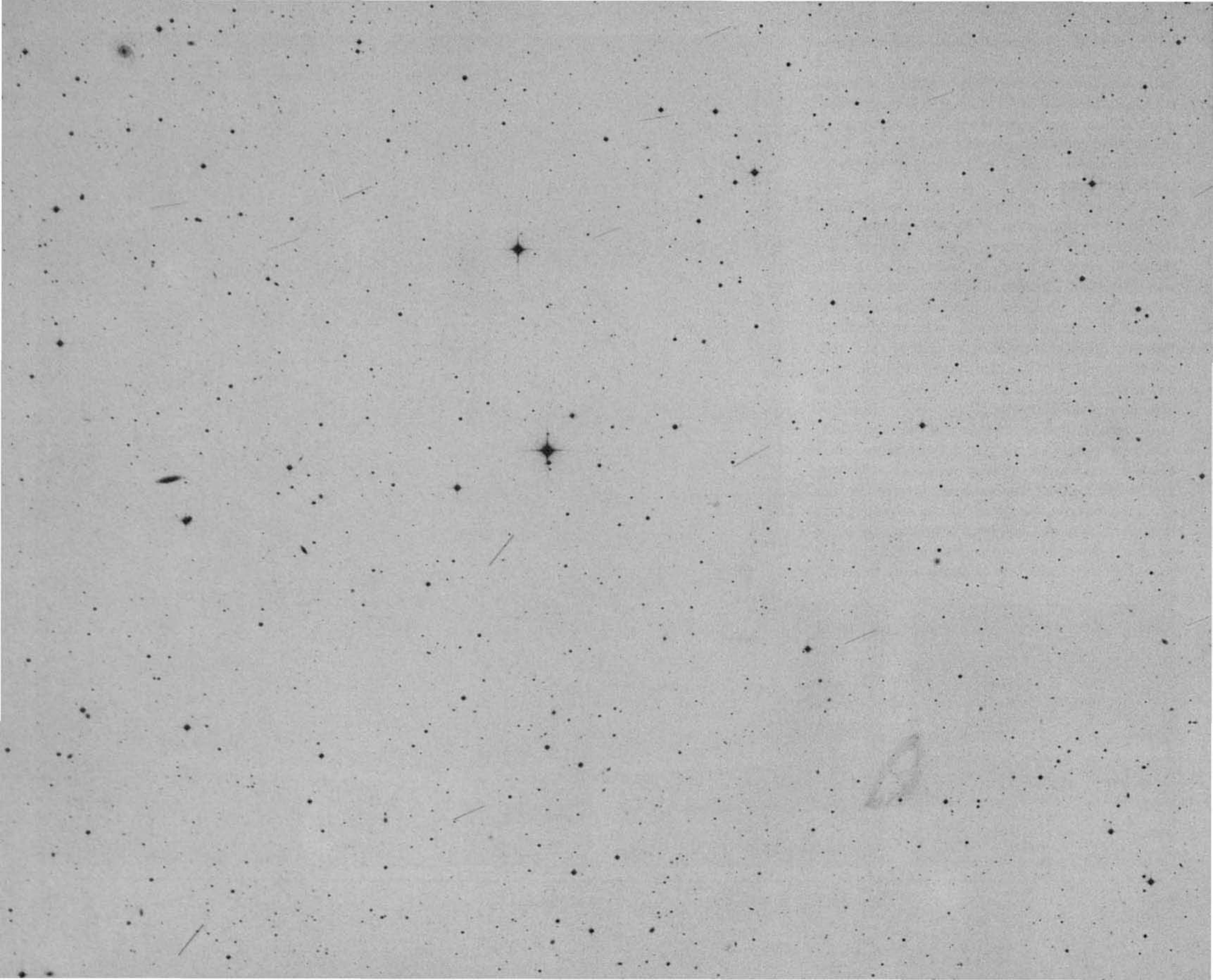

187 It is estimated that there are more than 100000 minor planets in the Solar System with diameters greater than 100 metres. Up to 1987, about 400000 positional observations had been made of 3600 numbered minor planets and an unknown number of others. Every year, accurate orbits are computed for 100–200 new ones, which are then added to the official list and receive a number.

Many of the new minor planets are found during dedicated search programmes. These are carried out by regular photographic patrol observations in selected fields near the Ecliptic. Others are found by chance during observations made in other astronomical research pro-

grammes. This colour picture is an example of the second kind. On two successive nights, deep photographic plates were obtained of the field around the comparatively bright, Sc galaxy NGC 4517. It happens to lie within a few degrees of the Ecliptic and both plates show large numbers of trails of minor planets. They were superimposed in the photographic laboratory in such a way that the first plate was given a green colour and the second, red. In this way, the trails on the first plate are green and those on the second, 24 hours later, are red. Figure 28 helps to identify the trails and also indicates the direction of motion. None of the minor planets in this field have yet received a number, and their

orbits have not been determined. However, from the speed and direction of their motions, it appears likely that they all belong to the main-belt minor planets, that is those between Mars and Jupiter.

The strange image south-west of the centre is the reflection of a bright star, outside the field.

188 When a botanist finds a new plant, he is traditionally entitled to give it a name. When a discovery is made in other sciences, the discoverer has the privilege of naming the new object. This is also the case in astronomy, although certain rules must be adhered to. For instance, in view of the unlimited number of stars in the sky, the International Astronomical Union, which is the sole organization responsible for designations of celestial objects, long ago decided that stars cannot be given names, only numbers. However, minor planets with well-determined orbits may be given reasonable names by the discoverers.

The minor planet seen at the centre of this picture, a little north-west of a galactic star, is a rather faint object. It was originally found on this short-exposure plate, obtained with the ESO Schmidt telescope in 1976, by comparison with other plates taken on following nights. The faint dot was moving and could therefore unambiguously be identified as a minor planet. At that time it was given a preliminary designation: "1976 UH". More observations became available in the next year and in December 1979. It was given the number 2187 in the official list. Soon thereafter, the ESO astronomer who discovered it decided to name it after the mountain on which the ESO observatory is located. This minor planet now carries the name "La Silla".

Quite apart from the pleasure of discovering new objects in the Solar System, this type of research also has other aspects. In order to investi-

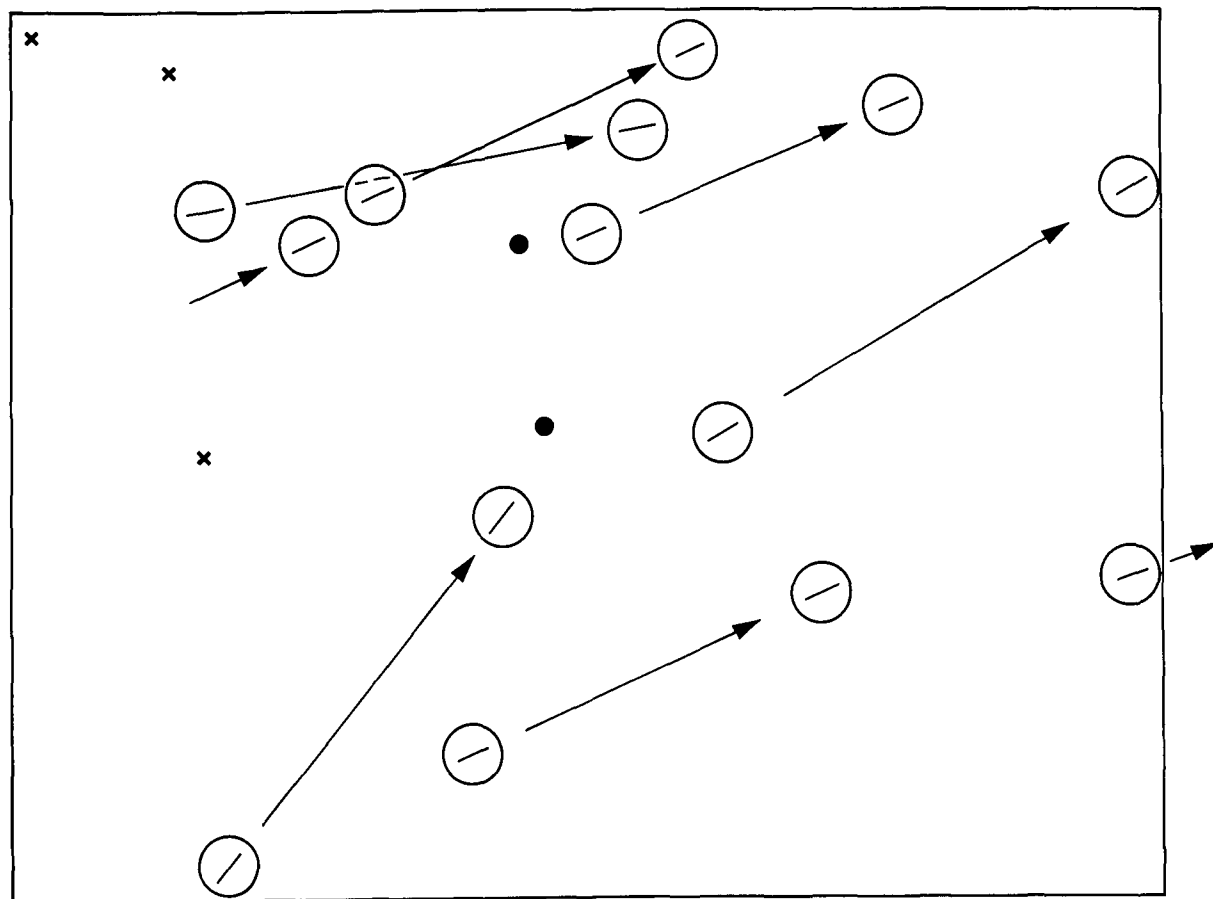

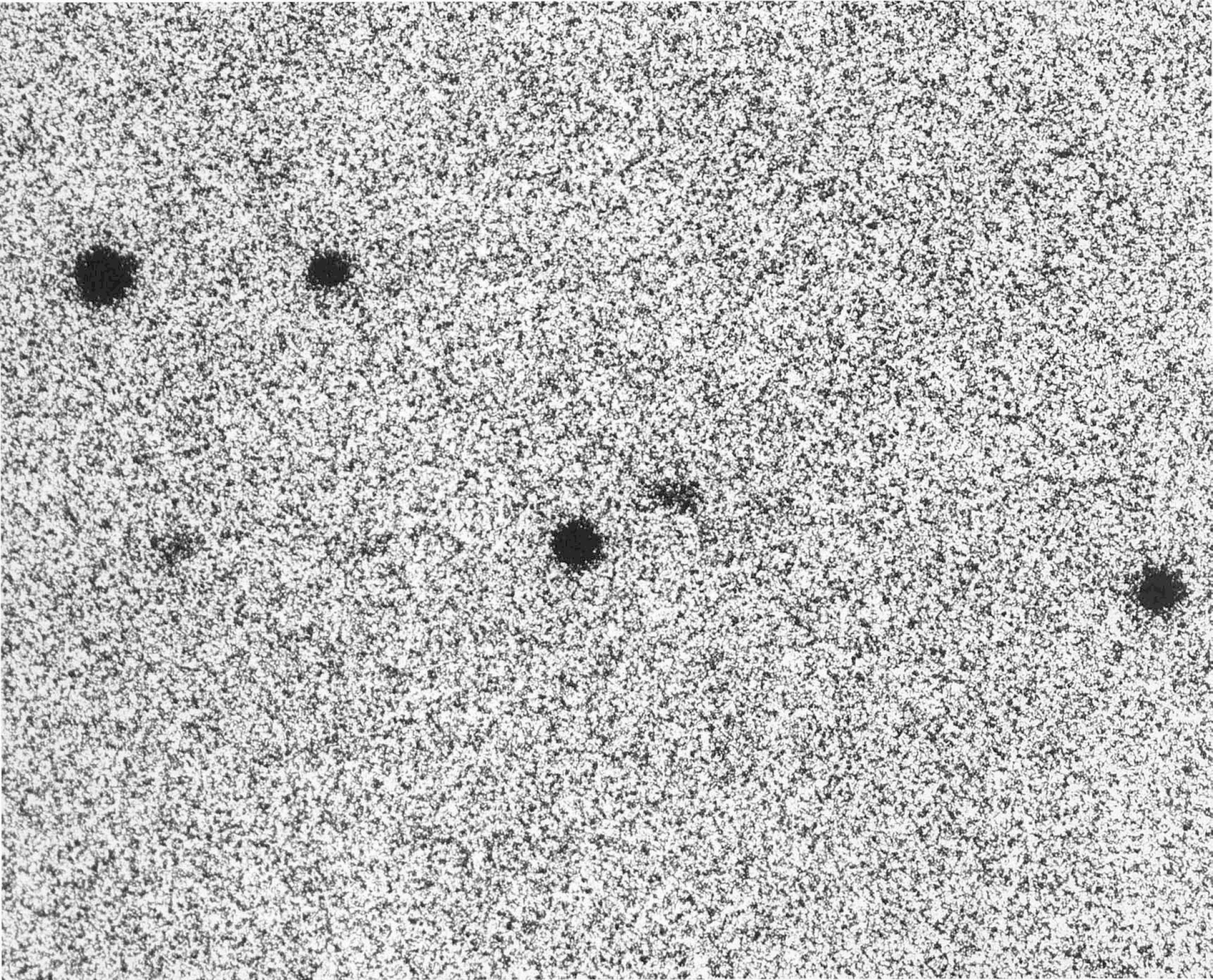

gate the properties of the minor planets and to learn more about their origin, we must know how many there are and in which orbits they move. When we know the orbit of a minor planet, we can investigate the object using other methods, and determine its size and surface composition. In this way, we can also pick out the unusual ones, and study them in more detail. As is the case for other objects in the Universe, we learn much from “pathological” planets. It is an open question whether we shall ever mine precious metals from the surface of selected minor planets, but the captains of future spaceships will undoubtedly appreciate our accurate charts of the dangerous passage through the minor planets’ main belt.

189 Some minor planets are influenced by the giant planet Jupiter’s enormous gravitational field and now move in orbits that are governed by the Sun and by Jupiter. Such planets typically move near Jupiter’s orbit, about 60° ahead of or behind Jupiter, and they always stay relatively close to the Ecliptic. The minor planet that is seen as a star-like spot, at the very centre of this picture, is an exception to this. It was found at ESO in 1976 and its mean distance from the Sun is about 750 million km, similar to that of Jupiter. However, its orbit is inclined at almost 40 degrees to the Ecliptic, so that sometimes it is far above, and sometimes it is far below this plane. At one point in its orbit it is almost 500 million km above the plane, higher than all other known minor planets but one. Quite appropriately, it carries the name “Stentor”, after the famous Greek warrior in the Illiad, whose voice was louder than 50 men together. It has long been a tradition to name minor planets near Jupiter’s orbit after the warriors of the Trojan war. The diameter of (2146) Stentor is probably about 15 km.





3.2 Comets

In ancient times, before the advent of telescopes and sophisticated astronomical measuring instruments, it was believed that the sky was forever the same. True, the five major planets known in those days followed their own paths, but the stars always remained in the same place. They were firmly fixed in the sky and were considered to be an expression of divine eternity, as opposed to the short and violent human life on Earth. The supernatural realm of the sky was only disturbed once in a while when a “guest star” appeared. It is easy for us to comprehend that such an event was always interpreted as a sign from the gods. Three types of “guest stars” can be recognized in historical sources: ordinary novae, supernovae and comets. Novae are less powerful stellar explosions than supernovae and quite a few of these events are known from very early sources, in particular from China and other countries in the Far East. There are fewer supernovae in historical sources; the best known is the one in Taurus that gave birth to the Crab Nebula in 1054. Plenty of comets have been observed during the past 3000 years, but they can only be unambiguously identified as such if the sources contain an indication of motion in the sky.

Up to 1986, the appearance of more than 1000 comets in the skies have been recorded. The earliest observations that have survived to our days in the form of inscriptions, consist of little more than a mention of the sudden sighting of a “hairy star” in this or that constellation. More complete sets of observations are available from about 2000 years ago. Astronomers in those days were still uncertain about the physical nature of comets and some considered them as atmospheric phenomena. However, the Danish

astronomer Tycho Brahe (1546–1601) observed a number of bright comets towards the end of the 16th century. He found that they were at distances greater than that of the Moon, thereby definitely proving that comets belong to interplanetary space. The computation in the late 17th century of the orbits of several comets, including Comet Halley, showed that most of them move in very elongated (elliptical) orbits. These comets are periodic, they return at regular intervals, but others move in open (parabolic or hyperbolic) orbits and are only seen once.

The comets are the most “primitive” bodies known in the Solar System. The recent return of the famous Comet Halley has greatly increased interest in these elusive objects, and there is now little doubt that they contain some of the keys to our understanding of the processes in the early Solar System.

190 About 20–25 comets are sighted every year. Half of these are well-known objects that move in elliptical orbits and have periods of revolution around the Sun of 5–30 years. The others are new discoveries, made by amateur and professional astronomers. Most of the new ones have very elongated orbits with periods of many thousands or even millions of years. The majority of comets are rather faint; in a normal year, only one or two comets become bright enough to be seen with the naked eye. And only about once a decade does a really bright comet appear.

One of the brightest in this century was discovered at ESO in 1975 and became a very impressive sight in the sky in early 1976. It was first seen on a Schmidt plate, part of which is reproduced here. Like minor planets, comets move slowly across the sky, and during a photographic exposure, they also form short trails. These trails are similar to those of minor planets,

but as comets are diffuse objects, their trails are “softer”. It can be difficult to see the difference if the comet is very faint, and not all comets are immediately recognized as such when they are first seen on a photographic plate.

This particular comet was found as a small trail on this plate, which was obtained in September 1975 for the first ESO photographic atlas of the southern sky. The sky region is in the constellation of Microscopium and during the one-hour exposure, the comet moved about 1 mm on the plate. Can you find the short, diffuse trail? The position is given below (Plate 191).

Other trails of the same object were found on plates taken in August 1975 and the orbit of the comet was computed. It showed immediately that the comet would become a rather bright object in early March 1976, soon after it had passed its perihelion, that is the point in its orbit nearest the Sun. According to astronomical custom, the object was now named “Comet West” after the ESO astronomer who discovered it. As it moved closer and closer to the Sun, it became brighter and brighter and by early February 1976, it was visible with the naked eye in the southern sky.

191 The small trail of Comet West on the discovery plate, about 6 mm from the left border and 29 mm below the top of Plate 190, shows the comet when it was still at a distance of 470 million km from the Sun. It had already developed a cloud around its central body, *the nucleus*. From observations of comets during recent years, and in particular from the spacecraft encounters with Comet Halley in March 1986, we have learned that a cometary nucleus measures 10–15 km across. It consists of frozen material, mainly water and carbon dioxide ices, mixed with dust particles of all sizes. The nucleus is aptly termed a “very dirty snowball” and it is



covered by a very dark layer of carbon-rich material. When a comet is far from the Sun, its nucleus is inactive, but closer to the Sun, evaporation takes place from the surface as it is heated by the radiation from the Sun. The nucleus then shrouds itself in a cloud of gas and dust, called *the coma*. The dust particles are released and are then left behind along the comet's orbit. If the Earth crosses this orbit, many of the dust particles enter the atmosphere and are seen as meteors.

As Comet West moved closer to the Sun, its coma expanded. By the action of the solar wind (a stream of fast particles emitted in all directions by the Sun), gas and dust was pushed out from the coma and formed tails. On this photo, taken in early March 1976, the blue colour of the comparatively narrow gas tails and the red colour of the much wider dust tails are clearly seen. The length of the tail was more than 100 million km, that is $\frac{2}{3}$ of the distance between the Earth and the Sun. About this time observations showed that the nucleus had, all of a sudden, broken into four pieces and that the ensuing evaporation process had become much more vigorous than expected. Consequently, Comet West became several magnitudes brighter than predicted; when it was brightest, it rivalled the brightest planets and was several times more luminous than Sirius. Amateurs and professionals alike enjoyed the sight, and a large number of astrophysical studies were undertaken from the ground and from space. With the exception of Comet Halley, few comets have ever been studied so intensively.

The glory did not last long. A few months later, when the comet was rapidly moving away, it became too faint to be seen with the naked eye and towards the end of 1976 it could only be observed with large telescopes. We shall not see Comet West again because its orbital period has been determined as more than one million years.



192 Among the comets that have been discovered at ESO, two have short periods and return regularly to the inner regions of the Solar System. It is thought that all comets were originally far from the Sun and that they were formed at the outer borders of the Solar System, 4.6 bil-

lion years ago. Most of them now move in extremely elongated orbits that reach almost halfway to the nearest stars. Since the motion is slowest in the far part of the orbit, a comet spends virtually all its time at these very large distances, in the so-called Oort-cloud of comets,

named after the Dutch astronomer Jan Oort who first put forward this theory. This cometary cloud surrounds the Solar System at a distance of about 10000 billion km.

Short-period comets have had their original orbits dramatically changed by one or more passages near one of the large planets. This was most likely to have been the case for the comet that was discovered at ESO on September 5, 1977. It was found to move in an elliptical orbit with a period of only 7.5 years and was named "Comet Schuster" after the ESO astronomer who found it. It was a relatively faint object of 16th magnitude when this photograph was taken with a large telescope, but the coma and a short, stubby tail are clearly visible. Comet Schuster returned again in 1985–1986.

193 Almost all comets that have been observed in history have orbits that reach inside the orbit of Jupiter. It is therefore of particular interest when a comet is discovered that always remains outside this distance. Two such comets have been discovered at ESO. The comet with the most distant perihelion was found at ESO; it is also called Comet Schuster and it was discovered about a year after it went through perihelion. Its minimum distance from the Sun, at perihelion, is an incredible 1030 million km, nearly halfway between the orbits of Jupiter and Saturn. Still, this comet was seen with a 4 million km tail, indicating that evaporation from the nucleus took place, even at that great distance. As temperature decreases with distance from the Sun, this observation proved the existence of ices with a very low melting-point in the nucleus of this comet.

The farther away a comet stays from the Sun, the less its material is altered. If we want to observe "pure", very old material, we should therefore look for very distant comets. Unfortunately

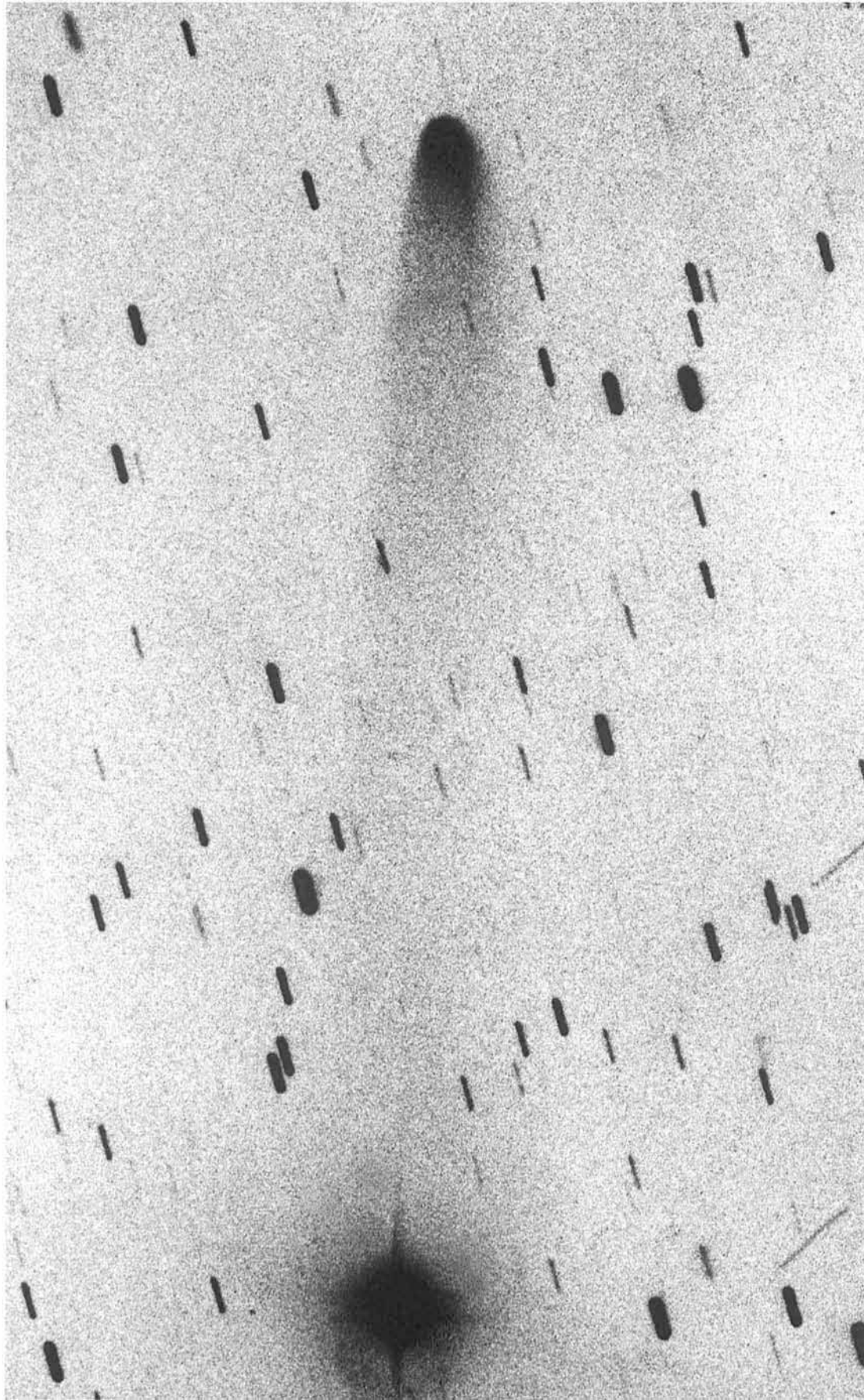

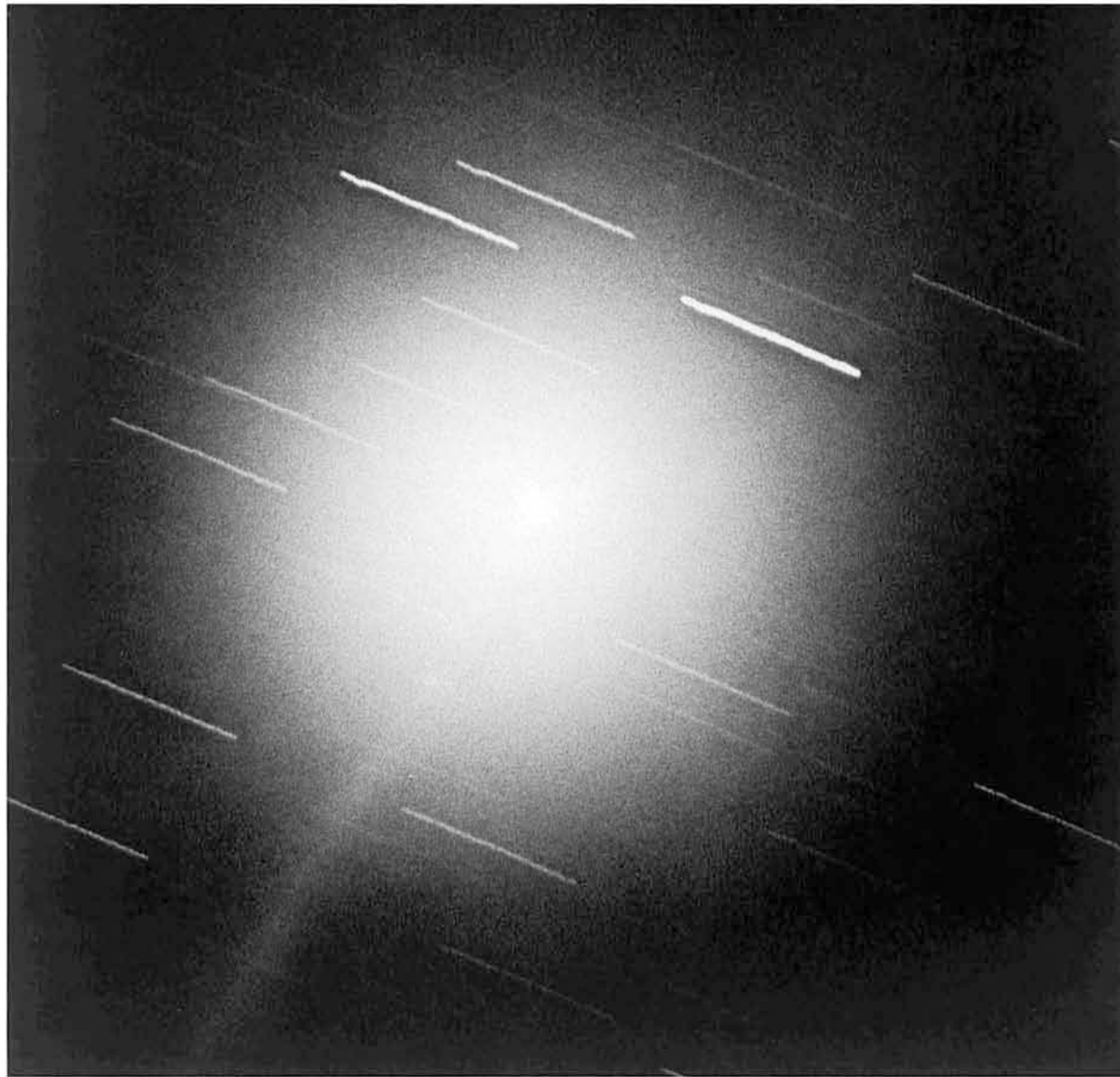

such objects are very faint, and it is difficult to study them with currently available techniques. This was the case with another comet that was found in early 1978 at ESO. It also has a very large perihelion distance, 840 million km, but it was still possible to obtain this picture with the 3.6-m telescope, when it was more than 900 million km from the Sun. To some surprise, it shows a well-developed dust tail, more than 2 million km long and there is even a hint of a gas tail

in the form of a short spike extending from the coma. However, a spectrum that was obtained at the same time only showed reflected sunlight from dust, so in any case the amount of gas in the coma must have been small. The stars are trailed, because the telescope followed the motion of the comet during the exposure.

Both of these ESO comets move in hyperbolic, open orbits and will therefore never return to the inner regions of the Solar System. They



move too rapidly to be retained by the gravitational pull of the Sun as they continue into interstellar space. It is also possible that they did not come from the Solar System, but that they were formed somewhere else and were interstellar visitors just passing by.

194 A comet was discovered by the Australian amateur astronomer William Bradfield in late 1979. During the second half of January 1980, it approached the Earth within 30 million km and presented itself for detailed study. This photo was obtained with the ESO 3.6-m telescope when the comet was moving fast across the sky, near the celestial South Pole. The star trails are very long, even on this short exposure.

The emulsion was blue-sensitive and the plate shows the gas in the coma. A very narrow gas tail emanates from the nucleus. It consists of molecules, mostly cyanide (CN) and carbon monoxide (CO), which have been ionized by the solar ultraviolet radiation.

195 This red-light photo of Comet Bradfield (1979 I) was taken at almost the same time as Plate 194, and shows the dust around the nucleus. Note how the dust is more concentrated towards the centre than the gas. The smallest details that can be recognized in the coma on these two photos are about 150 km across. The nucleus cannot be seen here since it is even smaller, probably less than 10 km in diameter.

196 In 1982, the "International Halley Watch" was created as a world-wide organization of astronomers who would work together on Comet Halley. By 1986, when this famous comet paid its long-awaited visit, more than 1000 professional, and several thousand amateur astronomers had become linked to the IHW.

The preparations for these observations took several years, and during this time other comets were observed in order to test the equipment and to try out the communication links that were essential for the success of the Halley research. One of the comets chosen as a "test" object was Comet Crommelin, which had earlier been observed in the years 1818, 1873, 1928 and 1956. In mid-March 1984, it was photographed with the ESO Schmidt telescope. It was a somewhat disappointing object, which never became brighter than 10th magnitude. This photo in red light shows the dusty coma. A satellite crossed the field during the exposure, which was guided on the comet; the stars are therefore seen as trails.

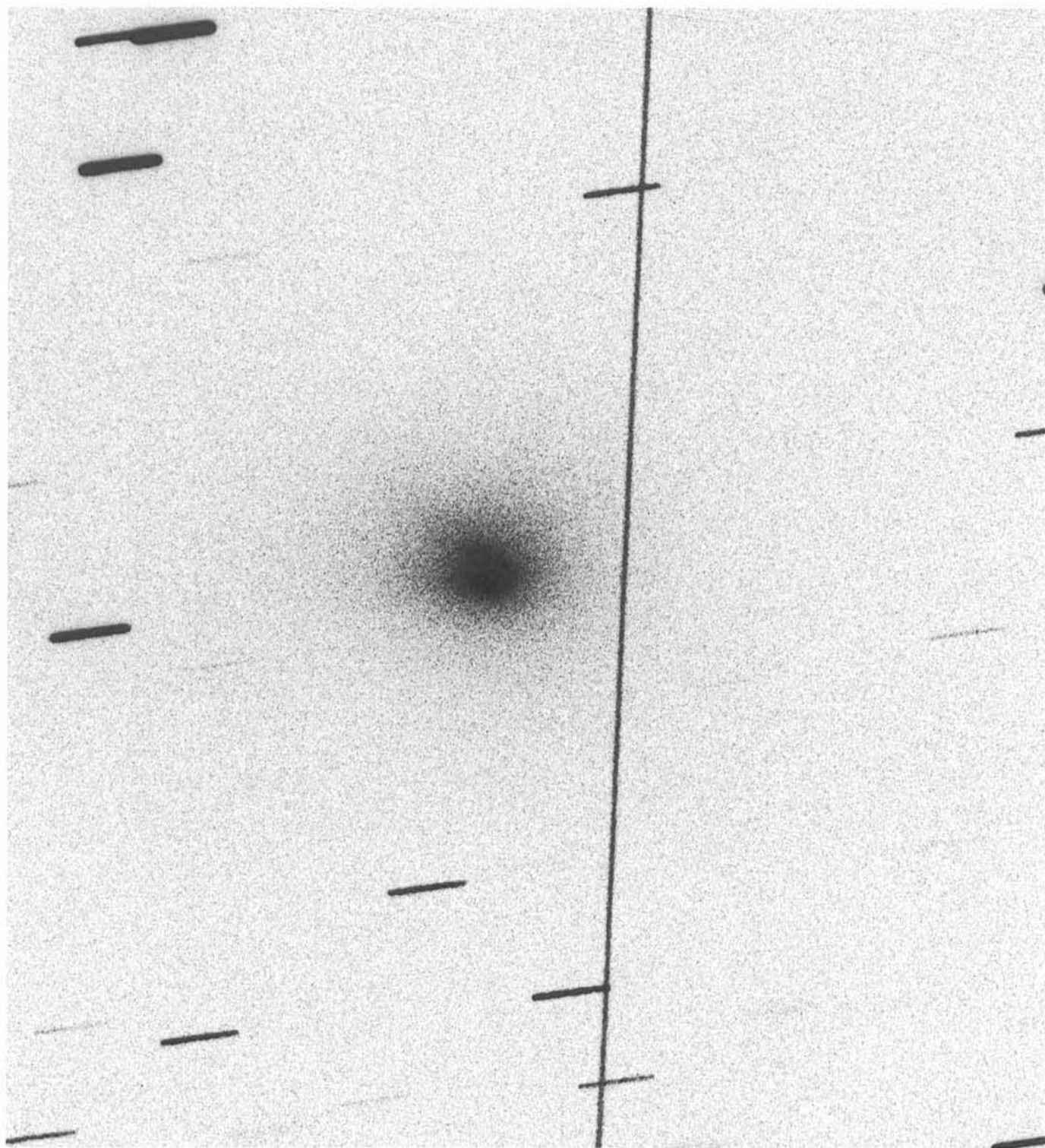

197 Comet Halley, the most famous of all comets, owes its name to an English astronomer, Edmond Halley. Soon after the passage of a bright comet in 1682, he used the theory of gravitation, newly developed by another English scientist, Isaac Newton, to compute its orbit in the Solar System. He was thereby able to prove that the 1682 comet was identical to the comets that had been observed in 1531 and 1607. Halley also predicted that the comet would return in 1758. The actual sighting in December 1758 of “Halley’s Comet” (as it was then called), was considered a triumph of astronomical computation and a confirmation of Newton’s theory.

We know from historical accounts that Comet Halley has been observed by people in ancient times. The first reliable observation of Halley that has been transmitted down to our time was made from China in the year 240 B.C., but there are indications that it had been observed even earlier. With a period of about 76 years, it has been seen 30 times since. In this century, it was widely observed in 1910–1911. The next perihelion passage was predicted to take place on February 9, 1986.

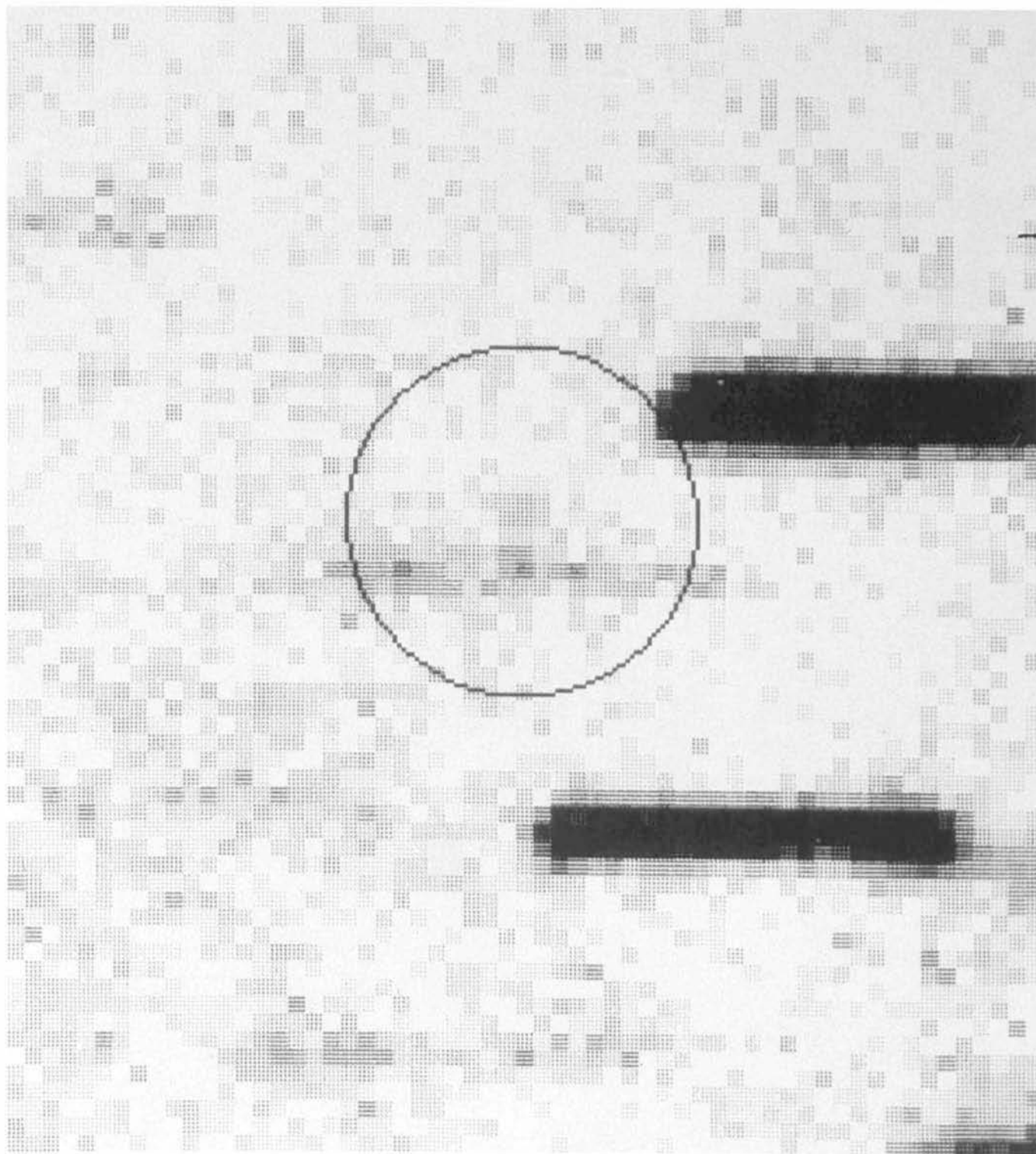

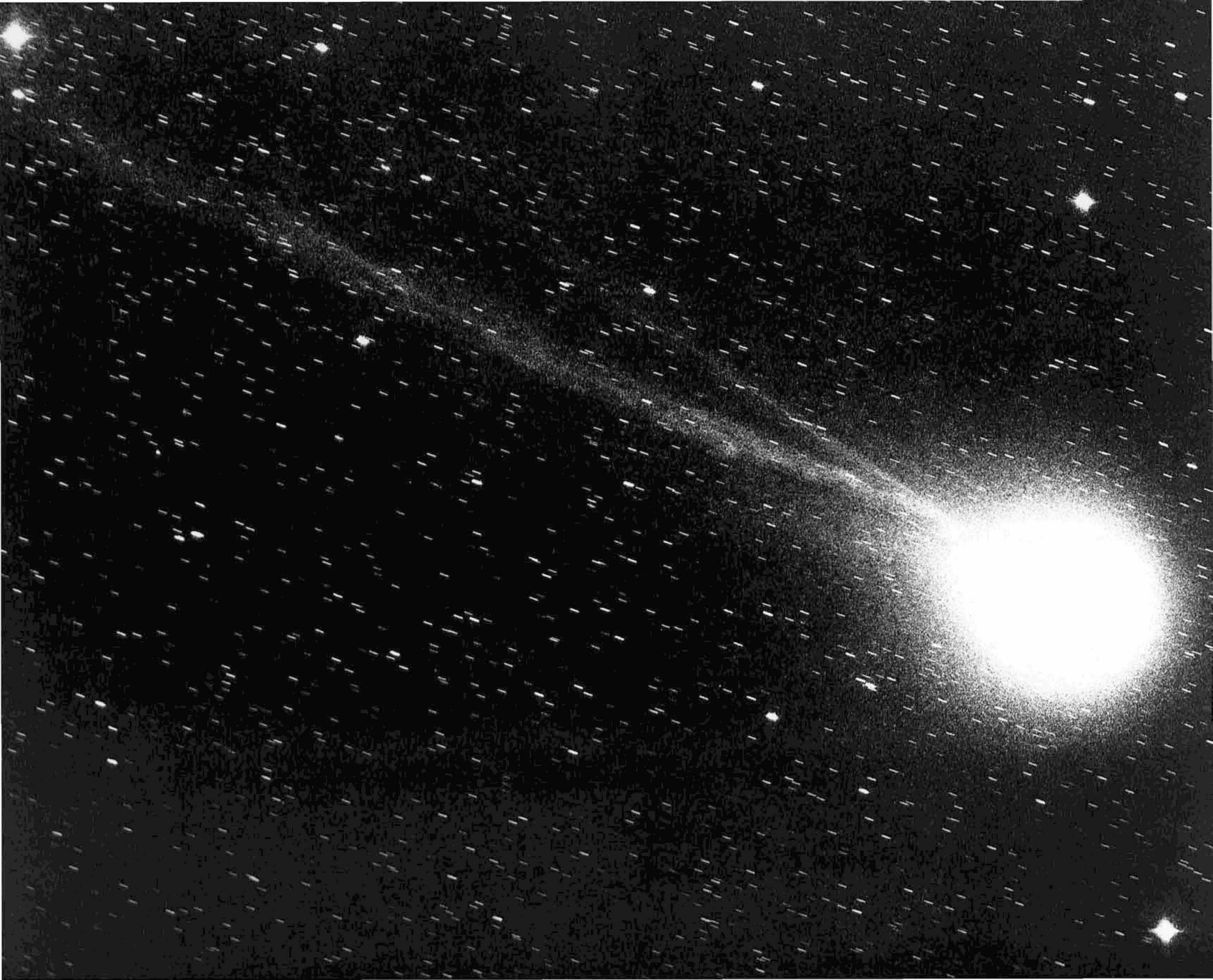

By the late 1970's astronomers started to look for Comet Halley, then returning towards the inner Solar System. After several unsuccessful attempts, it was finally recovered with the Palomar 5-m telescope on October 16, 1982, when it was still 1 650 million kilometres from the Sun, just beyond the orbit of the giant planet Saturn.

The first observation of Halley at the ESO La Silla Observatory was made less than two months later, on December 10, 1982, with the Danish 1.5-m telescope, equipped with a CCD detector. In this reproduction of the original CCD frame, it is at the centre of the circle. The stars are trailed, because the telescope was set to follow the expected motion of Comet Halley. The magnitude was measured as 24.5, that is Halley was 25 million times fainter than anything visible with the naked eye. The observation represents a remarkable feat with a telescope of this size. More CCD frames were obtained in early 1984 while the comet was still beyond the orbit of Jupiter, although its position in the northern sky made observations from La Silla, at geographical latitude -30° , rather difficult.

198 Spectroscopic observations and infrared photometry of Comet Halley began in 1985. As the comet became brighter, more and more northern observers joined in. Later, when it moved southwards, it became possible to use telescopes in the southern hemisphere. Although the public was repeatedly told that Comet Halley would not be a very bright object, many were clearly disappointed when the much-awaited, famous comet turned out to be little more than a faint, diffuse spot. As a matter of fact, Halley was unexpectedly slow in developing a tail and it was only in early December 1985 that a short extension to the coma could be seen. This blue-sensitive photographic exposure on December 9, 1985 shows two 3° – 4° long, narrow gas tails, emanating from the coma. Most of the light originates from cyanide molecules. Halley was then just inside the orbit of Mars and the distance to Earth was 108 million km.

199 In early 1986, Halley moved rapidly towards the Sun. By mid-January it was lost in the Sun's glare and could no longer be observed with optical telescopes on the ground. However, by then five spacecraft (*Giotto* from the European Space Agency, *Vega 1* and *Vega 2* from the USSR, and *Sakigake* and *Suisei* from Japan) were flying towards close encounters with Halley. The US spacecraft ICE was due to pass Halley at a greater distance. The scientists controlling the spacecraft urgently needed navigational data, in particular information which would allow them to calculate the accurate orbit of Halley. To support this, a special effort was made at ESO to acquire astrometric (positional) data for Halley as soon as possible after perihelion passage on February 9. As a result, the comet was recovered at ESO as early as February 15, when it was only 15° from the Sun. Owing to the excellent observing conditions at La Silla, from then on, highly accurate positions could be transmitted daily to the space centres, together with detailed information about other cometary phenomena such as outbursts from the nucleus, tail structure, etc. These data represented an important contribution to the very successful encounters in the period from March 6–14.

On February 22, when it became possible to make longer exposures, this wide-field CCD picture was obtained of Halley with at least seven tails. The false colours make it easier to see faint details. The white area in Halley and the vertical lines near two bright stars in the upper half of the picture are due to over-exposure. Two gas tails point towards the west. The length of the longest is about 6° , or 22 million kilometres. The other tails, which form a wide fan towards the north are rather red and consist mainly of dust that reflects sunlight. This dust was released from the nucleus some days earlier. The dust tails are like tree-rings, each corresponding to



a particular outburst. By measuring their shape and direction, it was possible to reconstruct the sequence of outbursts that took place near perihelion. Note that on Plates 199 and 200 North is to the left.

200 On February 27, just after full Moon, when it was difficult to see Comet Halley in the bright sky, this false-colour picture was obtained by means of a wide-field CCD camera with a special optical filter. It shows the distribution of carbon monoxide gas in the comet's tail. It is likely that these molecules originate from carbon dioxide, which is present as dry ice in the nucleus. Near the comet's head several "streamers" are visible; they are jets of gas that have been ejected from the coma. The tail widens farther out and becomes less dense as the gas disperses into interplanetary space. On this date, the comet was at a distance of 196 million kilometres from the Earth, and 105 million kilometres from the Sun.



201 This colour photo of Comet Halley on March 1, 1986 was obtained by combining three black-and-white photographs. Since the comet moved during the exposures, the stars are seen as small, differently coloured trails. The length of the tail seen in this picture is about 1 degree, or 3.3 million km.

Just before this picture was taken, the nucleus experienced a major outburst. Such outbursts, during which the region immediately around the cometary nucleus brightens considerably in the course of a few hours only, have been observed in several comets before, but a detailed understanding was lacking. We now know from the Vega and Giotto pictures of Halley's nucleus that it is avocado-shaped and measures around $8 \times 8 \times 16$ kilometres. The gas and dust which escapes from the surface of the nucleus does not evaporate uniformly from the entire surface area. The activity is limited to a small number of vents, which become active when illuminated by the sunlight. Since the comet rotates as do all other bodies in the solar system, each vent alternatively experiences "night" and "day". It seems that the vents are particularly active during the "morning", that is, when they become illuminated after having been in the dark during the cometary "night".

The surface of Halley's nucleus is covered by a very dark layer, probably made up of organic molecules. We do not know how deep it is, but it is likely that there are many cavities below it. When the heat from the Sun evaporates the material above such a cavity and opens it to near vacuum of space, a sudden release of gas and dust takes place in the form of an outburst. The time interval between recurring outbursts have allowed a determination of the rotation period of Halley's nucleus; it is about 52 hours. (It also rotates around a second axis with a period of more than 7 days.) It is remarkable that such a small body rotates more than twice as slowly as the much larger Earth.

This photo was taken within a long-term photographic programme with the ESO GPO and Schmidt telescopes, which lasted from mid-February to mid-April 1986. During this period of uninterrupted clear skies over La Silla, the behaviour of Comet Halley was documented in detail. Together with photos which were obtained at other observatories, we now have a continuous record of events, from minor changes in the dust and gas structures near the nucleus, to the dramatic large-scale events in the tail system (see the next Plates).

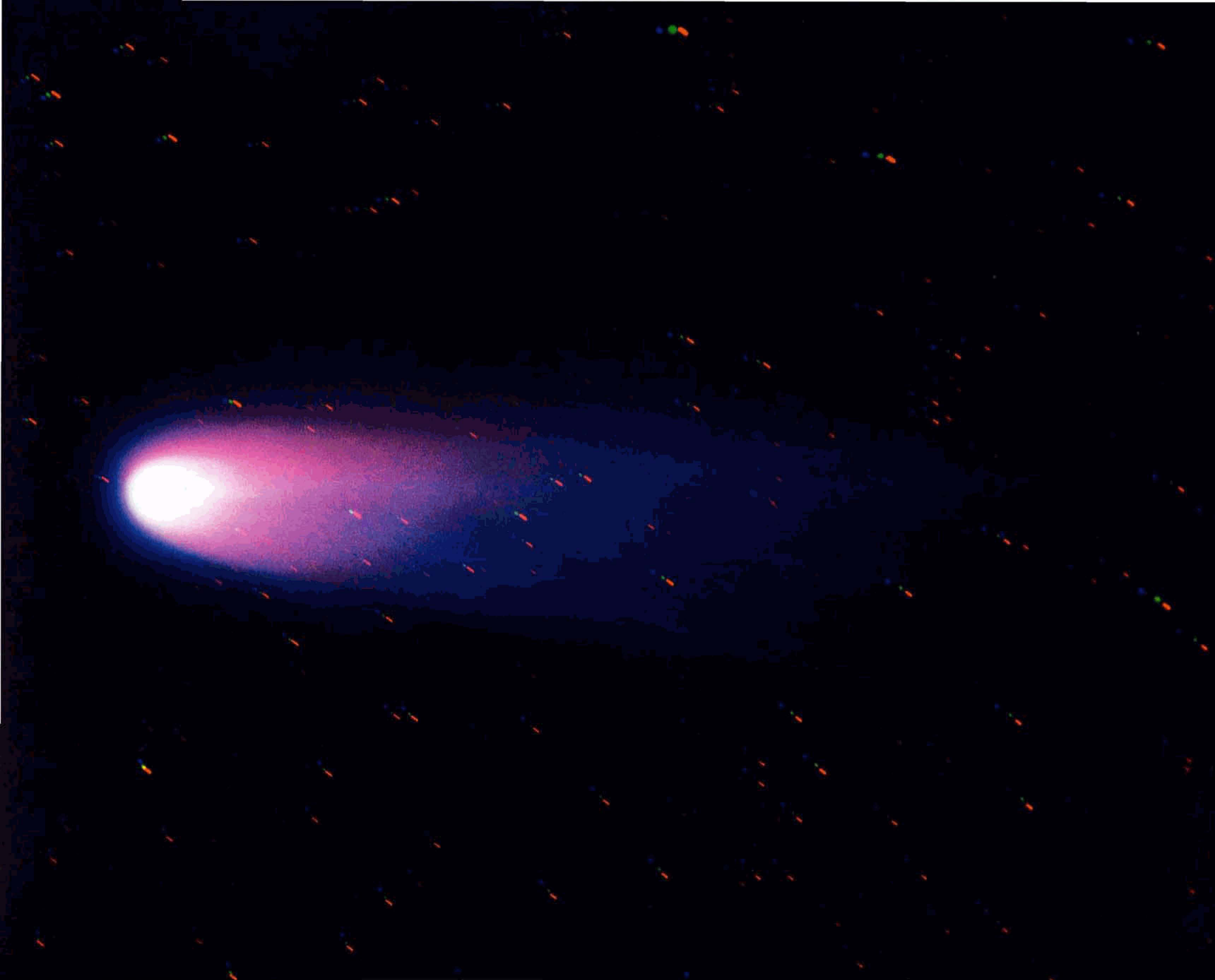

202–203 The observations of Comet Halley at ESO continued during the spacecraft encounters in early March 1986. Dramatic changes were observed in the gas tails between March 8 (Plate 202) and March 10 (Plate 203). On the first date, the main gas tail has a wiggly structure and there are many narrow streamers on the south side. At least seven broad, diffuse dust tails are also visible on the opposite side. The next day, the gas tail has become more disordered and on March 10, a part of the gas tail has become entirely detached. This phenomenon, which is also known as an “elephant-trunk-type disconnection event”, was also observed on January 10, 1986. It is due to a rapid change in the direction and velocity of the solar wind. This in turn causes a change in the interplanetary cally charged gas tail. Note that on these Plates North is to the left.

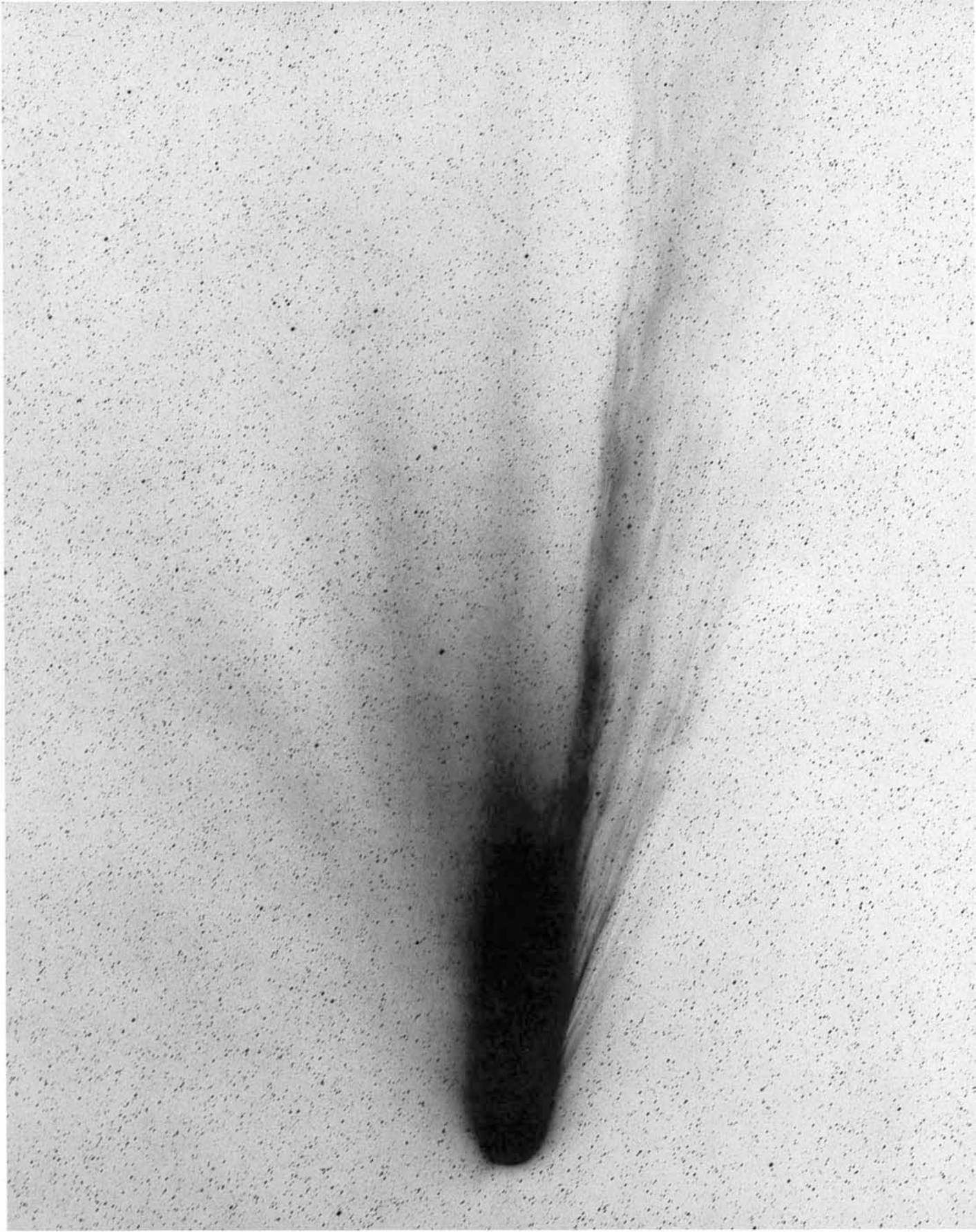

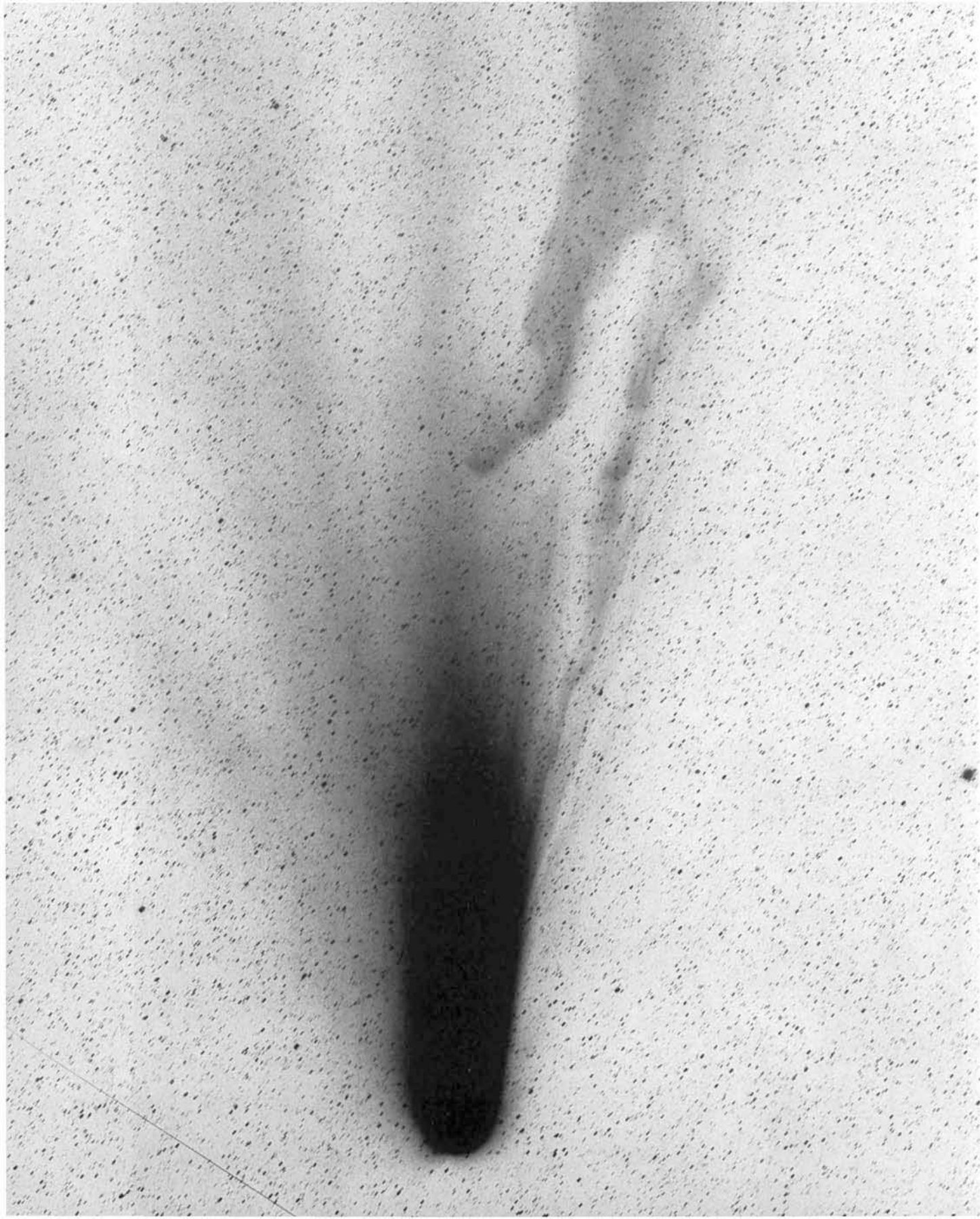

204 All through the month of March 1986, Comet Halley moved southward in the sky. In the morning of April 3, when it was crossing the border between the constellations of Corona Australis and Scorpius, it rose above the dome of the ESO 3.6-m telescope. This dome stands 45 m tall and measures 30 m across. As in Plate 178, the faint parts of the tail merge with the star clouds of the Milky Way. The bright stars above the dome are ι^1 and κ Scorpii.

As Comet Halley continued outward along its elliptical orbit, it rapidly became fainter and fainter. By mid-July 1986 the magnitude was 10, and as it was moving behind the Sun, as seen from the Earth, it could no longer be observed. In late 1986, it reappeared as a very faint object in the southernmost part of the constellation of Leo. Observations continued with the largest telescopes. It will be followed for several years and when the new generation of very large telescopes enters operation in the 1990's it may even become possible to observe Comet Halley when it is at aphelion between the most distant planets in the Solar System, Neptune and Pluto. And when this famous comet returns in the year 2061, we shall know much more about this class of objects, and also about the formation of the Solar System, than we do now.



4 The Southern Sky and ESO



4.1 A European Organization for Astronomy

To the founding fathers of ESO, the presence in the southern sky of many beautiful and exciting objects, such as those presented in this book, provided ample evidence of the need for the establishment of a major observatory in the southern hemisphere. For instance, the centre of our Galaxy and the nearest galaxies, the Magellanic Clouds, are situated in the southern sky, and together with several other southern objects, they are of crucial importance in astrophysical research. Before the Second World War, most astronomical observatories were established near the centres of education in Europe and North America. By the early 1950's the southern sky therefore remained largely unexplored. However, at that time a wealth of astronomical discoveries in the northern sky were made with large telescopes at the mountain observatories in California, and thoughts about the possible installation of similar facilities in the south emerged in several countries. In view of the complexity and the cost, the erection of a major southern observatory with the best instruments in a distant place obviously called for collaboration between several nations.

The idea of creating a European Southern Observatory was originally put forward in 1953 by Jan Oort and Walter Baade, and during the following years the ground was prepared for the new organization. An important part of this initial work was a careful site investigation to find the location that would offer the best observational possibilities. This activity was originally concentrated around some sites in South Africa, and a 40-cm double astrograph (GPO) was installed at the Zeekoegat station in the Great Karoo desert. Similar investigations were carried out at the same time in South America, mainly by U.S. astronomers. They soon revealed that the southern part of the Atacama desert in Chile offered excellent conditions for astronomical observations.

4.2 The La Silla Observatory

On October 5, 1962, the European Southern Observatory (ESO) formally came into being with the signing in Paris of a convention between the governments of Belgium, the Federal Republic of Germany, France, the Netherlands, and Sweden. The convention called for the construction, installation and operation of a 3-m telescope, a Schmidt telescope, and up to four smaller telescopes, as well as the necessary auxiliary equipment, buildings, service facilities, etc. Thus, the combination of a large telescope and a Schmidt telescope with survey capabilities, which had turned out to be extremely successful at Mount Palomar, was to form the backbone of the future ESO observatory as well.

By 1963, a site was selected by ESO at 29°15' S, 70°44' W, on a 2400-m high mountain ridge, officially known as Cerro Chincado, but colloquially called La Silla (the saddle) due to its particular shape. Here, some 600 km north of Santiago de Chile and 70 km from the coast (Fig. 29), nature has created a remarkably clear, dry and stable climate. To the north is the arid Atacama desert, to the east the massive Andes mountain-range, and to the west the Pacific Ocean with its cold Humboldt current along the coast. The average rainfall at La Silla is only 50 mm/year and the temperature changes during the night are normally less than 3° C. There is relatively little turbulence in the air, so the "seeing" conditions are excellent, and the sky is clear for 6 consecutive hours or more on 70% of all nights. La Silla has long established itself as one of the finest sites for observational astronomy on this planet.

205 Stars rising behind the La Silla observatory.



206 The area around La Silla is very sparsely populated and there are no nearby major towns or industrial activities. The nearest towns are the twin cities of Coquimbo and La Serena on the Pacific coast, 160 km away, and there is easy access to the area by a secondary road from the Panamericana highway which runs at a distance of some 17 km from the entry point to the ESO Pelicano Camp, seen here. ESO acquired 625 sq. km of land around the La Silla site (later to

be extended to 800 sq. km) in order to safeguard the observatory against dust and light pollution generated by settlements or by mining activities. This precaution has proved very useful and it effectively preserves the quality of the La Silla site, whereas the sky illumination by street-lights in nearby towns has become a great problem to many observatories in other parts of the world.



Fig. 29 Plate 206

207–208 Design work began in the mid-1960's at the ESO offices, which were initially located in Hamburg. This work was continued by the ESO Telescope Project Division, which was created in 1970 and was housed on the premises of CERN (Centre Européen pour des Recherches Nucléaires) in Geneva. The first ESO telescope to be commissioned (in 1968) was the 1-m photometric telescope, followed by a 1.5-m spectroscopic telescope, which was an improved version of a similar instrument at Observatoire de Haute-Provence in France. The GPO double astrograph was transferred from South Africa to La Silla, and a 50-cm photometric telescope was built for ESO by the Copenhagen University Observatory, soon after Denmark joined ESO as the sixth member country in 1967. In 1972, the Schmidt telescope was put into operation, and in 1976, ESO's largest instrument, the 3.6-m telescope saw "first light". More telescopes have been installed since then, and these Plates show the transformation of La Silla into one of the world's largest astronomical observatories. The first picture was made in 1965, the second exactly 20 years later.



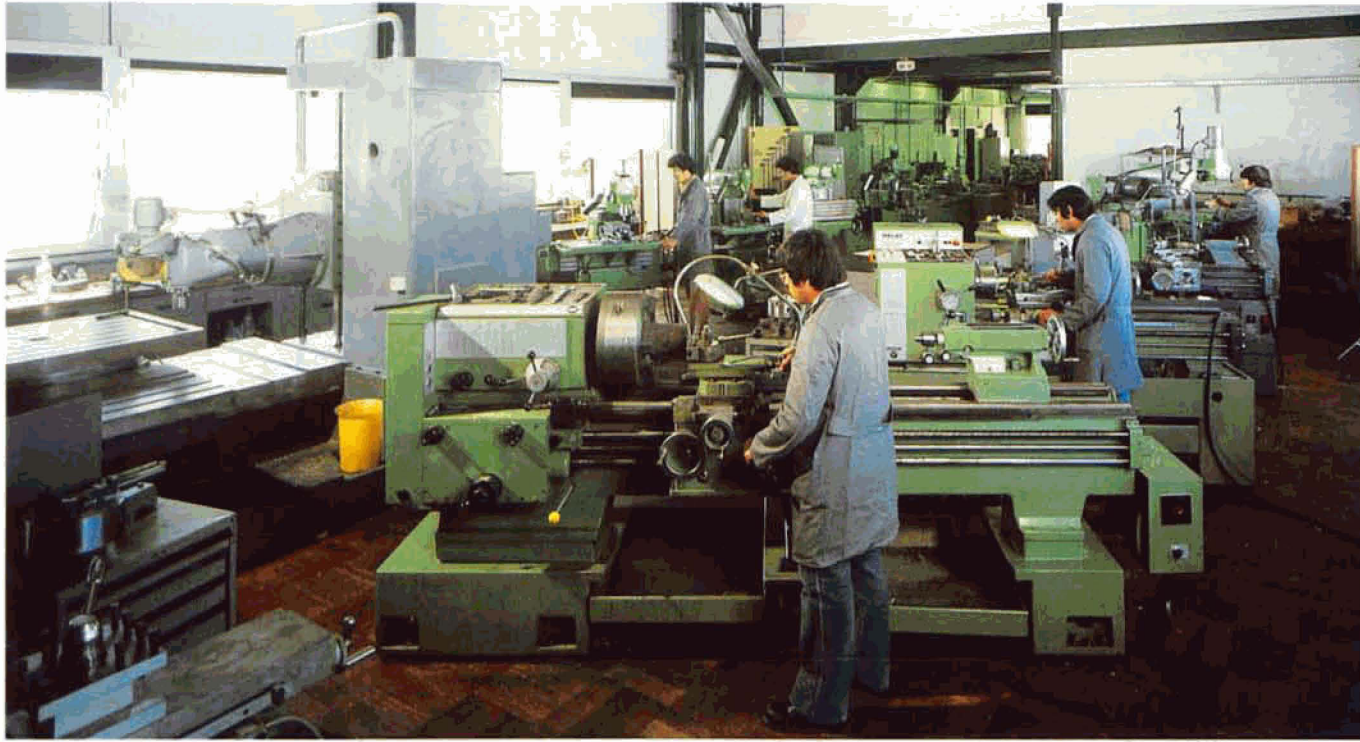

209–212 To construct and operate a major observatory in such a remote area poses major logistics problems. Thus a large number of service facilities has to be available on La Silla. They range from storage buildings containing almost everything needed for daily life in the desert, to workshops of all kinds (Plate 209). There is a hotel (Plate 210) with a small garden (Plate 211) and dormitories for visiting astronomers and technicians. An airstrip (Plate 212) has been built for the aircraft that operates between the observatory and Santiago de Chile, and there is a health centre as well as recreational facilities for staff when off duty. The operation of the observatory would be impossible without an experienced and dedicated staff. Daily – and nightly – duties on La Silla range from repairs of complicated electronic equipment, to the preparation of nourishing and tasty meals at odd hours of the day. The observatory must function smoothly 24 hours a day, 7 days a week.







213 The growing importance of ESO is reflected by the fact that three more countries have joined the organization since 1962. As mentioned earlier, Denmark joined in 1967, and Italy and Switzerland became members in 1982. Other European countries have expressed interest in closer collaboration with ESO. Over the years, many new activities have been added and the ESO La Silla observatory has now developed into a small town. This aerial view was obtained in February 1987.

1. 3.6-m Telescope
2. 1.4-m CAT
3. 2.2-m Telescope
4. 1.5-m ESO Telescope
5. 1.5-m Danish Telescope
6. 1-m Schmidt Telescope
7. 1-m ESO Telescope
8. 0.9-m Dutch Telescope
9. 0.7-m Swiss Telescope
10. 0.6-m Bochum Telescope
11. 0.5-m Danish Telescope
12. 0.5-m ESO Telescope
13. 0.4-m GPO
14. 15-m SEST
15. Hotel
16. Administration Building

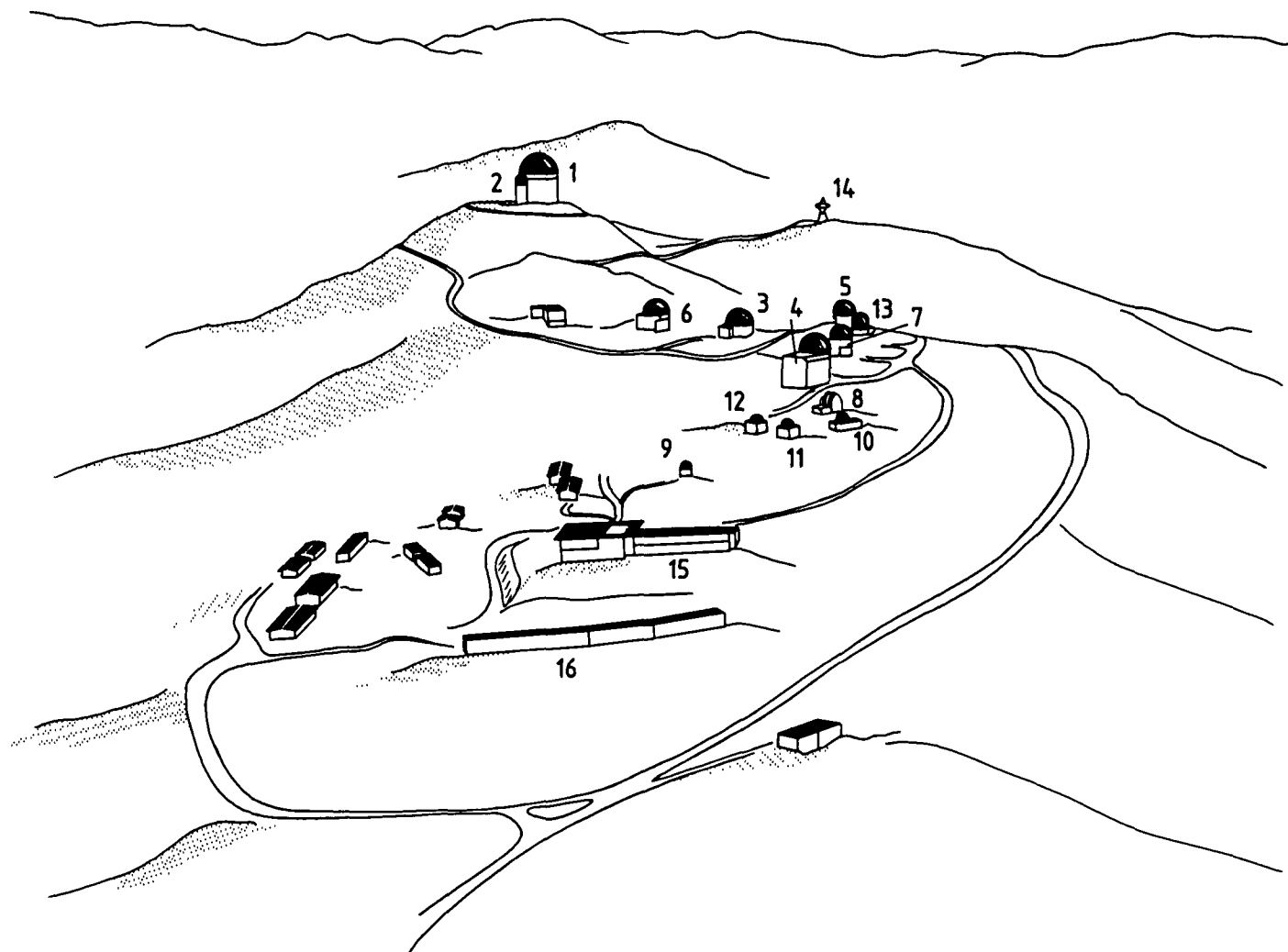



214–215 The impressive dome of the 3.6-m telescope, here seen shortly after sunset, houses one of the largest reflectors in the world. The primary mirror weighs 11 tons and is made of fused silica. It was cast by the Corning Glass Works in the U.S.A. and the painstaking figuring was done by *R.E.O.S.C.* in France. The telescope is of the type known as a Ritchey-Chrétien and rests in a fork mount. The dome has a diameter of 30 m and a height of 45 m.



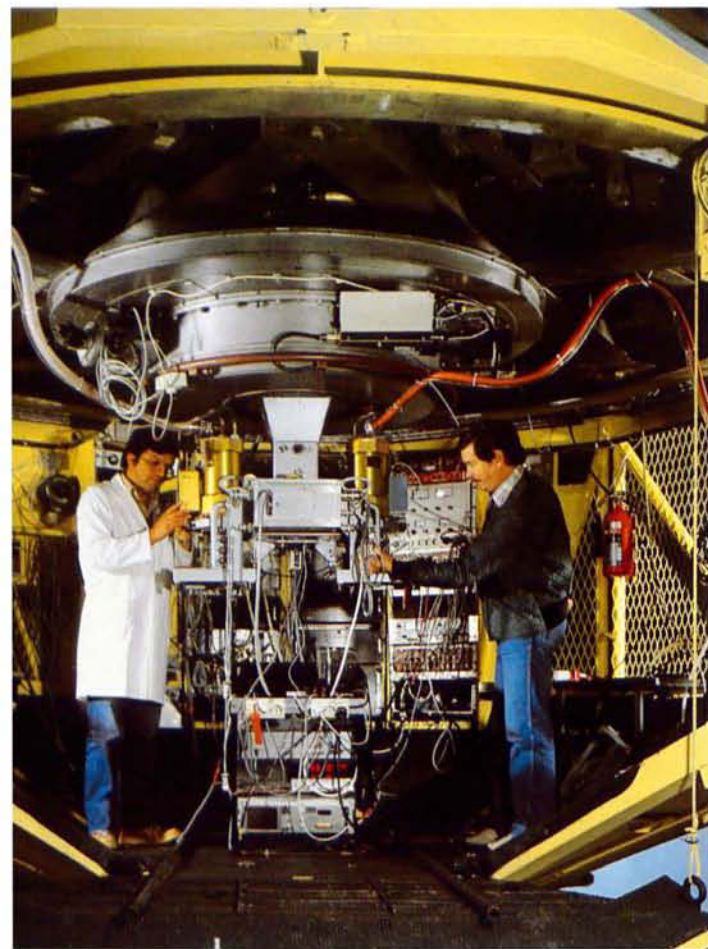

216–217 Optimum utilization of the ESO 3.6-m telescope was ensured by designing it as a multi-purpose instrument. This entails the use of an impressive range of auxiliary instrumentation such as spectrographs, photometers, etc. For this reason, the telescope has three foci: Above the primary mirror, there is a *prime focus* ($f/3$), which is used for direct imaging. There is a *Cassegrain focus* ($f/8$) behind the primary mirror, and this is shown in Plate 216 with an infrared photometer. Finally, a *coudé focus* ($f/30$) is situated below

the observation floor. It is used for bulky instrumentation which cannot be carried by the telescope itself (Plate 217). As the most powerful instrument on La Silla, the 3.6-m telescope is used to observe faint and distant objects. An enormous variety of astronomical research programmes are carried out with it, including studies of the atmospheres of the planets in the Solar System, of the structure of Milky Way nebulae, and of the most distant quasars and galaxies in the Universe.



218 Once every few years, the primary mirror of the 3.6-m telescope is stripped of its aluminium coating and then re-aluminized. During the operation, it is removed from the telescope and placed in a vacuum chamber in which the mirror surface is coated with a new layer of aluminium. In the photo we see the perfectly reflecting mirror after this delicate operation.

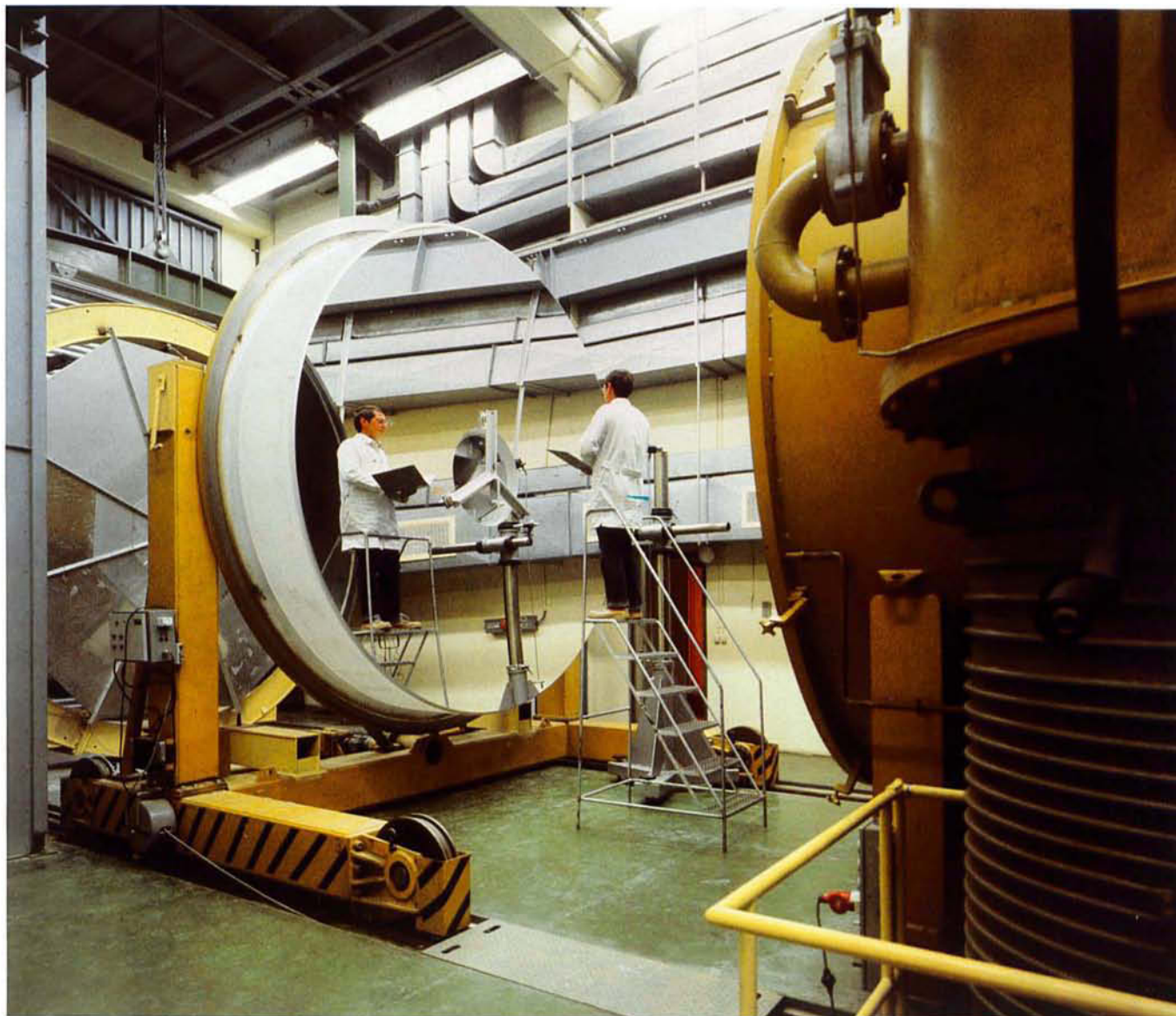



219–220 The 1.4-m Coudé Auxiliary Telescope (CAT) is placed in a separate dome next to the 3.6-m dome, to which it is connected by an 11 m long light-tunnel. The main purpose of the $f/32$ CAT is to feed the 3.6-m coudé instrumentation. In this way, observations can be made with the coudé spectrometer when the 3.6-m telescope itself is engaged in other work. The CAT rests in an “*alt-alt*” mounting and is driven by direct drive motors without gears.

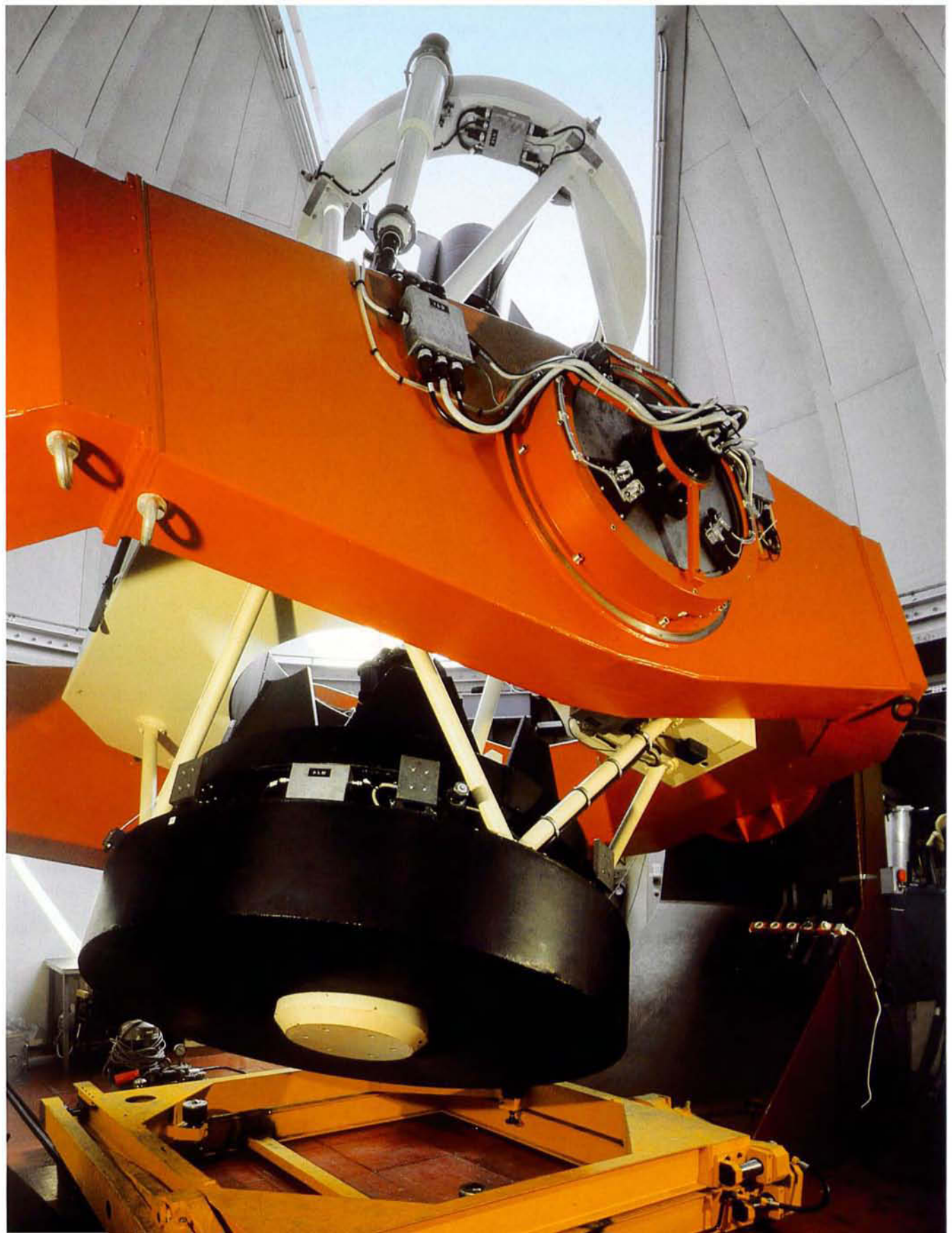



221 Like other telescopes, the CAT is run from a separate control room. The days, or rather nights, when observers had to look through the telescope's guider are gone. The CAT serves mainly to observe brighter objects at very high spectral dispersion, and studies of the chemical composition of individual stars and nebulae are made with this telescope.

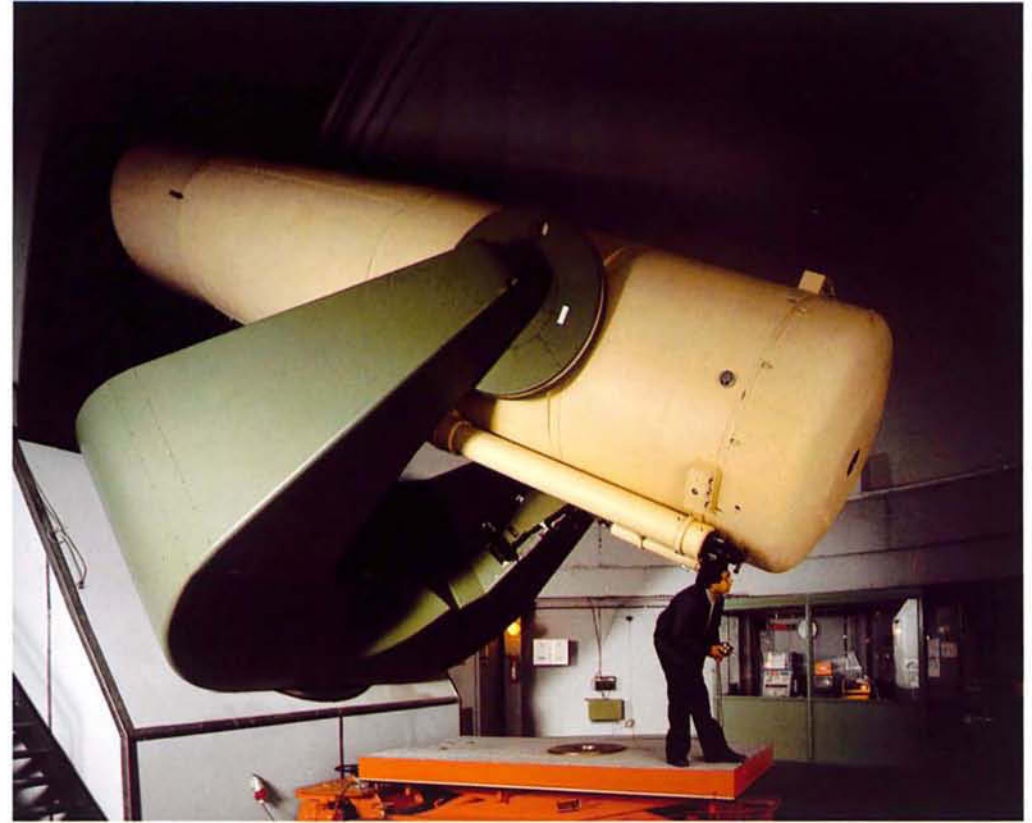

222 The ESO Schmidt, which was commissioned in 1972, is the second-largest instrument of this type in the southern hemisphere. Its 1.62-m primary mirror is made of Schott Duran glass and the aperture of the telescope is 1 m. It is a photographic telescope, which is able to record faint objects over relatively wide fields of the sky on a large photographic plate. It is therefore particularly suited for survey work. The ESO Schmidt was designed in such a way that the image-scale matches that of the Palomar Schmidt, which was used for the famous Palomar Sky Survey of the northern sky in the 1950's. It was therefore possible to undertake a complementary survey of the southern sky

with the ESO Schmidt. This work, which lasted from 1972–1978, led to the discovery of more than 12000 galaxies, many new nebulae and clusters of stars in the southern Milky Way, and quite a few minor planets and comets.

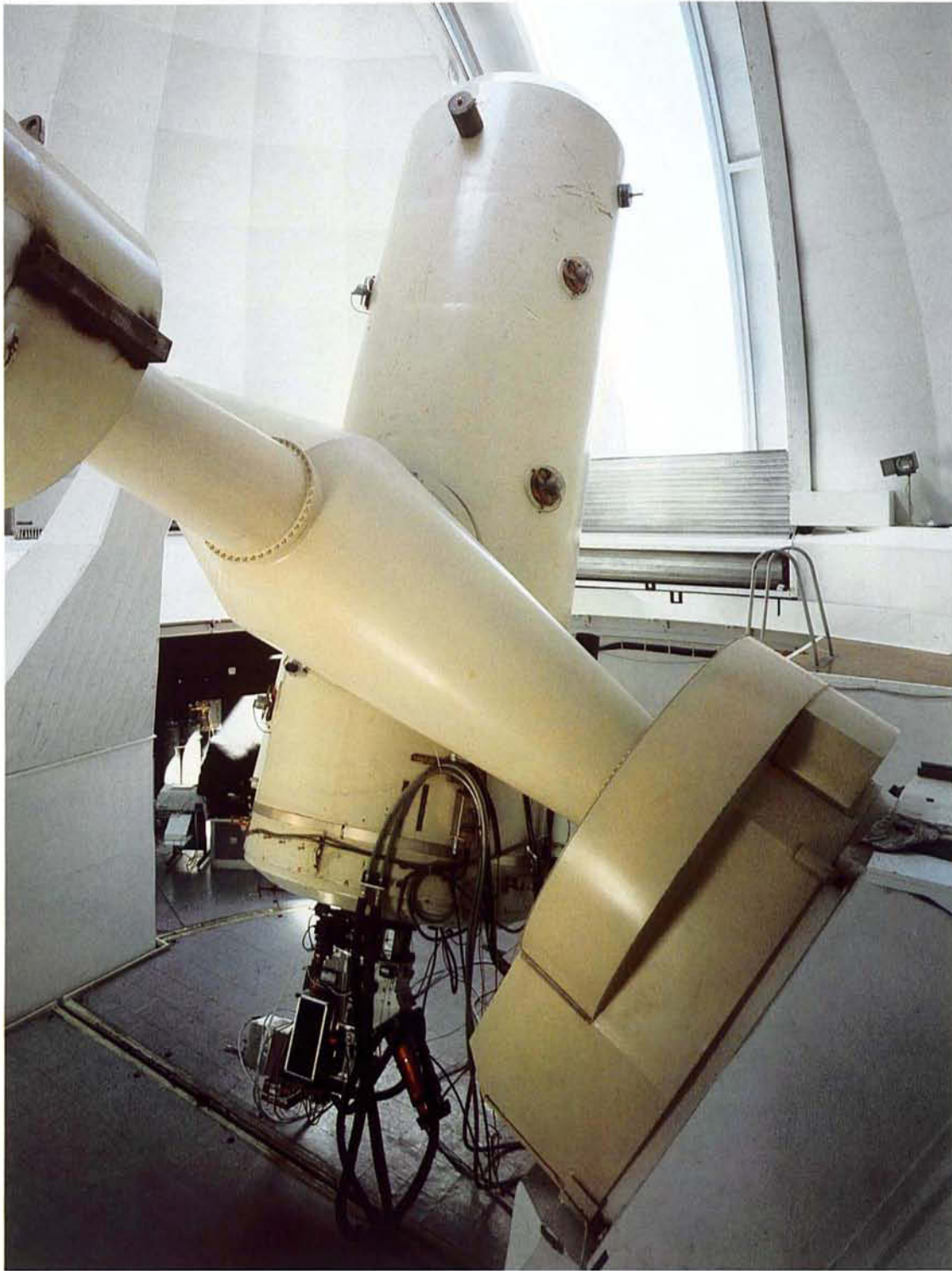
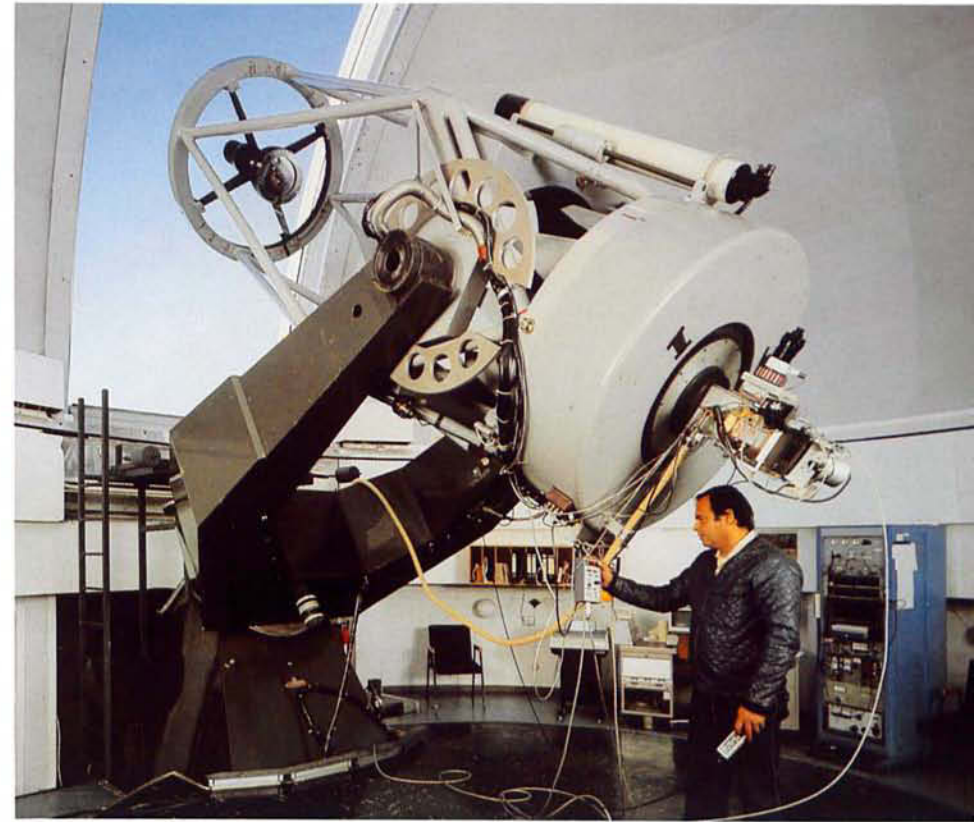

Plate 223



223–224 Two important instruments on the mountain are the 1.5-m spectroscopic (Plate 223) and the 1-m photometric telescope (Plate 224). As the names indicate, they are mainly used for spectroscopy and photometry of stars and galaxies.

Plate 224



225 Since being commissioned at the end of 1983, the 2.2-m telescope has enjoyed the status of the second-largest optical telescope in use at La Silla. It has been donated on long-term loan by the Max Planck Society in the Federal Republic of Germany. The equatorially mounted telescope was manufactured by M.A.N. and Carl Zeiss. It has taken some pressure off the 3.6-m telescope and is used for similar astronomical programmes.

THE NATIONAL TELESCOPES

Over the years several so-called “national telescopes” have been erected at La Silla. For each of these instruments, agreements between the owners and ESO were concluded which stipulate how the available observing time shall be divided between ESO and the national institutes. By early 1987, 14 telescopes were in operation at La Silla, eight of which belonged to ESO and six were national telescopes.

226 The 1.5-m Danish telescope, which has been in operation at La Silla since 1979, is owned by the Copenhagen University Observatory. Its main mirror is made of Cervit glass-ceramic and the optical system is a classical Ritchey-Chrétien configuration. The telescope has a Cassegrain focus only, at which a variety of auxiliary instruments and detectors can be placed. The Danish telescope was the first on the mountain to be equipped with a CCD detector. It is also used with CORAVEL, a complex instrument with which radial velocities of even faint stars can be accurately and efficiently determined.

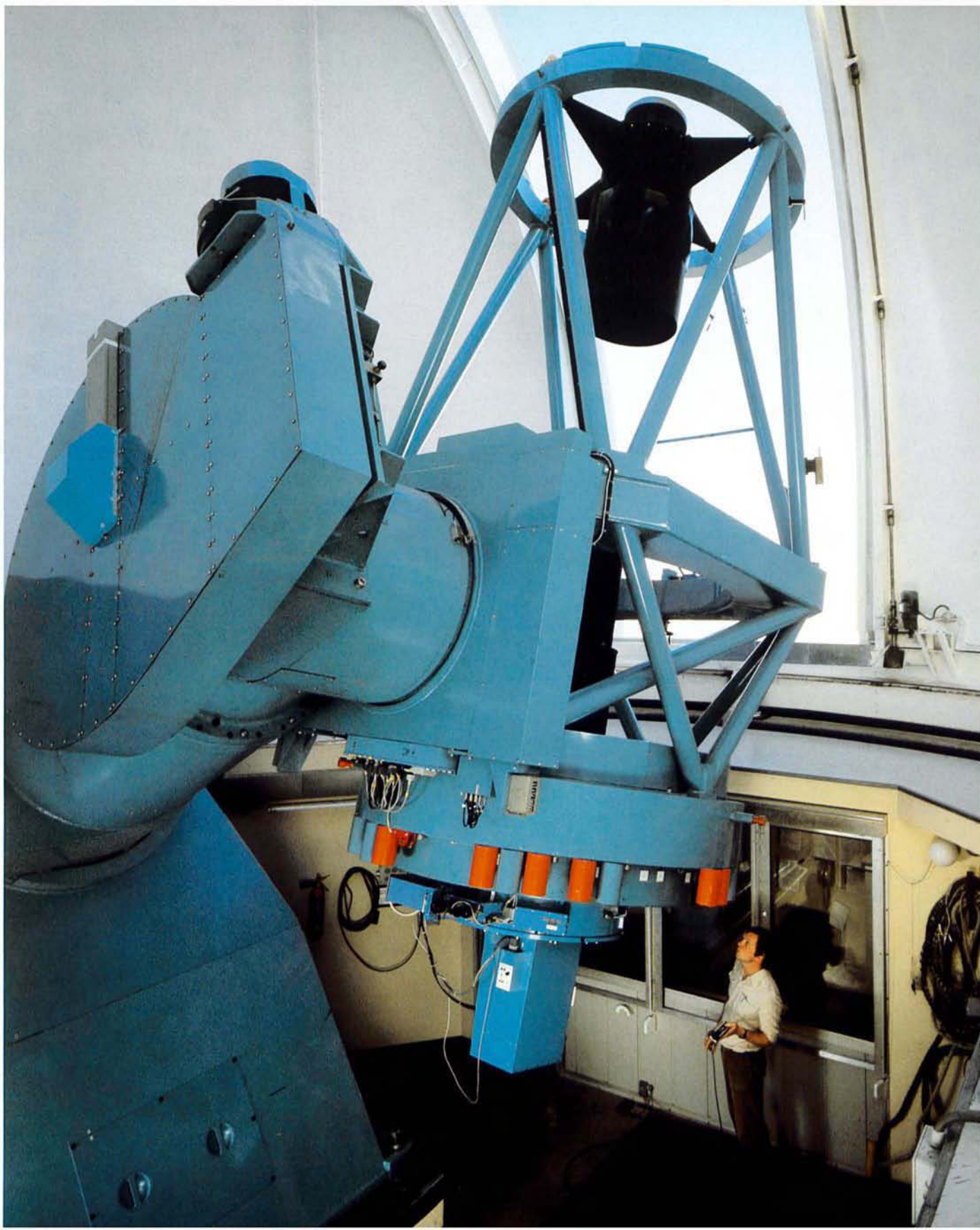



227 The first radio telescope at La Silla, the Swedish-ESO Submillimetre Telescope (SEST), went into regular operation in 1987. With a diameter of 15 metres, it will be unique, being the only large telescope in the southern hemisphere capable of operating at submillimetre wavelengths. As such it will help to fill the gap between the optical/infrared wavelengths and the much longer radio wavelengths. This spectral region is rich in lines from interstellar molecules, and SEST is particularly well-placed to study such molecules, as the centre and the inner regions of the Galaxy pass overhead, and the Magellanic Clouds are easily accessible. SEST will also be used to study a wide variety of other phenomena, ranging from objects in the Solar System to the active nuclei of distant galaxies, and the diffuse radiation left over from the beginnings of the Universe itself. At times it will form part of an intercontinental radio telescope, as one of several elements used for Very Long Baseline Interferometry.

La Silla is an important site for SEST on two counts. The first is its southern location and the second is the low absorption in the atmosphere above this dry mountain site. Most of the atmospheric absorption in the submillimetre spectral range is caused by water vapour. The water content in the air above La Silla is very small and early experience with the SEST shows the enormous improvement over a typical sea-level site.

The SEST reflector consists of 176 panels, which can be adjusted individually. After accurate adjustment, the reflector is now very near its optimal form. The deviations over the surface are less than 0.1 millimetre from the ideal shape. It is not excluded that the SEST may also be used for some types of observations, for instance in the infrared part of the spectrum, which do not require high angular resolution and for which the enormous light-collecting capacity of the SEST will be an advantage. In astronomical language, this mode of operation is referred to as the "light-bucket".

In astronomy, direct imaging serves two purposes: astrometry, that is the determination of positions in the sky, and photometry, which is the measurement of the apparent brightness of celestial objects in different spectral bands. The determination of astrophysical parameters like chemical composition and radial velocity is done by *spectroscopy*. Virtually all telescopes on La Silla carry spectroscopic equipment, such as the simple objective prisms of the GPO and the Schmidt telescope, or the highly sophisticated spectrographs used with the 3.6-m and 2.2-m telescopes.

During the past few years, several new spectroscopic instruments have entered operation at La Silla. Most of them were designed at ESO and manufactured by industrial firms in the member countries. In particular, an entirely new set of instruments was built for the 3.6-m telescope: a new Cassegrain Echelle Spectrograph (CASPEC), a Cassegrain Faint Object Spectrograph and Camera (EFOSC), a facility for multiple object spectroscopy (OPTOPUS) and a large infrared spectrograph (IRSPEC). These instruments, which are based on the latest techniques in electronics, optics and detectors, are in high demand not only by European astronomers, but also by scientists from other countries.

A minor revolution has taken place in the field of astronomical instrumentation during the past two decades. To illustrate the great advances, some of the main auxiliary instruments at ESO will be described.

THE CCD DETECTOR

A new type of detector is incorporated into several of the new ESO instruments: the CCD (short for Charge-Coupled Device). It has become the most important new imaging device in astronomy, and has replaced the photographic plate, the electronographic film and photomultipliers in a number of applications. The CCD is a solid-state detector, usually rather small, whose surface layer of silicon is covered by rows of transparent electrodes. By applying a voltage pattern to these electrodes, the silicon layer is divided by the electrical field into a series of individual picture elements, or pixels, much like the microscopic crystals in a photographic plate. The CCD resembles the photographic emulsion inasmuch as an electron is liberated when a photon strikes the surface. In photographic emulsions, these electrons attract mobile interstitial silver ions to create a "latent image" of silver in each crystal, while in the CCD they are accumulated in the pixels.

At the end of an exposure the electrical charge of each CCD element is measured; the higher the charge, the more photons were received. The numbers are stored in a computer or on magnetic tape and represent the two-dimensional distribution of photons, that is an image of the area of sky towards which the telescope was pointed. Since the elements are very efficient (they "catch" virtually every incident photon), much fainter details can be observed with a CCD than with a photographic plate, for instance.

Apart from the high quantum efficiency, the main advantages of the CCD lie in the quick and easy accessibility of the raw data, a linear response and a low read-out noise. CCD's are still in a relatively early state of development, and they are fairly small, although larger CCD's with up to 2000×2000 pixels are now becoming available. The total number of picture elements in a large photographic plate greatly surpasses that of a CCD, whereas the CCD is vastly superior in terms of light sensitivity and photometric accuracy. While the sensitivity of the photographic plate is remarkably uniform over the entire surface, CCD's often have greatly varying sensitivity from pixel to pixel, but this can be corrected during subsequent image processing of the CCD frames. For observations of small areas of sky and of individual objects, the CCD is now preferred to photography. However, when large areas of sky are observed at high angular resolution, the conventional photographic plate is still preferred. This situation may change once very large CCD's become available.

228 The ESO Faint Object Spectroscopic Camera (EFOSC) entered operation at the Cassegrain Focus of the 3.6-m telescope in 1985. It is dedicated to the photometric and spectroscopic study of faint objects, such as distant galaxies and quasars. It is one of the most efficient optical instruments ever built, and one of the most versatile. In a matter of seconds, the observer can switch between the five possible observing modes: direct imaging, slit prism spectroscopy, field prism spectroscopy, multi-slit spectroscopy, and echelle slit spectroscopy. Taking advantage of these possibilities during the night, the observers can make optimum use of their telescope time. For example, it is possible to do photometry and low-dispersion spectroscopy of the galaxies in a distant cluster and to study at moderate dispersion the spectrum of a background quasar found on the same night. The powerful performance of the Faint Object Camera is well illustrated by this picture of stars in the globular cluster ω Centauri. Stars of the 25th magnitude are easily seen here.



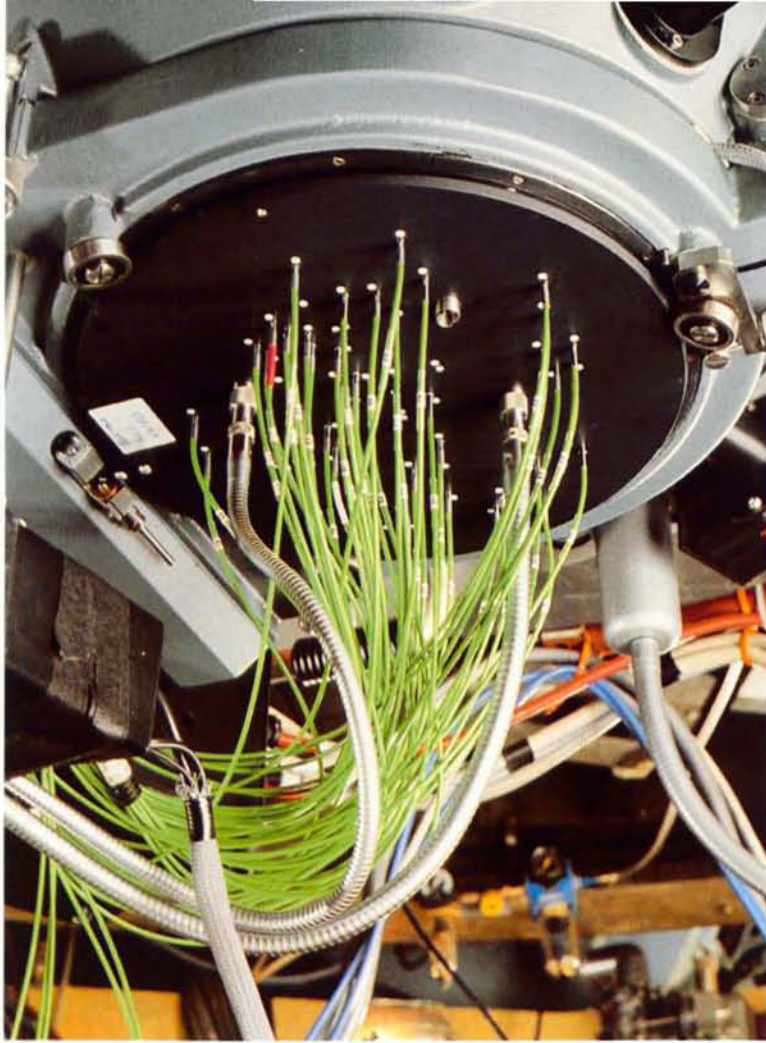

229 Some astrophysical investigations require the astronomer to take spectra of several objects that are situated within a small area of the sky. The measurement of radial velocities of individual galaxies in a cluster and surveys of stellar spectral types in clusters of stars are good examples of this type of work. In order to increase efficiency through simultaneous observation of several objects, an instrument called the OPTOPUS was developed at ESO. It is based on fibre optics and the use of a conventional slit spectrograph. The OPTOPUS adaptor frame is attached to the Cassegrain Focus of the 3.6-m telescope,

as seen here. It uses so-called “starplates”; templates in which accurately drilled holes allow optical fibres to be accurately positioned in the telescope’s focal plane. Each fibre leads the light from one celestial object to the slit of the spectrograph. For guiding, the images of two bright stars are fed by other fibres into a small CCD camera. The holes, and hence the optical fibres, can be positioned with high accuracy anywhere within the 33-arcminute-diameter field available on a “starplate”, allowing simultaneous observations of up to 48 different objects. With a CCD camera, the spectra of about 200 objects



of 18th magnitude can be recorded at medium resolution in one night.

230 In addition to observations at visible wavelengths, telescopes on La Silla are being increasingly used to explore the infrared region of the spectrum between 1 μm and 20 μm . In this spectral region, the atmospheric absorption is mainly caused by water molecules. Since the amount of water vapour in the air above La Silla is so small, infrared observations can be done here that would be difficult or even impossible at most other places.

Both the 1-m and 3.6-m telescopes are equipped with infrared photometers, which cover this wavelength range in a number of well-defined spectral bands and also provide for low resolution spectroscopy. Similar instrumentation is being built for the 2.2-m telescope. In order to achieve maximum sensitivity, the detectors and associated optics and filters are cryogenically cooled to temperatures as low as 1 K (one degree above absolute zero). Because both the telescope and the sky radiate strongly at infrared wavelengths, measurements must be made by rapidly alternating the instrument's field of view between the astronomical object of interest and a nearby region of the sky. This is normally achieved by using a specially designed, "wobbling" secondary mirror which is much smaller than, and replaces that used for visual observations. These photometers contain only single detector elements and cannot produce pictures of the type obtained in the visual region with photographic plates and CCD detectors. Images can nevertheless still be reconstructed from the signals measured as the telescope is stepped in a raster pattern over the region of sky. Using a specially designed "speckle interferometer" on the 3.6-m telescope, it is also possible to measure angular sizes smaller than the limit normally set by atmospheric seeing.

The most recently installed instrument, and also the most complex, is the infrared spectrometer IRSPEC, shown here. This is a scanning grating-spectrometer which is equipped with a 32-element linear array of InSb diodes as detector and covers the $1\ \mu\text{m}$ – $5\ \mu\text{m}$ spectral range at medium resolution. Optically, its design is similar to spectrometers used at visible wavelengths. Again, in order to minimize the effects of thermal background radiation, the complete instrument is cooled in a vacuum vessel to around 77 K with liquid nitrogen. Although currently



used at the Cassegrain focus of the 3.6-m telescope it is planned to transfer IRSPEC to the New Technology Telescope (see later) once it becomes operational.

Future infrared instrumentation plans include the use of two-dimensional array detectors, similar to the CCDs, which are just now becoming available, and which will make it possible to obtain true pictures of the infrared sky for the first time.

231 Soon after the decision to build the observatory on La Silla, the first ESO offices in Santiago were installed in what later became the ESO Guesthouse. It is a place for the many staff astronomers, technicians and visitors to rest and relax on their way to and from La Silla.

ESO originally established its offices and workshops in Santiago de Chile, but later most activities were transferred to La Silla itself. Today ESO keeps a small administrative contingent in Santiago.



ES+
O



4.3 *The Headquarters in Garching*

232 In parallel with the development of the observatory proper at La Silla, ESO's European base has undergone significant changes since the foundation of the organization.

With the establishment of the Telescope Project Division and the Scientific Division at CERN, the ESO European office was split into two separate units, because the administration remained in Hamburg. By 1975, however, ESO accepted a generous offer by the Federal Government of Germany, in the form of new Headquarters at Garching near Munich, an area which contains several national scientific institutes. In September 1980, the administration and the Geneva-based divisions were transferred to the new Headquarters building. For the first time since the early days, all of ESO-Europe was again together in one place, with ample space for all its activities.

233 With its modernistic and functional architecture, the ESO Headquarters building in Garching provides a striking framework for the various scientific, technical and administrative activities that have now transformed ESO-Europe into a major scientific centre.



234–235 The facilities at the ESO Headquarters include a series of well-equipped electronic, optical and mechanical laboratories, a major photographic laboratory, advanced measuring-machines (Plate 234), powerful computers to store and reduce observational data (Plate 235), a complete scientific and technical library, and working space for scientists, including conference facilities. Since 1984, ESO serves as the host institute for the Space Telescope European Coordinating Facility (ST/ECF), jointly operated by ESO and ESA, the European Space Agency. This group of scientists and engineers is responsible for the European involvement in the ESA/NASA Hubble Space Telescope. The direct connection of ground-based and space-based astronomy at ESO has been most beneficial for scientific and technical progress within astronomy and astrophysics in Europe, and beyond.



236 The photographic laboratories of ESO were established in 1972 to undertake the production of the ESO and ESO/SERC Sky Surveys, which are based on observations with two large Schmidt telescopes in the southern hemisphere, the one at La Silla, and another one operated for the Science and Engineering Research Council of the United Kingdom by the Royal Observatory, Edinburgh, at Siding Spring Observatory in Australia.

The first ESO survey, which was completed in 1978, was the so-called *ESO Quick Blue Survey (QBS)*. For this survey, blue-sensitive Kodak plates (IIa-O) were exposed for 60 minutes, reaching objects of 21st magnitude. This was 5 magnitudes deeper than any previous survey in the southern sky. After development at La Silla, the original plates were sent to the ESO photographic laboratories in Europe. Here they were copied and then stored away in a vault. The copy plates, now serving as masters, were used to obtain numerous copies on film or glass, which form the “ESO QBS Atlas”. It consists of 606 fields, together covering the southern sky from -17.5° declination to the celestial South Pole. The Atlas was distributed to astronomical institutes all over the world.

The copying procedure requires careful work by photographic specialists and also the use of some novel copying techniques. Whereas it is relatively easy to achieve near-perfect quality for single copies, it is a demanding task to maintain high quality for the tens of thousands of individual atlas copies. Having completed the QBS Atlas, the ESO laboratory has since been engaged in an even deeper, two-colour, sky survey. For this survey, a fine-grain photographic emulsion, Kodak Type IIIa, is used. The IIIa plates are available with different spectral sensitivities, a “J” version, which records mostly blue light, and a red-sensitive “F” version. The observational work has been divided between the ESO Schmidt, which takes the red plates, and the SERC Schmidt which takes the blue. All plates are subsequently copied at ESO in Garching and this Atlas consists of 1212 films or glass plates, covering the same area of sky as the ESO QBS Atlas.

In addition, the photographic laboratories of ESO perform a variety of other tasks related to astronomical and technical photography. Those include the regeneration of true-colour images of astronomical objects, such as the colour pictures in this book, and contrast-manipulating techniques aimed at extracting the maximum information from the photographic plates. The laboratory has established itself in a leading position as regards the developing, copying and processing techniques required by large-size photographic plates.



From the outset ESO was to be the focal point of European astronomy. This goal has been achieved in a number of ways. First and foremost, ESO has provided access to state-of-the-art telescopes and detectors for European astronomers. Secondly, ESO's own group of scientists and engineers interact closely with the scientific and technical communities of the member countries, as well as with overseas institutes and individuals. Most observational programmes at ESO are based on collaboration between astronomers in more than one member country, and often with ESO staff as well. These close links to national research institutes are vital, and ensure that ESO remains a dynamic organization able to fulfill its purpose of supporting and strengthening European research.

From an organizational point of view, this fruitful interaction is ensured by a number of committees set up to deal with various matters of importance. The main body is the ESO Council which consists of two representatives from each member country. The Council determines the policy of the organization with respect to scientific, technical and administrative matters, and is the ruling body of the organization. The Council is supported by a Finance Committee and a Scientific Technical Committee. Various working groups, comprised of members of the scientific community, give advice on different aspects of the VLT project (see later).

Most observers who use ESO's facilities come from national institutes in the member countries. They receive observing time on the basis of written applications dealt with by the Observing Programmes Committee. The work of this body is extremely important because the number of applications far exceeds the amount of available telescope time at La Silla. This committee therefore has the difficult task of selecting the most important research programmes from hundreds of scientifically interesting and well-founded applications. The Users Committee consists of observers and ESO technical and scientific staff, who together evaluate observation reports and comment on specific subjects, for instance various technical problems encountered during observing runs.

ESO also actively supports the flow of information among European scientists. This is done by sponsoring the renowned scientific journal "Astronomy and Astrophysics", and by publishing its own journal "The ESO Messenger". Other ESO publications include a large number of technical reports, reports and proceedings from numerous conferences and workshops organized by ESO at the Garching Headquarters and elsewhere in the member countries.

4.4 The Next Generation of Telescopes

The tremendous progress in observational astronomy during this century has led to increased demand for telescopes with big apertures. Observations in spectral bands not previously accessible are now possible with radio telescopes and satellites, and have added to the need for identification of optically faint objects. Astronomers quite naturally want to observe fainter and more distant objects than is now possible. There is a need for bigger telescopes which can reach beyond present limits in time and space. But telescopes of huge light-collecting power are expensive, and, furthermore, there are limits to the physical size that can be manufactured. A major limiting factor is the weight of the light-collecting primary mirror. A conventional 3.6-m mirror of low-expansion Zerodur glass-ceramic must have a thickness of about 50 cm in order to maintain its shape when the telescope points in different directions. Such a mirror weighs about 11 tons, and it takes a bulky and heavy support to hold it. An old rule of thumb says that the weight and the cost of a classical telescope increases with about the third power of the mirror diameter.

Fortunately, new ideas about telescope design have now led to important innovations in telescope technology that are being incorporated into ESO's new telescopes described below. The new approach will make it possible to build and operate much larger telescopes than the existing ones – and, most important, at a price considerably lower than that of conventionally designed instruments.

THE NEW TECHNOLOGY TELESCOPE (NTT)

237 ESO's first new generation telescope, now in the construction stage, is very appropriately termed the New Technology Telescope (NTT). Compared to the 3.6-m telescope, it will incorporate several new features. First, the NTT will be supported by an altazimuth mounting, which is simpler and cheaper than conventional equatorial mountings. It requires two-axis tracking, but with modern computer control this is no longer regarded as a major obstacle.



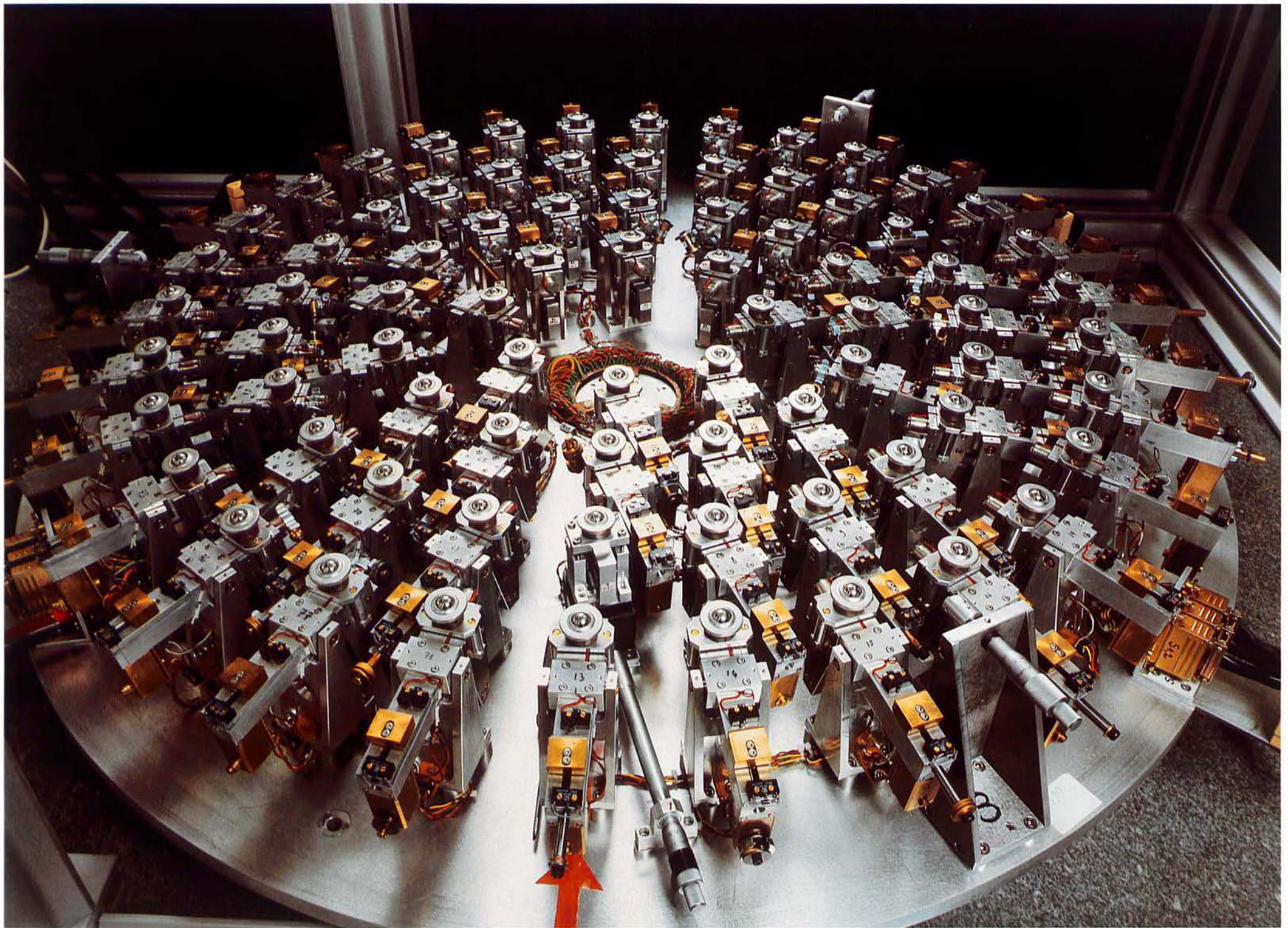

238 Another feature is the implementation of the “active mirror concept”. The ESO NTT primary mirror has a diameter of 3.58 m, and a thickness of only 24 cm. The weight is only six tons. Since the mirror is so much lighter, the entire telescope structure can be reduced considerably in weight, and a significant cost reduction is achieved. However, such a thin mirror will become deformed by its own weight when the telescope moves. To overcome this, a system has been developed at ESO (Fig. 31) by which an “image analyzer” (2) continuously monitors the shape of the mirror. Using the light from a stellar image in the focal plane (1) and the measured deviation from the ideal image shape, the computer (3) generates corrective signals for the supporting structures of the primary and secondary mirrors so that continuous optical perfection is ensured. Part of this system is the active support of the primary mirror, which has 75 active axial pads and three fixed supports. This photo shows the active mirror support of a 1-m test mirror set up in the optical laboratory at Garching.

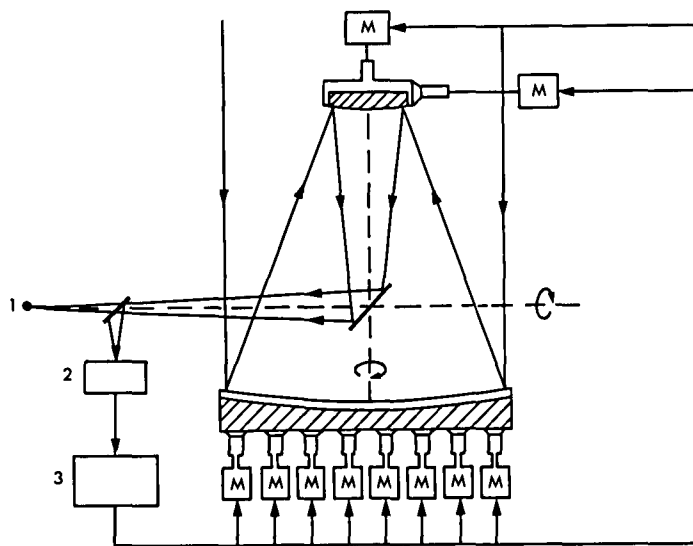

Fig. 31

Contrary to most conventional telescopes, the NTT has two Nasmyth foci only. The auxiliary instruments are permanently installed there. The present ESO 3.6-m telescope, by comparison, has three foci: a prime focus, a Cassegrain, and a coudé focus, resulting in frequent changes of the top unit.

Another novel feature is a new type of dome, designed on the basis of much accumulated knowledge about image deterioration due to air turbulence in classical domes. The possibility of remote control from the ESO Headquarters in Garching has been incorporated into the NTT as a future option.

Two aspects of the NTT project must be emphasized. With the consequent implementation of the latest technology, it is now possible to build a major telescope of the same size as the ESO 3.6-m at a substantially lower price. At the same time, however, the optical performance is expected to exceed that of the present telescope, albeit at the expense of abandoning the multi-purpose concept. When the NTT is installed at the ESO observatory in 1988, it will be one of the most technologically advanced telescopes in the world and it will relieve the present 3.6-m of some of the pressure generated by the large number of excellent applications for observing time. Equally important, the NTT will act as a testbed for ESO's Very Large Telescope Project (VLT), a 16-m-equivalent-aperture instrument planned for the 1990's.

OPPORTUNITIES FOR THE FUTURE: THE ESO VLT PROJECT

The performance of a telescope is dependent on a number of mechanical and optical parameters. The main determining factor is the size of its light-collecting surface, i.e. the primary mirror, which governs not only the light-gathering power of the telescope but also its angular resolving power. Astronomers naturally want to put larger reflectors to use. For many years, the prime reason for increasing the size of a reflector was to increase the light-collecting power, the resolution being limited by atmospheric conditions. However, new observational techniques, such as speckle interferometry, and new ideas about telescope design, notably the concepts of “active optics” (avoiding physical deformation of the primary mirror) and “adaptive optics” (eliminating the effects of atmospheric turbulence on the image) allow significantly improved angular resolution. Much bigger reflectors than those in existence therefore open entirely new vistas in astronomical research. A number of telescope projects in the 8–25-m range are currently under study.

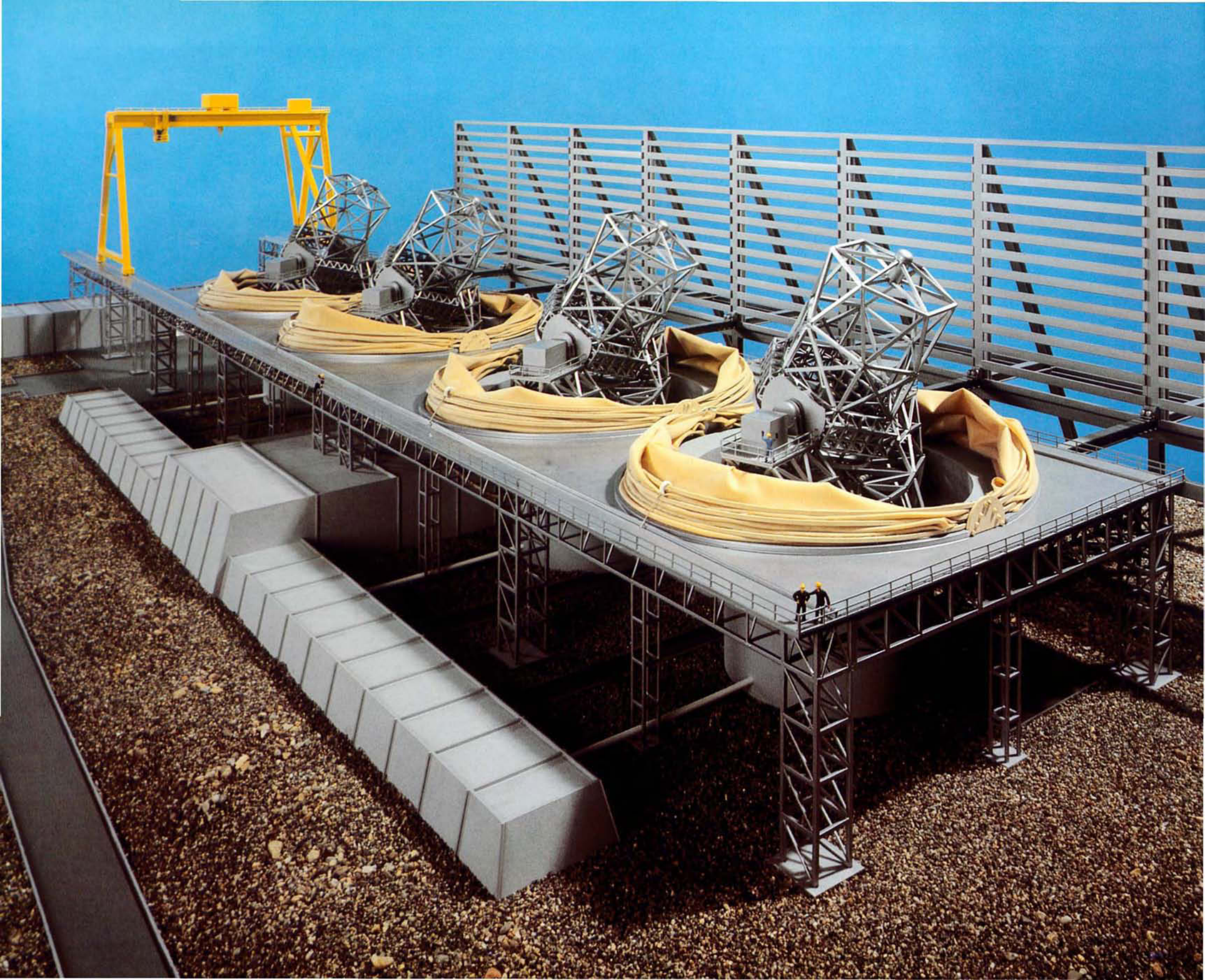

239 Plans are well advanced at ESO for an array of four 8-m telescopes, which, when working together, will have the same light-collecting power as one 16-m telescope, yet at times be able to function as four individual, giant instruments. A model is shown here. Since the angular resolution depends on the largest diameter of the light-collecting surface, one of the main advantages of the array concept is that when the four 8-m telescopes work together coherently, their resolution will be much higher than that of a single-dish instrument of similar light-collecting power. Another advantage is that the manufacture and handling of the 8-m reflectors is less complicated than of a 16-m dish. Still, the construction of an 8-m telescope is a formidable task. Developing and building an instrument of this size and complexity will have an important impact on European industry by fostering new ideas and know-how in important fields such as optics and electronics.

According to current estimates, the ESO 16-m VLT carries a price tag of 300 million DM. Although this is a fairly small amount of money as compared to the price of building and putting the 2.4-m Hubble Space Telescope into orbit, it represents a major investment in ground-based astronomy. It is necessary to ensure that such an instrument is placed at one of the best sites in the world. ESO is therefore conducting extensive site tests at a number of promising mountain peaks in northern Chile, and also at La Silla Observatory. By the time of site selection, ESO will have a vast amount of data at its disposal regarding seeing conditions, sky transparency, humidity, number of photometric nights, wind conditions, etc. which will permit a well-founded decision on where to place the VLT.

Technological challenges notwithstanding, telescopes are built for observing the Universe and the objects therein. Giant telescopes, such as the VLT, will mean a quantum leap in astronomy, as did the 5-m Hale Telescope on Mount Palomar, when it was commissioned in the late 1940's. Some of the major scientific goals for the VLT are concentrated around a better understanding of the early Universe, how it was formed, how galaxies were formed, and what is the origin of the enormous sources of energy in quasars. Other VLT research programmes will be concerned with the formation of the Solar System and the distribution and amount of dark matter in the Universe. However, some of the most important discoveries which will be made with the VLT cannot even be foreseen at present. Nature undoubtedly has many surprises in store for users of the VLT.

240 As the Sun sets on La Silla, day-time technicians make their way back to their quarters. For the astronomers and the night assistants it is time to proceed to the telescopes. But these few precious minutes are also time for the quiet contemplation and admiration of one of the most captivating spectacles that nature has to offer.

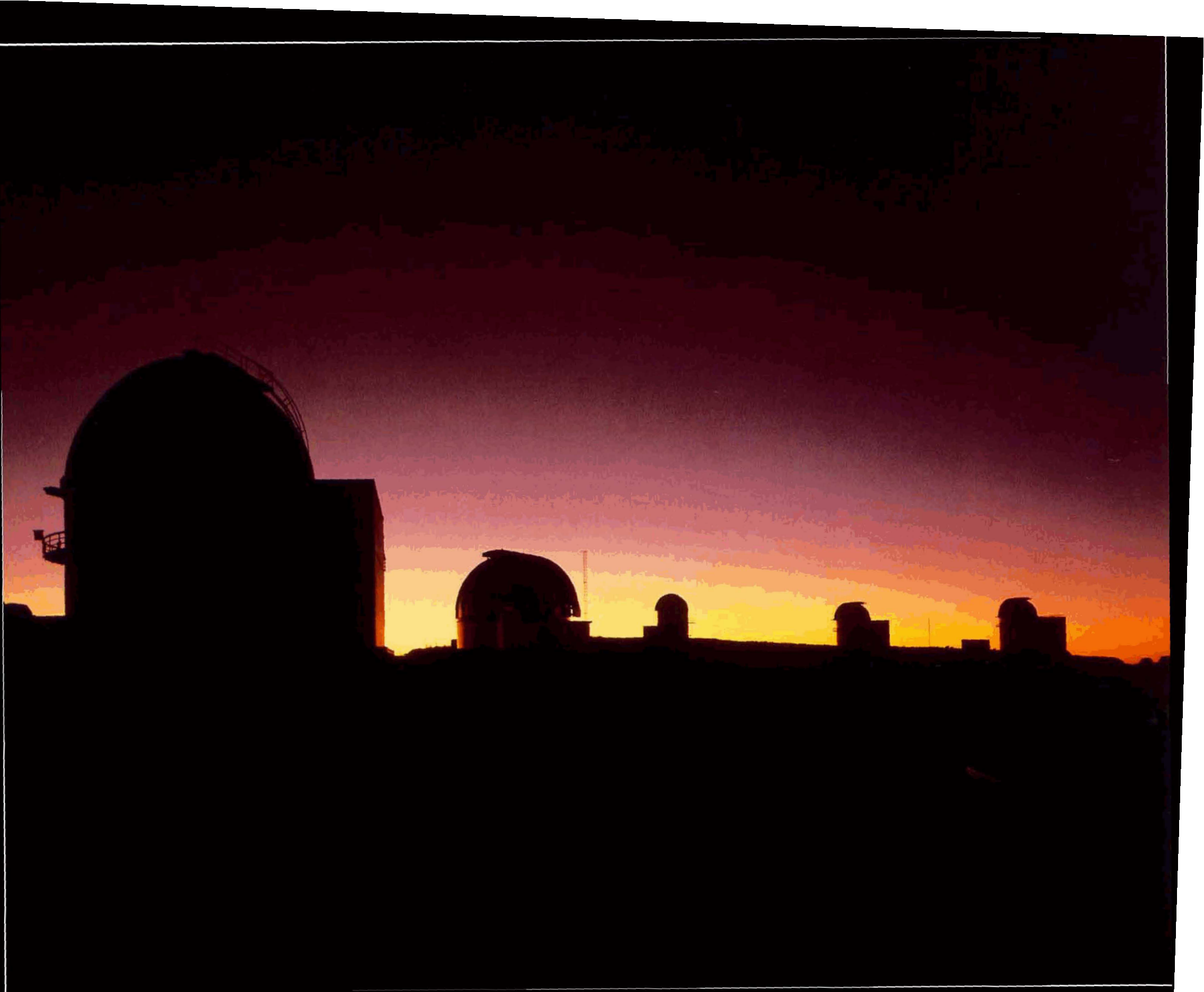

Glossary

This glossary contains brief explanations of some of the astronomical terms in this book. For some entries, a reference is made to where a further description can be found in the text, or where the term is illustrated by an example.

ABSORPTION dimming of the light from a star, due to material in space between the object and the observer.

ABSORPTION LINE area in the spectrum (wavelength) where little radiation is received, due to absorption by material in space between the emitting object and the observer (Plate 168).

ACCRETION DISK disk-shaped, gaseous body, which surrounds one component in a double-star system, as a result of transfer of material from the other component.

ACTIVE OPTICS optical system which automatically compensates for deformations of a telescope's mechanical and optical parts (Plate 238).

ADAPTIVE OPTICS active optical system which automatically compensates for image deterioration caused by turbulence in the atmosphere (page 253).

ANGULAR DISTANCE the distance between two celestial objects, as measured on the sky, for instance in degrees.

ANGULAR RESOLUTION the smallest angular distance under which two equally bright stars can still be discerned as individual objects by a particular telescope and detector.

APHELION the orbital point at which a Solar-System object is farthest from the Sun.

ASSOCIATION a loose group of mostly very young stars that are still close to the interstellar cloud from which they were born (Plate 126).

ASTEROID minor planet (diameter less than 1 000 km) in the Solar System (page 196).

ASTROMETRY the measurement of (accurate) positions on the sky (page 242).

A-TYPE STAR a star which is somewhat hotter and larger than the Sun (page 4).

BARRED GALAXY see galaxies, barred.

BILLION one thousand millions (1 000 000 000).

BLACK HOLE a very compact body, possibly the final evolutionary stage of heavy stars. Due to its small size and large mass, the gravitational field at the surface is strong enough to prevent light from escaping. Massive black holes are believed to be present in the nuclei of active galaxies (Plate 119).

BOK GLOBULES exceptionally dense, small interstellar nebulae of dust and gas (Plate 161).

BRIGHTNESS, APPARENT the brightness at which we observe a celestial object; often expressed in "magnitudes" (page 3).

B-TYPE STAR a hot and massive star (page 4).

CCD Charge-Coupled Device, a very sensitive, modern light detector (page 242).

CD GALAXIES see galaxies, cD

CEPHEID a type of star with variable luminosity, due to regular changes in size (pulsations). The luminosity can be deduced from the period of variability, making these stars very useful for distance determinations.

CLUSTER, GALACTIC an alternative term for open cluster.

CLUSTER, GLOBULAR a stellar cluster of spheroidal or ellipsoidal shape, mostly older than open star-clusters (Plates 173–175).

CLUSTER OF GALAXIES a group of galaxies in space that is kept together by mutual gravitational attraction (page 87).

CLUSTER, OPEN a stellar cluster of irregular shape, less well defined, and mostly younger than globular stellar clusters (Plate 152).

COMA the cloud of gas and dust that surrounds the nucleus of a comet.

COMET a Solar-System object consisting of a small nucleus of frozen gases and dust. When it is close enough to the Sun for partial melting of the nucleus to occur, a coma and one or more tails are formed (page 205).

COMETARY GLOBULE a dense area of interstellar clouds that becomes visible through the action of nearby, hot stars (Plate 135–137).

CONTINUUM part of a spectrum in which neither absorption nor emission lines are seen.

DECLINATION one celestial coordinate, corresponding to geographic latitude (page 2).

dE GALAXY see galaxies, dE

DENSITY-WAVE THEORY a theory concerned with the explanation of the origin of spiral arms in galaxies (Plate 73).

DISCONNECTION EVENT when part of a comet's tail becomes disconnected, due to the influence of the solar wind (Plate 203).

DISK a flattened sub-system of stars in some galaxies.

DOPPLER SHIFT the effect where light emitted by a moving object is shifted towards longer wavelengths if the source is receding from the observer, and towards shorter wavelengths if it is approaching. With visible light this causes a shift in the colour of the source (see redshift).

DWARF GALAXIES see galaxies, dwarf

ECLIPTIC the great circle in the sky along which the Sun moves during the year; it reflects the orbital motion of the Earth around the Sun.

ELEMENTS, HEAVY in astronomy, all elements heavier than hydrogen and helium.

- ELLIPTICAL GALAXY** see galaxy, elliptical
- EMISSION LINE** an area in spectrum (wavelength), where radiation is emitted by particular atoms, ions or molecules. In spectra of astronomical objects, emission lines are indicators of (hot) surrounding gas.
- EQUATOR, CELESTIAL** the great circle at declination 0° in the equatorial system of celestial coordinates.
- EQUATOR, GALACTIC** the great circle at galactic latitude 0° in the galactic system of celestial coordinates. Defines the galactic plane along which the band of the Milky Way is found.
- EQUINOX** the Equinox are the two points in the sky where the Ecliptic intersects the celestial equator. Because the celestial equator slowly moves (due to the motion of the Earth's rotational axis in space), all celestial coordinates must be specified to a particular Equinox. In this book, equinox 1950.0 is used throughout.
- EQUINOX, VERNAL** one of the two points in the sky where the Ecliptic intersects the celestial equator. The Sun is located here around March 21, when day and night have the same length.
- ESO/UPPSALA CATALOGUE OF GALAXIES** a catalogue of about 15000 galaxies in the southern sky, based on the ESO Quick Blue Survey (Lauberts, 1982).
- EXTRAGALACTIC** outside the Milky Way Galaxy (page 119).
- FALSE-COLOUR IMAGE** an image in artificial colours (most often generated by a computer programme), used in order to enhance contrast and to demonstrate certain properties of the image.
- FIELD GALAXY** see galaxy, field.
- FORMATION OF STARS** stars are born when a small region of an interstellar nebula contracts due to its own gravitation. This contraction stops when the central temperature and pressure become high enough for thermonuclear reactions to start. After a while, the remaining gas and dust around the star are blown away and the star becomes visible.
- GALACTIC DISK** the flattened sub-system of stars and nebulae in the Galaxy, containing the spiral arms. The stars are mainly of Population I type.
- GALACTIC EQUATOR** see equator, galactic.
- GALACTIC LATITUDE** one celestial coordinate in the galactic system (page 2).
- GALACTIC LONGITUDE** one celestial coordinate in the galactic system (page 2).
- GALACTIC PLANE** the main plane of the galactic disk. Exactly defined by the galactic equator.
- GALAXY, ACTIVE** a galaxy which emits an unusually large amount of energy.
- GALAXY, BARRED** a galaxy with a linear element running across the central area (spiral or irregular) (page 37).
- GALAXY, CD** a type of large galaxies found in central parts of some clusters of galaxies, often strong radio sources (Plate 9).
- GALAXY, CENTRE** the innermost region of the Milky Way Galaxy, possibly the site of a black hole (Plate 166).
- GALAXY, DE** a type of very small galaxies of elliptical (or spheroidal) shape, so far only detected in the neighbourhood of the Milky Way Galaxy (Plate 68).
- GALAXY, DWARF** a galaxy of any type that is smaller and less massive than normal (page 47).
- GALAXY, ELLIPTICAL** a galaxy of elliptical shape, classified E0–E7 according to its degree of flattening (page 17).
- GALAXY, FIELD** Galaxy not belonging to a cluster of galaxies.
- GALAXY, IRREGULAR** a galaxy of irregular shape (page 45).
- GALAXY, MAGELLANIC-TYPE** an irregular galaxy that resembles the Magellanic Clouds.
- GALAXY, PECULIAR** a galaxy that is unusual in some way or another, for instance by having a strange shape (page 99).
- GALAXY, RING** a galaxy with a ring-like structure, normally as a result of gravitational interaction with other galaxies (Plate 100–103).
- GALAXY, SEYFERT** a galaxy with broad emission lines in its spectrum, indicative of violent motions near the centre (Plate 119).
- GALAXY, SPIRAL** a galaxy with spiral structure, classified from Sa-Sd according to the appearance of its spiral structure (page 22).
- GLOBULAR CLUSTER** see clusters, globular.
- H α -LINE** the spectral line emitted by ionized hydrogen in the red spectral region (6563 Å).
- H II REGION** a region of ionized hydrogen in space.
- HALO** the spherical region around galaxies, thinly populated by stars and globular clusters (Plate 15).
- HERBIG-HARO OBJECT** a small bright area that is seen in interstellar nebulae, near newly-born stars (Plate 129).
- HOT SPOT** energetic areas near centres of galaxies, probably dense clusters of hot stars (Plate 32).
- HUBBLE CONSTANT** the ratio between the apparent velocity of recession of galaxies and their distance (Plate 6).
- INDEX CATALOGUE** Catalogue of nebulae and galaxies (Dreyer, 1895, 1908).
- IONIZATION** when a neutral atom loses one or more of its electrons, it is said to become ionized.
- IONS** ionized atoms.

INTERSTELLAR MATTER gas and dust in interstellar space; much of it is concentrated in interstellar nebulae.

IRREGULAR GALAXY see galaxy, irregular.

KELVIN temperature, measured from absolute zero (page 4).

LIGHT-YEAR an astronomical unit of distance (page 3).

LOCAL GROUP a group of about 30 galaxies, to which the Milky Way Galaxy belongs (page 47).

LOCAL SUPERCLUSTER a group of clusters of galaxies, to which the Local Group belongs (page 87).

LUMINOSITY the amount of electromagnetic radiation emitted by a celestial object (page 3).

MAGELLANIC-TYPE GALAXY see galaxies, Magellanic-type.

MAGNITUDES a commonly used system to express the brightness of a celestial object (page 3).

MASS LOSS when an object irreversibly loses material to surrounding space or to a nearby companion object (Plate 144).

METEOR the visual phenomenon ("shooting star") seen when a small particle burns up due to friction against the air molecules in the Earth's atmosphere (Plate 179).

METEOROID a small body (less than 100 metres) in the Solar System, which enters the Earth's atmosphere. Parts of it may survive the fall, and can later be found on the surface when they are known as meteorites (page 194).

MESSIER CATALOGUE Catalogue of Non-stellar Objects (Messier, 1771–1782) (Plate 47).

MILKY WAY the luminous band seen in the sky (page 119).

MILKY WAY GALAXY the galaxy to which the stars and nebulae in the Milky Way, as well as our Sun, belong (page 119).

MINOR PLANET a minor body (diameter less than 1000 km) in the Solar System (page 194).

MISSING-MASS PROBLEM a long-standing question about whether or not there is more material, that is more mass, in certain clusters of galaxies than can be detected with current observational methods. This problem has a direct bearing on the structure of the Universe; if a large amount of "invisible" mass exists, then the Universe may be finite and closed, if not, then it is infinite and open (Plate 94).

MOVING-CLUSTER METHOD a method by which the distance to nearby stellar clusters can be determined (Plate 124).

NEBULAE extended, diffuse objects in the sky, as opposed to stars.

NEUTRAL HYDROGEN atomic hydrogen (H) and, to a lesser extent, molecular hydrogen (H₂), present in interstellar clouds.

NEUTRON STARS extremely compact stars in which gravitational pressure is so strong that most of the individual electrons and protons have combined to form neutrons. The first neutron star was discovered 1967 as a pulsar (Plate 139).

NEW GENERAL CATALOGUE Catalogue of Nebulae and Clusters of Stars (Dreyer, 1888) (Plate 3).

NUCLEAR BULGE the spherical distribution of stars, close to the centre of a galaxy. Consists mainly of Population II stars (Plate 165).

NUCLEUS, COMETARY a small, solid body of frozen gases and dust in the Solar System. When heated, the material evaporates and forms the comet's coma and tail (Plate 191).

NUCLEUS OF GALAXY the innermost region of a galaxy, often the site of a powerful energy source, possibly a black hole (Plate 166).

OB ASSOCIATION a loose group (association) of young, hot stars of types O and B (Plate 126).

OORT CLOUD the hypothetical cloud of comets around the Solar System at a very large distance (Plate 192).

OPEN CLUSTER see cluster, open.

ORION ARM a spiral arm in the Milky Way Galaxy, and near which the Sun is situated (Plate 124).

O-TYPE STAR a very hot and massive star (page 4).

PANCAKE THEORY a theory that endeavours to explain how clusters of galaxies were formed in the early Universe.

PECULIAR GALAXY see galaxy, peculiar (page 99).

PERIHELION the orbital point at which a Solar-System object is closest to the Sun.

PHOTOMETRY the measurement of brightness (light intensity) (page 242).

PLANETARY NEBULA a small, gaseous nebula around a hot star at a late evolutionary stage (Plate 140).

POPULATIONS, STELLAR a convenient division of stars into different classes ("populations"), according to location in the Galaxy and content of heavy elements and, indirectly, according to age (Plate 5).

POPULATION I stars with an abundance of heavy elements, like the Sun, and mainly located in the galactic disk (Plate 122).

POPULATION II stars with a low abundance of heavy elements, mainly located in the galactic halo, in the nuclear bulge and in globular clusters. Older than stars of Population I (Plate 122).

- PULSAR** an astronomical object that emits regular pulses of electromagnetic radiation. First found by radio observations in 1967 and now interpreted as rapidly rotating neutron stars (Plate 139).
- QUASAR** a star-like, extragalactic object. Such objects are now believed to be the extremely bright nuclei of very distant galaxies (Plate 119).
- QUICK BLUE SURVEY** a photographic survey of the southern sky, undertaken at ESO from 1972 to 1978 (Plate 236).
- RADIAL VELOCITY** the speed with which an object moves along the line of sight. For distant galaxies, it is proportional to the distance (Plate 6).
- REDDENING** due to the selective absorption of light in interstellar dust clouds, an astronomical object appears redder than it really is, when seen through such a cloud. The degree of reddening is a measure of the amount of intervening dust (Plate 163).
- RED GIANT** a star which is cooler, but much larger and more luminous than the Sun (Plate 173).
- REDSHIFT** the shift of the lines in the spectrum of a receding object towards longer wavelengths. The lines in the visible part of the spectrum of a receding galaxy are shifted towards the red. The redshift is approximately proportional to the radial velocity (and therefore to the distance of the galaxy concerned) (Plate 6).
- REFLECTION NEBULA** an interstellar nebula which shines by the reflection of light from a nearby star (Plate 170).
- RIGHT ASCENSION** one celestial coordinate, corresponding to geographical longitude (page 2).
- RR LYRAE STARS** a class of variable stars that can be used for distance determination.
- RUN-AWAY STAR** a star which has been ejected from a stellar association at high speed (Plate 134).
- SCHMIDT TELESCOPE** a wide-field, photographic telescope (Plate 222).
- SEEING** the measure of turbulence in the Earth's atmosphere; the angular size of a stellar image as seen through a telescope. The seeing is normally the limiting factor governing the angular resolution of a large telescope.
- SEYFERT GALAXY** see galaxy, Seyfert.
- SOLAR LUMINOSITY** astronomical unit for emitted energy (page 3).
- SOLAR MASS** astronomical unit for mass (page 3).
- SOLAR WIND** the rapid flow of atoms, ions, and elementary particles from the Sun. Interacts with the interplanetary magnetic field.
- SPECKLE INTERFEROMETRY** a method that permits higher angular resolution to be achieved with an optical telescope than is normally possible. A series of very short exposures are made at very high magnification. These are later combined, whereby the random effects of atmospheric turbulence cancel out, leaving a high-resolution image of the astronomical object. This method has been successfully employed to see details on the surfaces of the nearest giant stars (Plate 57).
- SPECTRAL LINES** see absorption and emission lines.
- SPECTROSCOPY** the study of objects by analysis of their spectra. For example, spectroscopy allows the determination of temperature, luminosity, radius and mass of stars, as well as their age (page 242).
- SPIRAL GALAXY** see galaxies, spiral.
- STELLAR POPULATION** see population of stars.
- STELLAR WINDS** the rapid flow of atoms, ions and elementary particles, particularly violent from hot and luminous stars; see also solar wind (Plate 63).
- STRÖMGREN SPHERE** a region around a hot star in which the interstellar hydrogen has been ionized by the star's ultraviolet radiation (Plate 58).
- SUBGIANT** a large and luminous star, which is smaller than a giant star.
- SUPERCLUSTER** a group of clusters of galaxies (page 87).
- SUPERGIANT** the most luminous and massive type of stars known, up to 100 000 times more luminous than the Sun (Plate 126).
- SUPERNOVA** the explosion of a massive star towards the end of its evolution. Leaves a supernova remnant and sometimes a pulsar (Plate 13, 52–54, 138–139).
- SUPERNOVA REMNANT** a gaseous expanding nebula that is left behind after a supernova explosion (Plate 138–139).
- VOIDS** enormous, empty regions in space, bordered by superclusters of galaxies (page 87).
- WHITE DWARF STARS** dense, small and hot stars, probably the final stage in the evolution of less massive stars.
- WOLF-RAYET STARS** massive and luminous stars surrounded by large and hot gaseous envelopes, often members of binary star systems (Plate 63 and 132).
- ZONE OF AVOIDANCE** the area of sky along the band of the Milky Way in which few or no external galaxies are seen, due to heavy obscuration by interstellar clouds in the galactic disk (Plate 29).

List of Plate Data

The list contains the following information:

Column 1: Plate number.

Column 2: Name or catalogue number of object or name of field.

Column 3: Right Ascension for equinox 1950.0

Column 4: Declination for equinox 1950.0
For plates containing a main object the celestial position (see page 2) of this is given with an accuracy of 0^m.1 in R.A. and 1' in Decl.

For Plates of fields with no main object the position of the Plate centre is given with an accuracy of 1^m in R.A. and 1° or 0°.1 in Decl.

Column 5: The telescope or the type of camera used. The following abbreviations are applied:

3.6 3.6 m telescope
(see Plates 214–218)

S Schmidt telescope
(see Plate 222)

2.2 2.2 m telescope
(see Plate 225)

1.5 1.5 m Danish telescope
(see Plate 226)

GPO The GPO telescope
(see page 122)

HSWC Hasselblad (Super Wide) camera Zeiss Biogon
1:4.5/38 mm

H Hasselblad camera with
Zeiss Planar 1:2.0/100

35 SLR 35 mm single lens reflex camera fitted with a standard lens ($f \sim 50$ mm).

WFCC ESO wide field
CCD camera

Column 6: For photographs the type of emulsion used is given.
For CCD pictures the letters CCD are quoted.

Column 7: The types of filters used are listed. The following abbreviations are applied.

B Johnson B (blue) filter

V Johnson V (visual) filter

r Gunn r (red) filter

z Gunn z (infrared) filter

H_α Narrow band H_α filter (see page 259)

Column 8: The exposure time(s) in minutes, unless otherwise stated.

Column 9: The image scale of the printed Plate. (see page 2)

Column 10: The observer who made the picture at the telescope. The following abbreviations are applied:

NB	N. Bergvall	OP	O. Pizarro
JB	J. Boulesteix	BR	B. Reipurth
GC	G. Courtès	GS	G. Schnur
AD	A. Danks	HS	H.-E. Schuster
HD	H. Duerbeck	JPS	J.P. Sivan
BG	B. Gelly	PS	P. Stättmayer
RH	R. Häfner	AS	A. Surdej
SL	S. Laustsen	JS	J. Surdej
PL	P.O. Lindblad	MT	M. Tarenghi
CM	C. Madsen	MV	M.-P. Véron-Cetty
BN	B. Niss	PV	P. Véron
HP	H. Pedersen	RV	R. Vio
GP	G. Pizarro	RW	R.M. West

Plate	Object	R.A. (1950)	Decl.	Telescope or camera	Emulsion or detector	Filter	Exposure time in minutes	Plate scale 1 cm equal to	Observer
(1)	(2)	(3)	(4)	(5)	(6)	(7)	(8)	(9)	(10)
1	LMC	5 ^h 24 ^m 0	-69°48'	H	EPD-200	—	30	42'	CM
2	Field in Fornax	3 ^h 28 ^m	-29°	S	II a-O	GG 385	60	6.9	OP, GP
3	Fornax Cluster	3 ^h 34 ^m	-35°	S	II a-O	GG 385	60	6.9	OP, HS
4	NGC 1365	3 ^h 31 ^m 7	-36°18'	3.6	III a-J	GG 385	120	34''	PL
5	NGC 1365	3 ^h 31 ^m 7	-36°18'	S	{II a-O 127-04	{GG 385 RG 630	{60 90}	37''	HS, OP
6	NGC 1350	3 ^h 29 ^m 2	-33°48'	3.6	III a-J	GG 385	60	36''	SL
7	NGC 1427A	3 ^h 37 ^m 7	-35°47'	3.6	III a-J	GG 385	90	16''	SL
8	Hubble's sequence	—	—	S	II a-O	GG 385	60	var.	HS, OP, GP
9	NGC 3309/11	10 ^h 34 ^m 2	-27°16'	3.6	III a-J	GG 385	90	16''	SL
10	NGC 3309/11	10 ^h 34 ^m 2	-27°16'	3.6	III a-J	GG 385	15	16''	SL
11	NGC 6861	20 ^h 3 ^m 7	-48°31'	1.5	CCD	{ ^B r z	{ ¹⁰ 5 ¹⁰	22''	PV, MV
12	NGC 5128	13 ^h 22 ^m 5	-42°45'	3.6	III a-J	GG 385	60	24''	SL
13	NGC 5128, SN 1986 G	13 ^h 22 ^m 5	-42°45'	GPO	II a-O	neutral	90	24''	HD
14	NGC 5128	13 ^h 22 ^m 5	-42°45'	3.6	III a-J	GG 385	60	40''	SL
15	NGC 5128	13 ^h 22 ^m 5	-42°45'	S	III a-F	RG 630	120	1.8	GP
16	M 104	12 ^h 37 ^m 4	-11°21'	3.6	{III a-J III a-J 127-04	{GG 385 UG 1 RG 630	{ ⁵⁰ 150 120}	14.5	SL
17	M 104	12 ^h 37 ^m 4	-11°21'	3.6	III a-J	GG 385	50	34''	SL
18	M 104	12 ^h 37 ^m 4	-11°21'	3.6	III a-J	GG 385	1	19''	SL
19	M 104	12 ^h 37 ^m 4	-11°21'	S	III a-F	RG 630	120	1.8	HS
20	NGC 7742	23 ^h 41 ^m 8	+10°29'	1.5	CCD	{ ^B r z	{ ¹⁰ 10 10}	26''	PV, MV
21	NGC 6887	20 ^h 13 ^m 4	-52°57'	1.5	CCD	{ ^B r z	{ ¹⁰ 10 10}	26''	PV, MV
22	M 77	2 ^h 40 ^m 1	- 0°13'	1.5	CCD	{ ^B r z	{ ^{1.5} 0.7 1}	26''	PV, MV
23	NGC 134	0 ^h 27 ^m 9	-33°31'	1.5	CCD	{ ^B r z	{ ¹⁰ 10 10}	26''	PV, MV
24	NGC 7769	23 ^h 48 ^m 5	+19°52'	1.5	CCD	{ ^B r z	{ ¹⁰ 3 10}	26''	PV, MV
25	NGC 6814	19 ^h 39 ^m 9	-10°27'	1.5	CCD	{ ^B r z	{ ¹⁰ 10 10}	26''	PV, MV
26	NGC 7314	22 ^h 33 ^m 0	-26°18'	1.5	CCD	{ ^B r z	{ ¹⁰ 10 10}	26''	PV, MV
27	NGC 157	0 ^h 32 ^m 3	- 8°40'	1.5	CCD	{ ^B r z	{ ¹⁰ 10 10}	26''	PV, MV
28	NGC 6744	19 ^h 5 ^m 0	-63°56'	3.6	III a-J	GG 385	60	38''	SL
29	NGC 6221	16 ^h 48 ^m 4	-59° 8'	3.6	III a-J	GG 385	60	20''	SL
30	NGC 1808	5 ^h 6 ^m 0	-37°35'	3.6	III a-J	GG 385	90	22''	SL
31	NGC 1808	5 ^h 6 ^m 0	-37°35'	3.6	III a-J	GG 385	30	22''	SL
32	NGC 1808	5 ^h 6 ^m 0	-37°35'	1.5	CCD	{ ^B r z	{ ³ 3 3}	3.4	PV, MV
33	NGC 2997	9 ^h 43 ^m 5	-30°58'	3.6	III a-J	GG 385	90	26''	SL

Plate	Object	R.A. (1950)	Decl.	Telescope or camera	Emulsion or detector	Filter	Exposure time in minutes	Plate scale 1 cm equal to	Observer
(1)	(2)	(3)	(4)	(5)	(6)	(7)	(8)	(9)	(10)
34	NGC 2997	9 ^h 43 ^m 5	−30°58′	1.5	CCD	V	15, 15, 15*	9″6	HP
35	NGC 4945	13 ^h 2 ^m 5	−49°12′	3.6	III a-J	GG 385	60	26″	SL
36	ESO 60 – IG 23	9 ^h 2 ^m 8	−68° 6′	3.6	III a-J	GG 385	30	14″	SL
37	IC 5152	21 ^h 59 ^m 6	−51°32′	3.6	III a-J	GG 385	60	9″6	SL
38	NGC 6684	18 ^h 44 ^m 0	−65°14′	3.6	III a-J	GG 385	40	37″	SL
39	NGC 5101	13 ^h 19 ^m 0	−27°10′	3.6	III a-J	GG 385	90	21″	SL
40	NGC 5101	13 ^h 19 ^m 0	−27°10′	3.6	III a-J	GG 385	90	8″4	SL
41	NGC 6300	17 ^h 12 ^m 3	−62°46′	3.6	III a-J	GG 385	40	13″	SL
42	NGC 2442	7 ^h 36 ^m 5	−69°25′	3.6	III a-J	GG 385	60	25″	SL
43	NGC 357	1 ^h 0 ^m 8	− 6°36′	1.5	CCD	$\left. \begin{matrix} B \\ r \\ z \end{matrix} \right\}$	$\left. \begin{matrix} 10 \\ 10 \\ 10 \end{matrix} \right\}$	22″	PV, MV
44	NGC 289	0 ^h 50 ^m 4	−31°29′	1.5	CCD	$\left. \begin{matrix} B \\ r \\ z \end{matrix} \right\}$	$\left. \begin{matrix} 10 \\ 10 \\ 10 \end{matrix} \right\}$	22″	PV, MV
45	NGC 6923	20 ^h 28 ^m 6	−31° 0′	1.5	CCD	$\left. \begin{matrix} B \\ r \\ z \end{matrix} \right\}$	$\left. \begin{matrix} 10 \\ 10 \\ 10 \end{matrix} \right\}$	22″	PV, MV
46	NGC 7496	23 ^h 7 ^m 0	−43°42′	1.5	CCD	$\left. \begin{matrix} B \\ r \\ z \end{matrix} \right\}$	$\left. \begin{matrix} 10 \\ 10 \\ 10 \end{matrix} \right\}$	22″	PV, MV
47	M 83	13 ^h 34 ^m 2	−29°37′	3.6	III a-J	GG 385	40	27″	SL
48	M 83	13 ^h 34 ^m 2	−29°37′	3.6	Special	H _α	20	25″	JB, GC
49	NGC 3109	10 ^h 0 ^m 8	−25°55′	3.6	III a-J	GG 385	60	28″	SL
50	South Polar area	10 ^h 0 ^m	−77°	H	153-01	—	90	2″2	CM
51	LMC	5 ^h 24 ^m 0	−69°48′	S	$\left. \begin{matrix} IIa-O \\ IIa-D \\ 098-04 \end{matrix} \right\}$	$\left. \begin{matrix} GG 385 \\ GG 495 \\ RG 630 \end{matrix} \right\}$	$\left. \begin{matrix} 60 \\ 40 \\ 60 \end{matrix} \right\}$	11′	GP, OP, HS
52	LMC	5 ^h 24 ^m	−69°48′	H	Agfa-1000	—	20	33′	CM
53	LMC	5 ^h 24 ^m	−69°48′	H	Agfa-1000	—	20	33′	CM
54	30 Dor, SN 1987A	5 ^h 35 ^m 8	−69°18′	S	$\left. \begin{matrix} IIa-O \\ 103a-D \\ 098-04 \end{matrix} \right\}$	$\left. \begin{matrix} GG 385 \\ GG 495 \\ RG 630 \end{matrix} \right\}$	$\left. \begin{matrix} 60 \\ 45 \\ 60 \end{matrix} \right\}$	4′1	GP
55	LMC	5 ^h 24 ^m 0	−69°48′	S	$\left. \begin{matrix} IIa-O \\ IIa-D \\ 098-04 \end{matrix} \right\}$	$\left. \begin{matrix} GG 385 \\ GG 495 \\ RG 630 \end{matrix} \right\}$	$\left. \begin{matrix} 60 \\ 40 \\ 60 \end{matrix} \right\}$	4′9	GP, OP, HS
56	30 Doradus	5 ^h 39 ^m 9	−69° 4′	3.6	III a-F	RG 630	60	2′3	MT
57	30 Doradus	5 ^h 39 ^m 9	−69° 4′	3.6	127-04	RG 630	2	22″	SL
58	30 Dor. area	5 ^h 44 ^m	−69°6′	S	III a-F	RG 630	120	3′2	GP
59	30 Dor. area	5 ^h 39 ^m	−69°3′	S	III a-F	RG 630	120	3′2	GP
60	Field in LMC	5 ^h 18 ^m	−69°6′	3.6	III a-J	GG 385	20	1′1	SL
61	Field in LMC	5 ^h 32 ^m	−67°7′	3.6	III a-J	GG 385	20	52″	SL
62	NGC 1809	5 ^h 2 ^m 4	−69°38′	S	III a-F	RG 630	120	25″	GP
63	N 70	5 ^h 43 ^m	−67°9′	S	$\left. \begin{matrix} IIa-O \\ IIa-D \\ IIIa-J \end{matrix} \right\}$	$\left. \begin{matrix} GG 385 \\ GG 495 \\ RG 630 \end{matrix} \right\}$	$\left. \begin{matrix} 60 \\ 40 \\ 120 \end{matrix} \right\}$	1′1	GP, OP
64	SMC	0 ^h 51 ^m 1	−73° 6′	S	$\left. \begin{matrix} IIa-O \\ 103a-D \\ IIIa-F \end{matrix} \right\}$	$\left. \begin{matrix} GG 385 \\ GG 495 \\ RG 630 \end{matrix} \right\}$	$\left. \begin{matrix} 60 \\ 40 \\ 90 \end{matrix} \right\}$	5′8	GP
65	Field in SMC	0 ^h 49 ^m	−73°5′	3.6	III a-J	GG 385	15	1′1	SL
66	Sag DIG	19 ^h 27 ^m 9	−17°47′	3.6	III a-J	GG 385	90	29″	SL
67	NGC 6822	19 ^h 42 ^m 1	−14°56′	1.5	L4	B	120	24″	SL
68	Sculptor dE	0 ^h 57 ^m 6	−33°58′	S	II a-O	GG 385	60	2′9	GP

Plate	Object	R.A. (1950)	Decl.	Telescope or camera	Emulsion or detector	Filter	Exposure time in minutes	Plate scale 1 cm equal to	Observer
(1)	(2)	(3)	(4)	(5)	(6)	(7)	(8)	(9)	(10)
69	Carina dE	6 ^h 40 ^m 4	− 50°55′	S	II a-O	GG 385	60	2:6	OP, HS
70	Fornax dE	2 ^h 37 ^m 8	− 34°44′	S	II a-O	GG 385	60	2:6	GP, OP
71	NGC 300	0 ^h 52 ^m 5	− 37°57′	3.6	{ II a-O II a-D 098-04	GG 385 GG 495 RG 630	{ 45 45 60	51"	RW, MA
72	NGC 300	0 ^h 52 ^m 5	− 37°57′	3.6		II a-O			
73	NGC 7793	23 ^h 55 ^m 2	− 32°52′	3.6	III a-J	GG 385	40	21"	SL
74	NGC 253	0 ^h 45 ^m 1	− 25°34′	2.2	II a-O	neutral	40	52"	MT
75	SDIG	0 ^h 5 ^m 6	− 34°51′	3.6	III a-J	neutral	120	10"	SL
76	NGC 55	0 ^h 12 ^m 4	− 39°28′	3.6	{ II a-O II a-D 098-04	GG 385 GG 495 RG 630	{ 45 45 60	1:3	RW
77	NGC 247	0 ^h 44 ^m 7	− 21° 2′	S		II a-O			
78	NGC 6769-71	19 ^h 13 ^m 9	− 60°36′	3.6	III a-J	GG 385	100	19"	SL
79	NGC 6769-71	19 ^h 13 ^m 9	− 60°36′	3.6	III a-J	GG 385	100	28"	SL
80	NGC 5426-27	14 ^h 0 ^m 8	− 5°48′	3.6	III a-J	GG 385	40	18"	SL
81	NGC 87-89/92	0 ^h 19 ^m 1	− 48°54′	3.6	III a-J	GG 385	90	24"	SL
82	ESO 137 – IG 44	16 ^h 46 ^m 4	− 61°44′	3.6	III a-J	GG 385	40	18"	SL
83	ESO 124 – G 18-19	8 ^h 30 ^m 6	− 59°37′	3.6	III a-J	GG 385	60	14"	SL
84	NGC 6438-6438A	18 ^h 9 ^m 4	− 85°26′	3.6	III a-J	GG 385	90	11"	SL
85	NGC 6845	19 ^h 57 ^m 4	− 47°12′	3.6	III a-J	GG 385	105	22"	SL
86	ESO 161 – IG 24	6 ^h 43 ^m 2	− 56°38′	3.6	III a-J	GG 385	40	7:1	SL
87	ESO 273 – IG 04	14 ^h 45 ^m 4	− 43°43′	3.6	III a-J	GG 385	60	12"	SL
88	IC 2554	10 ^h 7 ^m 5	− 66°47′	3.6	III a-J	GG 385	60	18"	SL
89	ESO 179 – IG 13	16 ^h 43 ^m 1	− 57°20′	3.6	III a-J	GG 385	90	10"	SL
90	ESO 249 – G 35-36	3 ^h 57 ^m 7	− 46° 1′	3.6	III a-J	GG 385	120	20"	HS
91	IC 5174-75	22 ^h 9 ^m 8	− 38°25′	S	{ II a-O III a-J	GG 385 RG 630	{ 60 120	13"	OP, HS
92	NGC 4038-39	11 ^h 59 ^m 3	− 18°35′	S		{ II a-O III a-J			
93	NGC 4038-39	11 ^h 59 ^m 3	− 18°35′	3.6	III a-J		GG 385	60	35"
94	Virgo Cluster	12 ^h 17 ^m	+ 13	S	II a-O	GG 385	60	9:1	HS
95	Hydra I Cluster	10 ^h 34 ^m	− 27°	S	II a-O	GG 385	60	4:2	GP, OP
96	Pavo Group	20 ^h 13 ^m	− 71°	S	II a-O	GG 385	60	1:3	OP
97	Klemola 44	23 ^h 45 ^m	− 28°	S	{ II a-O 103 a-D 098-04	GG 385 GG 495 RG 630	{ 60 45 75	1:4	HS
98	IC 2082 Cluster	4 ^h 28 ^m	− 53°	3.6		III a-J			
99	Dist. Cl. of Gal.	13 ^h 25 ^m	− 31°	S	III a-F	RG 630	120	3:2	GP
100	ESO 138 – IG 29-30	17 ^h 24 ^m 5	− 62°24′	3.6	III a-J	GG 385	90	20"	SL
101	ESO 316 – IG 32/G 33	10 ^h 7 ^m 0	− 38° 9′	3.6	III a-J	GG 385	60	11:5	SL
102	ESO 316 – IG 32/G 33	10 ^h 7 ^m 0	− 38° 9′	3.6	III a-J	GG 385	5	11:5	SL
103	ESO 034 – IG 11	6 ^h 44 ^m 4	− 74°11′	3.6	III a-J	GG 385	120	26"	SL
104	Centaurus Chain	12 ^h 42 ^m	− 40°5′	3.6	III a-J	GG 385	90	29"	SL
105	NGC 4650A	12 ^h 42 ^m 0	− 40°26′	3.6	III a-J	GG 385	90	7:8	SL
106	IC 4329 Cluster	13 ^h 47 ^m	− 30°	S	III a-F	RG 630	120	2:7	OP
107	NGC 5291	13 ^h 44 ^m 6	− 30°10′	3.6	III a-J	neutral	60	38"	SL
108	ESO 400 – G 43	20 ^h 34 ^m 5	− 35°40′	2.2	CCD	Gunn I	20	5:7	NB

Plate	Object	R.A. (1950)	Decl.	Telescope or camera	Emulsion or detector	Filter	Exposure time in minutes	Plate scale 1 cm equal to	Observer
(1)	(2)	(3)	(4)	(5)	(6)	(7)	(8)	(9)	(10)
109	ESO 400 – G 43 area	20 ^h 34 ^m 5	– 35°40′	2.2/VLA	CCD	Gunn I	20	5″.7	NB, SJ
110	NGC 613	1 ^h 32 ^m 0	– 29°40′	3.6	IIIa-J	GG 385	60	20″	SJ
111	NGC 613	1 ^h 32 ^m 0	– 29°40′	1.5	CCD	{ B r z }	{ 30, 30, 30, 30* 15, 15, 15, 15 15, 15, 15, 15, 15, 15 }	22″	SJ, PL
112	NGC 613	1 ^h 32 ^m 0	– 29°40′	1.5	CCD	{ B H _α }	{ 30, 30, 30, 30* 20, 20, 20, 20 }	24″	SJ, PL
113	NGC 613	1 ^h 32 ^m 0	– 29°40′	1.5	CCD	{ B H _α OIII }	{ 30, 30, 30, 30* 20, 20, 20, 20 20, 20, 10, 10 }	3″.7	SJ, PL
114	NGC 454	1 ^h 12 ^m 3	– 55°40′	3.6	IIIa-J	GG 385	90	7″.6	NB
115	ESO 341 – IG 04	20 ^h 38 ^m 0	– 38°22′	3.6	IIIa-J	GG 385	75	7″.0	NB
116	ESO 060 – IG 26 – G 27	9 ^h 3 ^m 8	– 71°51′	3.6	IIIa-J	GG 385	100	14″	SL
117	M 87	12 ^h 28 ^m 3	+ 12°40′	1.5	IIa-O	GG 385	45	7″.3	MT
118	M 87	12 ^h 28 ^m 3	+ 12°40′	1.5	IIa-O	GG 385	45	2″.6	MT
119	ESO 113 – IG 45	1 ^h 21 ^m 8	– 59° 4′	3.6	IIIa-J	GG 385	60	11″	AD
120	ESO 113 – IG 45	1 ^h 21 ^m 8	– 59° 4′	3.6	IIIa-J	GG 385	10	11″	AD
121	NGC 6188	16 ^h 35 ^m 9	– 48°55′	3.6	{ IIa-O IIa-D 098-04 }	{ GG 385 GG 495 RG 630 }	{ 45 45 60 }	2″.6	RW
122	Milky Way	–	–	HSWC	TP-2415/153-01	–	60/90	6″.7**	CM, SL
123	–	–	–	–	–	–	–	–	–
124	Orion-Puppis	6 ^h 33 ^m	+ 8°	HSWC	153-01	–	90	2″.7	CM
125	Orion Complex	5 ^h 0 ^m	+ 4°	Special	103a-E	H _α	210	4″.9	JPS
126	Orion	5 ^h 25 ^m	0°	H	EPD-200	–	20	1″.1	PS
127	Orion Nebula	5 ^h 32 ^m 9	– 5°25′	2.2	IIa-O	neutral	20	1″.0	MT
128	Orion Nebula	5 ^h 32 ^m 9	– 5°25′	3.6	098-04	H _α	60	3″.7	MT
129	Stellar jet	5 ^h 33 ^m 0	– 6°28′	1.5	CCD	r	30	6″.2	BR
130	Horsehead	5 ^h 38 ^m 6	– 2°26′	3.6	103a-E	GG 495	60	40″	SL
131	NGC 2467	7 ^h 51 ^m 3	– 26°16′	3.6	IIIa-J	GG 385	20	31″	SL
132	Vela	9 ^h 0 ^m	– 51°	H	EPD-200	–	60	47″	CM
133	Carina – Crux	11 ^h 8 ^m	– 63°	H	EPD-200	–	90	47″	CM
134	Gum Nebula	8 ^h 44 ^m	– 43°	Special	103a-E	H _α	225	2″.3	JPS
135	Cometary Globules	8 ^h 7 ^m 7	– 35°56′	S	IIIa-F	RG 630	120	2″.2	GP
136	Cometary Globule	7 ^h 17 ^m 9	– 44°30′	S	IIIa-F	RG 630	120	1″.1	OP, HS
137	Cometary Globules	7 ^h 32 ^m 7	– 46°48′	S	IIIa-F	RG 630	120	2″.1	OP, HS
138	Vela SNR	8 ^h 32 ^m	– 44°	S	098-04	RG 630	60	14″.5	HS
139	Vela SNR	8 ^h 30 ^m	– 44°	S	{ IIa-O 102a-D 098-04 }	{ GG 385 GG 495 RG 630 }	{ 75 60 60 }	5″.1	HS
140	NGC 3132	10 ^h 4 ^m 9	– 40°11′	3.6	{ IIIa-J IIa-O 127-04 }	{ GG 385 GG 495 RG 630 }	{ 5 8 8 }	8″.4	SL
141	NGC 3132	10 ^h 4 ^m 9	– 40°11′	3.6	IIIa-J	UG 1	{ 0.08, 0.17, 0.33, 1.5*** }	9″	SL
142	Eta Carinae Nebula	10 ^h 46 ^m	– 60°	S	IIIa-F	RG 630	120	9″.2	OP
143	Eta Carinae Nebula	10 ^h 43 ^m 1	– 59°25′	3.6	IIIa-F	RG 630	20	1″.5	MT
144	Eta Carinae Nebula	10 ^h 43 ^m 1	– 59°25′	3.6	{ IIIa-J IIa-J 127-04 }	{ GG 385 OIII RG 630 }	{ 5 15 15 }	32″	SL, JS
145	IC 2944	11 ^h 33 ^m 5	– 62°44′	S	IIIa-F	RG 630	120	7″.3	GP

Plate	Object	R.A. (1950)	Decl.	Telescope or camera	Emulsion or detector	Filter	Exposure time in minutes	Plate scale 1 cm equal to	Observer
(1)	(2)	(3)	(4)	(5)	(6)	(7)	(8)	(9)	(10)
146	Thackeray's Globules	11 ^h 36 ^m 0	-63° 5'	3.6	IIIa-F	H _α	42	32''	BR
147	NGC 5367	13 ^h 54 ^m 7	-39°45'	S	IIIa-F	RG 630	120	4'.9	OP
148	NGC 3576	11 ^h 9 ^m 1	-61° 6'	S	IIIa-F	RG 630	120	2'.4	GP
149	Crux-Centaurus	13 ^h 40 ^m	-62°	H	EPD-200	-	70	47'	CM
150	Norma	16 ^h 5 ^m	-51°	H	EPD-200	-	70	47'	CM
151	-	-	-	-	-	-	-	-	-
152	Kappa Crucis	12 ^h 50 ^m 6	-60° 5'	S	IIa-O	GG 385	60	1'.2	HS
153	IC 4406	14 ^h 19 ^m 3	-43°55'	3.6	127-04	RG 630	20	24''	SL
154	Shapley 1	15 ^h 47 ^m 4	-51°21'	3.6	127-04	RG 630	60	20''	SL
155	Field in Norma-Ara	16 ^h 34 ^m	-48°	S	IIIa-F	RG 630	120	7'.0	GP
156	NGC 6188	16 ^h 35 ^m 9	-48°55'	3.6	{IIa-O IIa-D 098-04	{GG 385 GG 495 RG 630	{45 45 60	1'.7	RW
157	Scorpius-Sagittarius	17 ^h 28 ^m	-33°	H	EPD-200	-	90	47'	CM
158	Sagittarius-Scutum	18 ^h 18 ^m	-14°	H	EPD-200	-	90	47'	CM
159	NGC 6231 field	16 ^h 50 ^m	-42°	S	IIIa-F	RG 630	120	12'.5	GP
160	IC 4628	16 ^h 49 ^m 3	-40°18'	S	IIIa-F	RG 630	120	6'.8	GP
161	Bok Globule	17 ^h 19 ^m 1	-23°52'	S	IIIa-F	RG 630	120	1'.9	OP
162	NGC 6302	17 ^h 10 ^m 4	-37° 3'	3.6	127-04	RG 630	20	11''	SL
163	NGC 6334	17 ^h 17 ^m 2	-36° 1'	3.6	{IIa-O IIa-D 098-04	{GG 385 GG 495 RG 630	{45 45 60	1'.8	RW
164	NGC 6334	17 ^h 17 ^m 2	-36° 1'	3.6	098-04	RG 630	60	58''	RW
165	Nuclear Bulge	17 ^h 58 ^m	-34°	S	IIa-O	GG 385	60	8'.2	GP, OP
166	Galactic Centre	17 ^h 42 ^m 4	-28°55'	S	IIIa-F	RG 630	120	9'.4	GP
167	Baade's Window	18 ^h 0 ^m 4	-30° 2'	S	IIIa-F	RG 630	120	9'.3	GP
168	Obj. prism plate	18 ^h 17 ^m	-17°	S	IIIa-J	(3000-5000 Å)	120	6'.6	GP
169	M 8	18 ^h 1 ^m 6	-24°20'	3.6	127-04	RG 630	30	51''	SL
170	M 8 area	18 ^h 2 ^m	-24°	S	IIIa-F	RG 630	120	6'.8	GP
171	M 20	17 ^h 58 ^m 9	-23° 2'	3.6	127-04	RG 630	30	34''	SL
172	M 17	18 ^h 18 ^m 0	-16°12'	3.6	{IIa-O IIa-D 098-04	{GG 385 GG 495 RG 630	{45 45 60	1'.7	RW
173	M 55	19 ^h 36 ^m 9	-31° 3'	3.6	{IIa-O IIa-D 098-04	{GG 385 GG 495 RG 630	{45 45 60	1'.4	RW
174	NGC 5139	13 ^h 23 ^m 8	-47° 3'	1.5	IIIa-J	GG385	45	53''	BN
175	NGC 104	0 ^h 21 ^m 9	-72°21'	S	{IIa-O IIa-D IIIa-F	{GG 385 GG 495 RG 630	{60 40 120	58''	GP
176	IC 5148/50	21 ^h 56 ^m 5	-39°37'	3.6	127-04	RG 630	60	30'.5	SL
177	NGC 7293	22 ^h 26 ^m 9	-21° 3'	3.6	{IIa-O IIa-D 098-04	{GG 385 GG 495 RG 630	{45 45 60	1'.4	RW
178	Comet Halley	19 ^h 38 ^m	-26°	35 SLR	Perutz 100	-	70	1'.0	RH
179	Meteor trails	4 ^h 33 ^m	-34°	S	IIIa-F	RG 630	120	45''	OP
180	Satellite trails	5 ^h 44 ^m	-18°	S	IIIa-F	RG 630	120	3'.0	OP
181	(2100) Ra-Shalom	0 ^h 57 ^m 8	-33°56'	S	IIa-O	GG 385	60	1'.2	GP
182	(2340) Hathor	0 ^h 11 ^m 8	- 2°44'	S	IIa-O	GG 385	12	23''	RW
183	(2340) Hathor	0 ^h 13 ^m 3	- 3°18'	S	IIa-O	GG 385	10	23''	RW

Plate	Object	R.A. (1950)	Decl.	Telescope or camera	Emulsion or detector	Filter	Exposure time in minutes	Plate scale 1 cm equal to	Observer
(1)	(2)	(3)	(4)	(5)	(6)	(7)	(8)	(9)	(10)
184	(2340) Hathor	0 ^h 14 ^m 6	− 3°42′	S	IIa-O	GG 385	10	23″	GP
185	(2340) Hathor	0 ^h 15 ^m 9	− 4°6′	S	IIa-O	GG 385	8	23″	GP
186	(2101) Adonis	10 ^h 25 ^m 5	+ 11°32′	S	103a-O	GG 385	20, 20***	18″	HS
187	Minor planet trails	12 ^h 27 ^m	+ 1°	S	{ IIIa-J IIIa-J	{ GG 385 GG 385	{ 120 120	1.4	OP/HS
188	(2187) La Silla	8 ^h 31 ^m 1	+ 10°49′	S	IIa-O	GG 385	15	5.1	GP
189	(2146) Stentor	8 ^h 42 ^m 1	+ 8°29′	S	IIa-O	GG 385	15	19″	GP
190	Comet West 1975n	20 ^h 46 ^m	−43°	S	IIa-O	GG 385	60	5.4	GP
191	Comet West 1975n	21 ^h 50 ^m	+ 5°	35 SLR	EHS	—	5	53′	PS
192	Comet Schuster 1977o	23 ^h 28 ^m 0	−35°10′	3.6	IIIa-J	GG 385	60	17″	PL
193	Comet West 1978a	14 ^h 31 ^m 4	−12°55′	3.6	IIIa-J	GG 385	50	20″	AS/JS
194	Comet Bradfield 19791	22 ^h 23 ^m	−79°35′	3.6	IIIa-J	GG 385	5	42″	RW/GS
195	Comet Bradfield 19791	0 ^h 23 ^m	−75°48′	3.6	IIIa-F	RG 630	5	42″	GS
196	Comet Crommelin	3 ^h 54 ^m 9	−12°18′	S	098-04	GG 495	10	33″	HS
197	Comet Halley	6 ^h 57 ^m 6	+ 9°3′	1.5	CCD	—	45	1.6	HP
198	Comet Halley	23 ^h 53 ^m	+ 7°	S	IIa-O	GG 385	10	4.0	HS, GP
199	Comet Halley	20 ^h 38 ^m	−14°	WFCC	CCD	GG 495	9	18′	RW
200	Comet Halley	20 ^h 30 ^m	−15°	WFCC	CCD	IF 426 nm (CO ⁺)	45	20′	HP, RV
201	Comet Halley	20 ^h 26 ^m	−16°	GPO	{ IIa-O IIa-D 098-04	{ GG 385 GG 495 RG 630	{ 7 7 20	2.1	RW
202	Comet Halley	20 ^h 6 ^m	−19°	S	IIa-O	GG 385	25	12′	HS
203	Comet Halley	19 ^h 59	−21°	S	IIa-O	GG 385	30	12′	HS
204	Comet Halley	17 ^h 54	−42°	WFCC	CCD	GG 495	0.7	20′	BG

* Mosaic images, main data only

** Scale of full size panorama 1 cm = 3.2

*** Multiple exposures on single plate

Index of Objects

The Index is made up of Table 1, named objects; Table 2, Messier objects; and Table 3, NGC and IC objects. All references are to plate numbers, not to pages, and a reference is made whenever an object is mentioned in the plate text or is indicated in a figure belonging to the plate. Tables 1 and 2 contain cross-references between names, Messier and NGC/IC numbers. The Index does not contain stars and constellations.

Table 1. Named objects

Name	M	NGC	Plate
Adonis, minor planet			186
Andromeda Galaxy	31	224	4, 122
Antennae Galaxies		4038-39	92, 93
Baade's Window			167
Barnard's Loop			124, 125, 126
California Nebula		1499	122, 124
Carina dE Galaxy			69
Centaurus A		5128	12-15, 105
Centaurus Chain			104
Ceres, minor planet			181
Chi Persei Cluster		884	122
Coal Sack			50, 122, 133, 149, 150
Coma Cluster			94
Comet Bradfield 1979l			194, 195
Comet Crommelin			196
Comet Halley			178, 191, 196-204
Comet Schuster 1977 o			192, 193
Comet West 1975 n			190, 191
Comet West 1978 a			193
Crab Nebula	1	1952	139
Crab pulsar			139
Cygnus Loop		6992/95	122
30 Doradus Nebula		2070	51-54, 56-59
Eagle Nebula		IC2177	124
Eta Carinae Nebula		3372	50, 122, 133, 142-144, 148
Fornax Cluster			3, 4, 6, 7
Fornax dE Galaxy			70
Galactic Centre			166
Great Rift			122
Gum Nebula			58, 132, 134-138, 147
Hathor, minor planet			182-185
h Persei Cluster		869	122
Helix Nebula		7293	177
Horsehead Nebula			130, 135
Hourglass Nebula			169
Hyades			124

Name	M	NGC	Plate
Hydra I Cluster			9, 95
Irene, minor planet			177
Jewel Box		4755	133, 149, 152
Kappa Crucis Cluster		4755	133, 149, 152
Keyhole Nebula			144
Klemola 44			97
Lagoon Nebula	8	6523	158, 169, 170
Lambda Orionis Nebula			124, 125
Large Magellanic Cloud (LMC)			1, 50–63, 64, 87, 98, 122
La Silla, minor planet			188
Local Group			50–70, 92, 94
Magellanic Stream			64
North America Nebula		7000	122
Omega Centauri Cluster		5139	122, 174, 175
Omega Nebula	17	6618	158, 168, 172
Orion Nebula	42/43	1976/82	56, 122, 124–129, 142, 169, 172
Pavo Group			96
Pleiades	45		122, 124
Ra-Shalom, minor planet			181
Rosette Nebula		2237–39	122, 124
SagDIG			66, 92

Name	M	NGC	Plate
Sagittarius A			166
Sculptor dE Galaxy			68, 181
Sculptor Group			71, 74–77
SDIG			75
Seashell Galaxy			106, 107
Shapley 1			154
Small Magellanic Cloud (SMC)			50, 64, 65, 68, 175
Sombrero Galaxy	104	4594	16–19, 166
Southern Cross			50, 122, 149, 152
Southern Ring Galaxy			103
Stentor, minor planet			189
Summer triangle			122
Tarantula Nebula		2070	51–54, 56–59
Thackeray's Globules			145, 146
Trapezium			127
Trifid Nebula	20	6514	158, 170, 171
47 Tucanae Cluster		104	50, 175
Veil Nebula			122
Vela pulsar			139
Vela SNR			132, 138, 139
Virgo Cluster			94, 117
Whirlpool Galaxy	51	5194	91

Table 2. Messier-Objects

M	NGC	Name	Plate
1	1952	Crab Nebula	139
4	6121		122
6	6405		122, 157
7	6475		157, 165
8	6523	Lagoon Nebula	158, 169, 170
10	6254		122
11	6705		158
16	6611		158
17	6618	Omega Nebula	158, 168, 172
18	6613		158, 168
20	6514	Trifid Nebula	158, 170, 171
21	6531		158
22	6656		158
23	6494		158
24			158
25	IC 4725		158
26	6694		158
28	6626		158
31	224	Andromeda Galaxy	4, 122
33	598		71, 122
34	1039		122
35	2168		122, 124
36	1960		122, 124
37	2099		122, 124
38	1912		122, 124
41	2287		124
42/43	1976/82	Orion Nebula	56, 122, 124–129, 142, 169, 172
45		Pleiades	122, 124
46	2437		124
50	2323		124
51	5194	Whirlpool Galaxy	91
55	6809		173
62	6266		157
77	1068		22
78	2068		126
83	5236		47, 48, 71
84	4374		94
86	4406		94
87	4486		94, 117, 118
93	2447		124
98	4192		94
99	4254		94
104	4594	Sombrero Galaxy	16–19, 166

Table 3. NGC und IC Objects

NGC	Plate	NGC	Plate	NGC	Plate	NGC	Plate
55	76	1380A	3	2014	61	3316	95
87	81	1380B	3	2019	51	3336	95
88	81	1381	3	2020	61	3372	50, 122, 133, 142–144, 148
89	81	1386	3	2024	126		
92	81, 85	1387	3	2031	51	3532	133
104	50, 175	1389	3	2058	51	3576	148
134	23	1399	3	2065	51	3585	8
157	27	1404	3	2068	126	3590	148
220	64	1407	8	2070	51–54, 56–59	3766	133, 145
224	4, 122	1427	3	2099	122, 124	3923	8
242	64	1427A	3, 7	2100	51	4038–39	92, 93
247	77	1428	3	2107	51	4168	94
253	74	1433	8	2168	122, 124	4189	94
265	64	1437	3	2217	8	4192	94
289	44	1493	90	2237–39	122, 124	4206	94
300	71, 72	1494	90	2287	124	4212	94
330	64	1495	90	2323	124	4216	94
346	64	1499	122, 124	2437	124	4254	94
357	43	1647	124	2442	42	4267	94
361	64	1746	124	2447	124	4294	94
371	64	1808	30–32	2467	124, 131	4298	94
376	64	1809	62	2477	124	4299	94
411	64	1850	51	2539	124	4302	94
416	64	1854	51	2547	132	4313	94
419	64	1856	51	2548	124	4371	94
454	114	1872	51	2613	8	4374	94
458	64	1898	51, 60	2997	33, 34	4388	94
598	71, 122	1903	51	3109	49	4402	94
613	110–113	1912	122, 124	3114	133	4406	94
752	122	1913	51, 60	3132	140, 141	4435	94
869	122	1916	51	3136B	88	4438	94
884	122	1939	51	3285	95	4486	94, 117, 118
1039	122	1943	51	3285A	95	4517	187
1068	22	1952	139	3285B	95	4594	16–19, 166
1232	8	1960	122, 124	3293	142	4650	104
1350	3, 6	1973	126	3305	95	4650A	104, 105
1351	3	1976/82	56, 122, 124–129, 142, 169, 172	3307	95	4755	133, 149, 152
1351A	3			3308	95	4945	35
1365	3–6, 73	1984	51	3309	9, 10, 95	5068	8
1373	3	1986	51	3311	9, 10, 95,	5101	39, 40
1374	3	1987	51		97	5102	8
1375	3	1994	51	3312	95	5128	12–15, 105
1379	3	2004	51	3314	95	5139	122, 174, 175
1380	3	2005	51	3315	95	5194	91

Table 3 (continued)

NGC	Plate	NGC	Plate	NGC	Plate	NGC	Plate	IC	Plate	IC	Plate
5236	47, 48, 71	6231	157, 159	6522	167	6845	85	434	126, 130	4406	153
5291	106, 107	6242	157, 160	6523	158, 169, 170	6861	11	1274	170	4628	157, 159, 160
5292	106	6254	122	6528	167	6872	96	1275	170	4651	150
5302	106	6266	157	6530	169, 170	6876	96	1963	3	4662	8
5304	106	6268	160	6531	158	6877	96	2082	98	4678	170
5358	97	6281	157	6544	170	6880	96	2177	124	4685	170
5367	147	6300	41	6559	170	6887	21	2391	132	4710	8
5426	80	6302	157, 162	6611	158	6923	45	2488	132	4725	158
5427	80	6322	157	6613	158, 168	6992/95	122	2554	88	4970	96
5662	149	6334	157, 163, 164	6618	158, 168, 172	7000	122	2597	95	4972	96
5822	150	6357	157, 163	6626	158	7293	177	2602	133	4981	96
6025	150	6388	157	6656	158	7314	26	2872	145	5148/50	176
6067	150	6405	122, 157	6684	38	7496	46	2944	145, 146	5152	37
6087	150	6425	166	6694	158	7742	20	2948	133, 145	5174	91
6121	122	6438	84	6705	158	7764	8	4327	106	5175	91
6124	150	6438 A	84	6744	28	7769	24	4329	106	5267	8
6134	155	6451	166	6769	78, 79	7793	8, 37, 73	4329 A	106		
6164-65	155	6453	165	6770	78, 79						
6188	121, 150, 155, 156	6475	157, 165	6771	78, 79						
6193	150, 155, 156	6494	158	6809	173						
6221	29	6514	158, 170, 171	6814	25						
		6520	167	6822	66, 67, 92						